

## Errata

**Title & Document Type:** 3048A Phase Noise Measurement System Reference Manual

**Manual Part Number:** 03048-90002

**Revision Date:** September 1989

---

### HP References in this Manual

This manual may contain references to HP or Hewlett-Packard. Please note that Hewlett-Packard's former test and measurement, semiconductor products and chemical analysis businesses are now part of Agilent Technologies. We have made no changes to this manual copy. The HP XXXX referred to in this document is now the Agilent XXXX. For example, model number HP8648A is now model number Agilent 8648A.

### About this Manual

We've added this manual to the Agilent website in an effort to help you support your product. This manual provides the best information we could find. It may be incomplete or contain dated information, and the scan quality may not be ideal. If we find a better copy in the future, we will add it to the Agilent website.

### Support for Your Product

Agilent no longer sells or supports this product. You will find any other available product information on the Agilent Test & Measurement website:

[www.tm.agilent.com](http://www.tm.agilent.com)

Search for the model number of this product, and the resulting product page will guide you to any available information. Our service centers may be able to perform calibration if no repair parts are needed, but no other support from Agilent is available.

03048 V.1

# HP 3048A Phase Noise Measurement System

---

## Reference Manual

---



Manual Boxed Set HP Part 03048-90002 (Reference Manual  
(03048-90002) not available separately)

---

## Notice

This document contains proprietary information which is protected by copyright. All rights are reserved. No part of this document may be photocopied, or reproduced without prior written consent of Hewlett-Packard Company.

This material may be reproduced by or for the U.S. Government pursuant to the Copyright License under the clause at DFARS 52.227-7013 (APR 1988).

Copyright © 1987 Hewlett-Packard Company

**Hewlett-Packard Company**  
**Spokane Division**  
24001 E. Mission  
Liberty Lake, WA 99019-9599, U.S.A.

---

## Software Versions

This manual applies directly to instruments with software version numbers:

HP 3048A Software Version: REV: A.02.00 and Above

---

## Printing History

First Edition: 6/88 - Printed in U.S.A.  
Second Edition: 9/89 - Printed in U.S.A.

*rev.05SEP89*

# Volume 1 Contents

---

## Softkey Index

### Chapter 1, General Information

Introduction . . . . .	1-1
------------------------	-----

### Chapter 2, Measurement Definitions

Introduction . . . . .	2-1
Type/Range . . . . .	2-3
Instr. Params (Instrument Parameters) . . . . .	2-13
Calibr Process (Calibration Process) . . . . .	2-41
Source Control . . . . .	2-101
Define Graph . . . . .	2-115
Test Files . . . . .	2-121

## **Chapter 3, Graphics Functions**

Introduction . . . . .	3-1
Param Summary (Parameter Summary) . . . . .	3-3
Define Graph . . . . .	3-19
Marker ON/OFF . . . . .	3-23
Slope Lines . . . . .	3-25
Plotters . . . . .	3-29
Plot w/o Spurs (Plot without Spurs) . . . . .	3-31

## **Chapter 4, Computed Outputs**

Introduction . . . . .	4-1
Integr Noise (Integrated Noise) . . . . .	4-3
Sigma vs. Tau . . . . .	4-9
Normalized Bandwidth . . . . .	4-15
3 Osc. Compar. (Three Oscillator Comparison) . . . . .	4-19
2 Osc. Compar. (Two Oscillator Comparison) . . . . .	4-23
Spur List . . . . .	4-27

# Volume 2 Contents

---

## Chapter 5, Special Functions

Introduction . . . . .	5-1
Test Mode . . . . .	5-3
Carrier Type . . . . .	5-9
FFT Segmnts (HP 3561A Segments) . . . . .	5-13
RF Segmnts (RF Spectrum Analyzer Segments) . . . . .	5-23
Noise Monitor/NewNse Monitor . . . . .	5-29
11848A Control . . . . .	5-35
3048A Sys Chk (3048A System Checks) . . . . .	5-43

## Chapter 6, System Configuration

Introduction . . . . .	6-1
RF Sources . . . . .	6-3
RF Analyzers . . . . .	6-23
Down Converters . . . . .	6-31
Frequency Counters . . . . .	6-45
Digital Voltmeters . . . . .	6-47
Controllers . . . . .	6-49
Mass Storage Devices . . . . .	6-51
Plotter . . . . .	6-55
System Clock . . . . .	6-59
Load Alternate Program . . . . .	6-61
Additional Equipment . . . . .	6-63

## Chapter 7, Quick Reference

1	Approximate HP 3048A Phase Noise Floor vs. R Port Signal Level . . . . .	7-2
2	HP 3048A Phase Noise Floor and Region of Validity of $\mathcal{L}(f) = \frac{S_{\phi}(f)}{2}$ . . . . .	7-4
3	Phase Noise Level of Various HP Sources . . . . .	7-6
4	Increase in Measured Noise as Reference Source Noise Approaches DUT Noise . . . . .	7-8
5	Approximate Sensitivity of Delay Line Discriminator . . . . .	7-10
6	AM Calibration . . . . .	7-12
7	Voltage Controlled Source Tuning Requirements . . . . .	7-14
8	Voltage Tuning Range vs. Center Voltage . . . . .	7-16
9	Tuning Characteristics of Various VCO Source Options . . . . .	7-18
10	Peak Tuning Range Required Due to Noise Level . . . . .	7-22
11	Phase Lock Loop Bandwidth vs. Peak Tuning Range . . . . .	7-24
12	HP 3048A Noise Floor Limits Due to Peak Tuning Range . . . . .	7-28

## Chapter 8, Messages

Introduction . . . . .	8-1
Numbered Error Messages . . . . .	8-2
Unnumbered Error Messages . . . . .	8-19
Reference Messages . . . . .	8-21
Warning Messages . . . . .	8-28
Status Messages . . . . .	8-29

# Index

---

0.001 Hz offset measurements, 5-20  
1 Hz bandwidth, 4-15  
2 device comparison, *see*: 2 Osc. Compar.  
2 Osc. Compar., 4-23  
2 oscillator comparison, *see*: 2 Osc. Compar.  
2 source comparison, *see*: 2 Osc. Compar.  
3 device comparison, *see*: 3 Osc. Compar.  
3 Osc. Compar., 4-19  
3 oscillator comparison, *see*: 3 Osc. Compar.  
3 source comparison, *see*: 3 Osc. Compar.  
10 MHz A used with HP 8662A/63A, 6-11, 6-13  
10 MHz B used with HP 8662A/63A, 6-14  
11848A Control, 5-35  
3048A Sys Chk, 5-43

## A

---

A vs. B file, 4-21, 4-25  
A vs. C file, 4-21  
absolute system noise floor HP 11729C, 6-35  
acc'y spec degrad, 2-54, 3-9  
Access Graph, 5, 3-1  
accuracy, 1-12. *see also*: specifications  
accuracy specification degradation, 2-54, 3-9  
adjustments (HP 11848A), 5-44. *see also*: HP 3048A Calibration Manual  
advanced user, 5-1  
Allan Variance, 4-10  
AM calibration, equivalent  $k_{\Phi}$ , 4-89, 7-12



- AM Detector, 2-8, 2-89, 6-63
  - Constant, 2-89
  - filter, 6-63
- AM measurements HP 11729C, 6-43. *see also*: HP 3048A Operating Manual
- AM Noise,
  - instrument parameter, 2-38
  - calibration process, 2-89
  - measurement type, 2-7
- AM rejection, 2-7
- AM sensitivity, 2-89
- amplifiers, 2-6, 6-64
- assumed pole, 2-55, 3-11, 5-5
- ATTEN1, 5-37
- ATTEN2, 5-37
- ATTEN3, 5-37
- attenuators, 6-63
- Aux Monitor port, 2-46, 6-46
- averages,
  - FFT, 2-12, 5-15
  - span marking, 4-28
- averaging, 2-12, 5-15

## **B**

---

- BW, 4-16, 5-16, 5-26
- B vs. C file, 4-21
- backup software files, *see*: copying files
- bandwidth, 5-16, 5-26
  - 0 Hz, 4-17
  - normalized, 4-15
- baseband noise measurement type, 2-10
- beatnote, 2-46, 7-24. *see also*: HP 3048A Operating Manual
- beatnote calibration w/o PLL, 2-65
- bin, 4-5
- block diagram HP 11848A, 5-42

## C

---

- cal system, 7, 5-44. *see also*: HP 3048A Calibration Manual
- CALDATAHI, 5-45. *see also*: HP 3048A Calibration Manual
- CALDATALO, 5-45. *see also*: HP 3048A Calibration Manual
- Calibr Process, 2-41
- calibration,
  - constant, *see*: Phase Detector Constant; VCO Tuning Constant; Discriminator Constant, AM Detector Constant
  - data, *see*: HP 3048A Calibration Manual
  - periodic, *see*: HP 3048A Calibration Manual
  - process, 2-41
  - spur, *see*: double sided spur; single sided spur; spur test tone, 6-25
- capture range, 7-14. *see also*: HP 3048A Operating Manual
- carrier frequency, 3-5, 3-15
  - AM Noise, 2-38
  - w/FM Discriminator, 2-35
  - w/PLL, 2-14
  - w/o PLL, 2-31
- carrier noise test set (HP 11729C), 6-32
- carrier type, 5-9
- center voltage, 2-17, 3-6, 7-16
- center voltage of VCO tuning curve, 2-17, 3-6, 7-16
- clearing CALDATA, 7, 5-46
- clip left, 3-26
- clip right, 3-26
- closed PLL bandwidth, 3-10, 5-5
- comb line frequencies, 6-33
- Computed Outputs, 4-1
- computers, 1-9, 6-49
- computer accessories, 1-9
- controllers, 6-49
- copying files, 6-52
  - test files, 2-124
  - result files, 3-15

- counters, 6–45
- couplers, 2–73, 6–64
- Create Dir. (create directory), 2–126, 3–18
- Current Detector Constant, 2–44
  - w/o PLL, 2–59
- Cutler, 4–11
- cutoff frequency ( $f_h$ ), 4–9
- CW Carrier Type, 5–9

## D

---

- DAC1, 5–37
- DAC2, 5–37
- DAC3, 5–37
- Dac tests, 5–44
- data files, 6–52. *see also*: test files; result files
- Data Type, 2–117, 4–4
- dBc/Hz, 4–16
- dc block, 2–8, 6–64
- DC FM,
  - HP 8662A/HP8663A, 2–29, 6–10
  - deviation, 2–16. *see also*: VCO Tuning Constant
- decr. hpf, 8, 5–30
- decr. lpf, 8, 5–30
- Default,
  - Test File, 2–122
  - Result File, 3–14
- Define Graph, 2–115, 3–19
- Define Msrmnt, 2–1
- Definite Integral Value, 4–3
- delay line discriminator, 2–79, 2–109, 7–10
- delete entry, 8, 4–4
- delete file, 2–123, 3–15
- delete segment, 5–19
- derive from measured +/– dc peak w/o PLL, 2–61
- Detect. Input Frq., 3–5. *see also*: Detector/Discr.

- Detector Constant, 3-7, 7-2. *see also*: Phase Detector Constant
  - estimating, 2-91, 7-2
  - w/PLL, 2-43
- detector selection,
  - AM Noise, 2-39
  - w/FM Discriminator, 2-37
  - w/PLL, 2-26
  - w/o PLL, 2-33
- Detector/Discr.,
  - Input Frequency AM, 2-39
  - Input Frequency FM Discriminator, 2-36
  - Input Frequency w/PLL, 2-15
  - Input Frequency w/o PLL, 2-32
- Device Under Test (DUT), 2-102, 3-11
- digital voltmeter, 6-47
- direct comparison, 4-19
- directional coupler, 2-73, 6-64
- directory, 2-126, 3-18
- disc drives, 1-10, 6-51
- discontinuity, *see*: HP 3048A Operating Manual
- discriminator (delay line), 2-79, 7-11
- discriminator sensitivity, *see*: Discriminator Constant
- Discriminator Constant, 2-75
  - estimating, 2-78
- display resolution for the HP 3561A, 5-17
- dividers, 2-6
- Documentation Update Service, 1-4
- documentation updating, 1-4
- Double Sided Spur,
  - calibration tone, 6-29
  - AM Noise, 2-93
  - w/FM Discriminator, 2-81
  - w/o PLL, 2-67
- down converter, 3-12, 6-31
- Drift Tracking Range, 2-19, 7-14

DUT, 2-102, 3-11  
DUT source, 2-108  
dynamic signal analyzer, *see*: HP 3561A

## E

---

EFC, 6-8, 7-18  
enhanced tuning range, 2-27, 7-18  
entered K\_VCO, 3-5. *see also*: VCO Tuning Constant  
erase lines, 3-26  
Error Messages, 8-2  
Eval Allan, 9, 4-10  
eval intgrl, 10, 4-4  
eval sigma, 10, 4-10  
external timebase, 3-11. *see also*: external reference tuning  
external controller, 6-2  
external detectors,  
    phase, 2-26  
    w/FM Discriminator, 2-37  
    w/PLL, 2-26  
    w/o PLL, 2-34  
external reference tuning, 6-12

## F

---

$f_h$ , 4-9  
F SWITCH NUMBER, 5-38  
FFT Analyzer, 6-2  
FFT Segment, 5-13  
FFT Segmnts, 5-13  
filters, 2-6, 6-63  
flicker of freq., 4-13  
flicker of phase, 4-13  
floppy disc, 6-51  
FM deviation, 2-16, 2-85. *see also*: VCO Tuning Constant  
FM discriminator calibration, 2-75  
FM rate, 2-85

FM rate and deviation calibration w/FM discriminator, 2-85  
FM spectral density, 2-117, 3-21  
Fnctl. Chk., 10, 5-44  
fractional frequency deviation, 4-9  
freeze files, 10, 4-21, 4-25  
frequency counter, 6-2, 6-45  
frequency fluctuations, 2-76  
frequency multipliers, 2-6  
frequency offset range, 1-3, 5-20  
frequency range, 1-12, 2-12, 5-25  
function generator, 6-2  
functional checks, 10, 5-44

## **G**

---

GAIN1, 5-37  
GAIN2, 5-37  
GAIN3, 5-37  
General Information, 1-1  
graph,

- AM calibration, equivalent  $k_{\Phi}$ , 7-12
- center voltage, 3-6, 7-16
- peak tuning range noise floor, 2-21, 7-28
- peak tuning range required, 2-23, 7-22
- phase lock loop bandwidth, 2-22, 7-24
- VCO tuning characteristics, 2-50, 7-18
- voltage controlled source tuning requirements, 2-19, 7-14

Graph Type, 2-117, 3-21  
Graphic Functions, 3-1

## **H**

---

H SWITCH NUMBER, 5-38  
hard copy, 10, 3-26  
hard disc, 6-51  
HEWLETT-PACKARD FACTORY (test file), 2-122  
HP 11729C, 1-19, 6-20, 6-31

HP 11729C specs, 4, 6-33  
HP 11808A, 6-61  
HP 11848A block diagram, 5-42  
HP 11848A Interface, 1-2, 5-35, 5-43  
HP 11848A LNA, 3-12, 5-9, 7-2  
HP 3048A, 1-2  
HP 3048A option K21, 2-8, 6-63  
HP 3048A reference source options, 1-7  
HP 3048A spectrum analyzer options, 1-8  
HP 3048A system options, 1-8  
HP 310, 6-49  
HP 320, 6-49  
HP 33330C low barrier schottkey diode detector, 2-91 6-63, 7-12  
HP 3561A dynamic signal analyzer, 1-2, 2-8, 5-13, 5-30  
HP 3585A/B, 6-24  
HP 5316A/B, 6-45  
HP 5343A, 6-45  
HP 5384A, 6-45  
HP 5385A, 6-45  
HP 5386A, 6-45  
HP 71000, 6-24  
HP 82315B, 6-49  
HP 8566A/B, 6-24  
HP 8567A, 6-24  
HP 8568A/B, 6-24  
HP 8642A, 6-16  
HP 8656B, 6-18  
HP 8656A, 6-19  
HP 8662A/HP 8663A, 6-7  
HP 9836A, 6-49  
HP 9836C, 6-49  
HP EXAMPLE (test file), 2-122  
HP-IB address, 6-0. *see also*: HP 11848A Service Manual  
HP TEST (test file), 2-122

## I

---

Ignore Out Of Lock Test Mode, 10, 5-8  
injection locking, 2-48, 2-56, 7-22. *see also*: HP 3048A Operating Manual  
Instr. Params, 2-13  
Instrument Parameters, 2-13  
Int. Adj'mt, 5-44. *see also*: HP 11848A Serv./HP 3048A Cal. Manuals  
Integr Noise, 4-3  
Integrated Noise, 4-3  
interface, *see*: HP 11848A  
isolation, 2-48

## J

---

Jitter, 4-29

## K

---

$k_d$ , *see*: Discriminator Constant  
K\_Detector method, 3-7  
known osc., 4-24  
 $k_\phi$ , 2-43. *see also*: Phase Detector Constant  
kv [Hz/v], *see*: VCO Tuning Constant  
K\_VCO method, 3-8. *see also*: VCO Tuning Constant

## L

---

$\mathcal{L}(f)$ , 2-117, 3-21, 4-4  
lag-lead filter, 5-38, 7-22  
line stretcher, 2-61, 2-82, 2-108, 6-64  
LNA, 3-12, 5-9, 5-42, 7-2  
Load Alt., 11, 6-61  
load alternate program, 6-61  
load CALDATA, 11, 5-46  
load file, 11, 2-126, 3-14  
load file test file, 2-123  
lock loop, 11, 5-30



loop holding range, *see*: Drift Tracking Range  
loop suppression, 2-54, 3-9  
loop suppression verification, 2-54, 3-9  
Low Noise Amplifier, 3-12, 5-9, 5-42, 7-2

## **M**

---

maximum x coordinate, 3-20  
manual updates, 1-4  
Marker,  
    (RF Analyzer), 12, 5-31  
    3561A, 12, 5-31  
    ON/OFF, 12, 3-23  
mass storage, 2-123, 3-14 6-51  
mass storage devices, 1-10, 6-51  
maximum acceptable clipping, 5-11  
maximum y coordinate, 3-20  
measure the detector constant w/PLL, 2-47  
measurement,  
    averages, 2-12, 4-28, 5-15  
    bandwidth, 5-16, 5-26  
    definitions, 2-1  
    FFT, 5-16  
    range, 2-12, 5-20  
    resolution, 5-14, 5-25  
    software, 1-2  
    time, 5-14  
    type, 2-4, 3-4  
Messages, 8-1  
    Numbered Error, 8-2  
    Reference, 8-21  
    Status, 8-29  
    Unnumbered Error, 8-19  
    Warning, 8-28  
meter, 2-49, 2-88  
meter sensitivity, 2-49, 2-88

microwave phase detector, *see*: Option 201  
minimum averages, 3-4  
minimum x coordinate, 2-116, 3-20  
minimum y coordinate, 2-117, 3-20

mixer sensitivity, *see*: Phase Detector Constant  
modulation analyzer, 2-67, 2-93, 6-63  
move down, 3-26  
move up, 3-26  
multimeter, 6-47

## **N**

---

N, 4-9  
National Bureau of Standards Traceability NBS, 1-11  
new line, 3-26  
New Noise Monitor, 12, 5-30  
New Measurement, 12. *see also*: HP 3048A Operating Manual  
next page, 13, 3-14  
next type, 13, 2-4  
Noise, 4-17  
data plotted in a 0 Hz bandwidth, 4-17  
floor level w/PLL, 2-20, 7-28  
Input, 2-47  
power, 4-7  
Measurement Using the HP 3561A Only measurement type, 2-8  
voltage, 2-8, 2-10  
voltage measurements, *see*: baseband noise measurement type  
Noise Monitor, 5-29  
Noise Monitor/Newnse Monitor, 5-29  
Normal Test Mode, 5-4  
Normalized Bandwidth, 4-15  
Non-linear Tuning Constant, 2-24

## **O**

---

offset frequency range, 1-12, 2-12, 5-20, 5-25  
Omit Spurs, 13, 4-4, 4-10  
One Osc., 4-21, 4-25  
Operator's Training, 1-2  
Option 001, 1-7  
Option 002, 1-7

- Option 003, 1-7
- Option 004, 1-7
- Option 005, 1-7
- Option 006, 1-7
- Option 101, 1-8
- Option 110, 1-8
- Option 201, 1-8
- Option 202, 1-8
- Option 910, 1-8
- Out of Lock, 5-8, 6-48. *see also*: HP 3048A Operating Manual
- overload, 2-112, 6-48

## **P**

---

- panel meter, 2-49, 2-84
- Param Summary, 3-3
- Parameter Summary, 3-3
- Parm\_Dir, 2-126
- Parm\_(number), 2-124
- peak deviation, 2-16. *see also*: VCO Tuning Constant
- peak phase deviation, 2-69
- peak tuning range, 2-18, 3-10
  - maximum HP 11729c, 6-41
  - noise floor, 7-28
  - required, 7-22
- peak volts, 2-61
- Perf. Tests, 14, 5-44, 6-29
- Performance Tests, 14, 5-44, 6-29
- performance verification capabilities, 5-43
- Phase Detector, 3-7
  - Constant w/PLL, 2-43
  - Constant w/o PLL, 2-57
  - sensitivity, *see*: Phase Detector Constant
- phase lock loop bandwidth, 2-18, 2-22, 7-24, 7-26
- phase lock loop suppression, 2-54, 5-4
- phase modulation spectral density, 2-117, 3-21

Phase Noise,  
  of various HP sources, 6-3, 7-6  
  Using an FM Discriminator, 2-35  
  Using a Phase Lock Loop measurement type, 2-4  
  Without Using a PLL, 2-31  
  Without Using a PLL measurement type, 2-6  
phase shifter, 2-108, 6-64  
phase slope, 2-43, 3-7, 7-4. *see also*: Phase Detector Constant  
PLL BW, 2-23, 2-54, 7-24  
PLL suppression curve, 5-5  
Plot W/O Spurs, 14, 3-31, 3-32  
plot without spurs, 14, 3-31 3-32  
plotter, 6-2, 6-55  
plotters (outputting), 3-29  
plotter pens, 6-56  
power meters, 6-63  
power splitters, 6-64  
printer, 1-10, 6-2  
printers/plotters, 1-10, 6-55  
PTR, 2-18, 3-10, 7-22  
Pulsed Carrier Type, 5-9

## **Q**

---

quadrature meter, *see*: meter  
Quick Reference, 7-1

## **R**

---

Random Walk of Freq., 4-13  
Read Dir, 15, 2-123, 3-15  
real time, 5-29. *see also*: Noise Monitor  
real time noise measurements, 5-32  
reference line, *see*: specifications lines; slope lines  
Reference Messages, 8-21  
Reference Noise vs. DUT Noise, 7-8  
Reference Source, 3-11

region of validity, 7-4  
relation of  $\mathcal{L}(f)$  to Allan Variance, 4-13  
remove line, 16, 3-26  
repeat measurement, *see*: HP 3048A Operating Manual  
residual (two-port), 2-6  
resolution, 5-25  
resu\_, 3-15  
Result Files, 3-13  
return loss noise input, 2-49  
RF (spectrum) analyzer, 5-23, 6-2, 6-23, 6-25  
RF segment table, 5-24, 6-25  
RF segmnts, 5-23  
RF source, 6-2  
rms modulation, 4-3

## S

---

segment table, 5-23  
    increasing resolution, 5-21  
    measurement time, 5-19  
    specifying offsets, 5-22  
SELECTED K SWITCHES, 5-38  
SELECTED L SWITCHES, 5-38  
SELECTED S SWITCHES, 5-38  
Set Line, 3-26  
Sigma vs. Tau, 4-9  
signal level, 7-2  
single point, 5-29. *see also*: Noise Monitor  
Single Sided Spur,  
    calibration tones, 6-29  
    AM Noise, 2-97  
    w/o PLL, 2-71  
Single-Sideband Phase Noise, 2-117, 3-21, 4-4  
Slope Lines, 3-25  
slope versus maximum tau, 4-12  
small angle criteria, 2-87

small angle criteria  $\mathcal{L}(f)$ , *see*: region of validity  
 $s_{\nu}(f)$ , 2-117, 3-21, 4-4  
 Software Materials Subscription (SMS), 1-5  
 Software Notification Service (SNS), 1-5  
 Software Release Bulletin, 1-6  
 Software Status Bulletin, 1-6  
 Software Updating, 1-5  
 Solve A,B,C, 4-21  
 Solve for B, 4-25  
 Source Drift (see Drift Track Range), 2-19  
 span, 5-31  
 Spec Lines, 2-118  
 Special Functions, 5-1  
 Specifications, 1-11  
 Specification Lines, 2-118  
 Spectral Density,  
     of Fractional Frequency Fluctuations, 2-117, 3-21, 4-4  
     of Frequency Fluctuations, 4-4  
     of Phase Fluctuations, 4-4  
 spectrum analyzer, 1-10, 6-2  
     output HP 11848A, 6-29  
     phase detector output, 6-25  
 $S_{\Phi}(f)$ , 2-117, 3-21, 4-4  
 Spur List, 4-27  
 spur marking criteria, 4-28  
 Spur Test, 5-44. *see also*: HP 3048A Calibration Manual  
 SRB, 1-6  
 SRM, 6-51  
 SSB, 1-6  
 Start Offset Freq, 3-4  
 Status Messages, 8-29  
 Stop Offset Freq, 3-4  
 Store File, 2-125, 3-15  
 sweep time, 5-26  
 switch (refer to 11848A control), 5-35

$S_y(f)$ , 2-117, 3-21, 4-4  
System Config, 6-1  
System Clock, 6-59  
System Configuration, 6-1

## T

---

t, 4-9  
tau ( $\tau$ ), 4-9  
table of data points for supported analyzers, 4-6  
Take Sweep, 19, 5-31  
Test Files, 2-121  
    loading, 2-126  
    storing, 2-125  
Test Mode, 5-3  
Test Result File, 3-13  
Three Osc. Comparison, *see*: 3 Osc. Compar.  
Time Record Length, 5-17  
Title, 2-116, 3-20  
Troubleshooting, *see*: HP 3048A Cal./HP 11848A Serv. Manuals  
Trouble Shoot Test Mode, 5-4  
tune port input resistance, 2-18, 3-8  
tune port resist, 2-18, 3-8  
tune voltage output port on the rear panel, 2-17  
Tune Voltage Range, 2-17, 3-6  
Tune Voltage Rnge, 2-17, 3-6  
Tuning,  
    Constant, 2-50. *see also*: VCO Tuning Constant  
    Curve, *see*: VCO Tuning Constant  
    sensitivity, *see*: VCO Tuning Constant  
    slope, *see*: VCO Tuning Constant  
Two Osc. Comparison, *see also*: 2 Osc. Compar.  
Two Port (residual), 2-6  
Type/Range, 2-3



## U

---

uncal light, 6-29  
unmarked spurs, 4-22, 4-26, 4-28  
Unnumbered Error Messages, 8-19  
Update Dir, 2-123, 3-15

## V

---

$V/\sqrt{Hz}$ , 2-75  
V/Rad, 2-57  
VCO slope, *see*: VCO Tuning Constant  
VCO tune port input resistance, 2-18  
VCO Tuning Constant, 2-16, 2-50, 3-8, 5-8, 7-18  
VCO tuning linearity, 2-24  
Vectra Viper, 6-49  
video bandwidth, 5-26  
VNOMS, 5-45. *see also*: HP 3048A Calibration Manual  
Voltage Controlled Source Tuning Requirements, 7-14  
Voltage Tuning Range of VCO, 2-17  
Voltmeter, 6-2, 6-47  
VTR, 2-17

## W

---

Warning Messages, 8-28  
white freq., 4-13  
white phase, 4-13

## X

---

x coordinate, 2-116

## Y

---

y coordinate, 2-117

# Softkey Index

---

This section includes a Softkey Map and Softkey Descriptions Table. The Softkey Map provides an overview of the HP 3048A's softkey menu structure.

The softkeys are listed in alphabetical order in the Softkey Description Table. The softkey descriptions briefly describe the function of each softkey. References to additional information are included in the table.

**Softkey Map** ..... pg. 3  
**Softkey Descriptions Table** ..... pg. 4

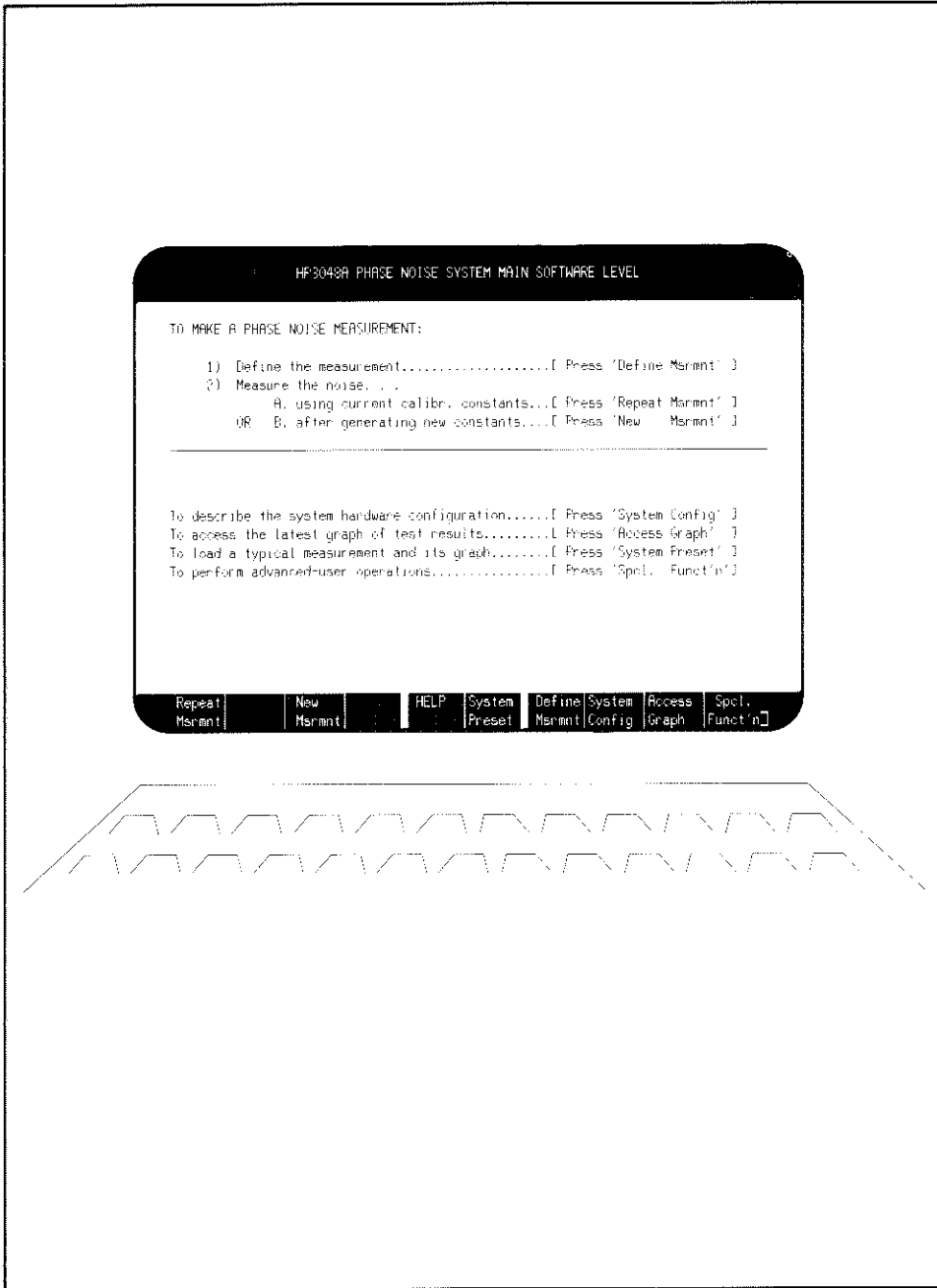

Figure 1. Main Software Level Display

# HP3048A Phase Noise System Main Software Level

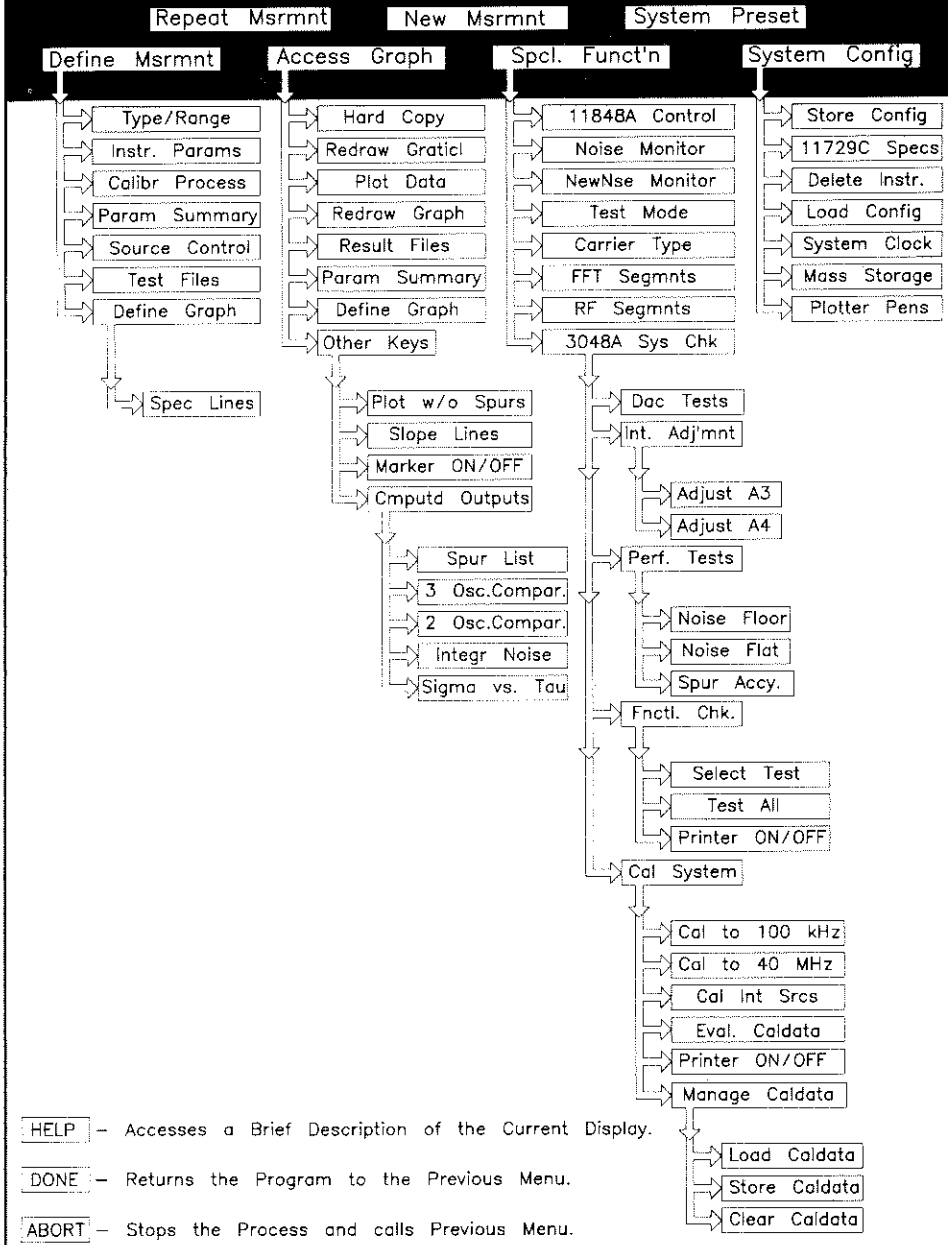

Figure 2. Softkey Map

**Table 1. Softkey Descriptions (1 of 17)**

<b>Key Name</b>	<b>Description</b>	<b>Chapter</b>
<b>0 to 100 kHz</b>	Selects the CALDATALO calibration data for storing, loading, or zeroing.	5 Special Functions
<b>.1 to 40 MHz</b>	Selects the CALDATAHI calibration data for storing, loading, or zeroing.	5 Special Functions
<b>2 Osc. Compar.</b>	Determines the noise level of a single device using two devices.	4 Computed Outputs
<b>3 Osc. Compar.</b>	Determines the noise level of each of three devices.	4 Computed Outputs
<b>3048A Sys Chk</b>	Accesses performance testing and calibration procedures for the HP 11848A Phase Noise Interface.	HP 3048A Calibration Manual
<b>3561A Span</b>	Steps through the measurement ranges defined for the HP 3561A in the FFT Segment Table.	5 Special Functions
<b>11729C Specs</b>	Accesses the display for specifying the HP 11729C carrier noise comb line filters.	6 System Configuration
<b>11848A Control</b>	Allows manipulation of the internal hardware of the HP 11848A Phase Noise Interface.	5 Special Functions

**Table 1. Softkey Descriptions (2 of 17)**

Key Name	Description	Chapter
<b>Access Graph</b>	Displays the noise graph that is presently stored in memory and accesses the Graphics Functions and Computed Outputs Functions. Allows you to perform the following functions: <ul style="list-style-type: none"> <li>● Access the Parameter Summary, a summarization of the measurement definitions used to obtain the current measurement results. (Parm Summary)</li> <li>● Access files of measurement results. (Result Files)</li> <li>● Place marker on the measurement graph. (Marker)</li> <li>● Place slope lines on the measurement graph. (Slope Lines)</li> </ul>	3 Graphics Functions
	<ul style="list-style-type: none"> <li>● Display and plot measurement results in various bandwidths.</li> <li>● List spurs found in a measurement. (Spur List)</li> <li>● Numerically manipulate the measurement results to generate Sigma vs. Tau (Allen variance), Integrated Noise and Three Oscillator Comparisons.</li> </ul>	4 Computed Outputs
<b>Adjust A3</b>	Selects the Adjustment procedure for the HP 11848A A3 Assembly.	HP 3048A Calibration Manual
<b>Adjust A4</b>	Selects the Adjustment procedure for the HP 11848A A4 Assembly.	HP 3048A Calibration Manual
<b>AM Detect.</b>	Configures the AM Detector in the Source Control display.	2 Meas. Definitions
<b>AUX. Caldata</b>	Causes cal data generated by the Noise Flatness Performance Test to be erased from memory when using Manage Cal Data.	5 Special Functions

**Table 1. Softkey Descriptions (3 of 17)**

<b>Key Name</b>	<b>Description</b>	<b>Chapter</b>
<b>A vs. B File</b>	Accesses the Result File for the 3 Oscillator Comparison, and displays all files. The user is required to select the file that contains the results from the first pair of sources.	4 Computed Outputs
<b>A vs. C File</b>	Accesses the Result File for the 3 Oscillator Comparison, and displays all files. The user is required to select the file that contains the results from the second pair of sources.	4 Computed Outputs
<b>B vs. C File</b>	Accesses the Result File for the 3 Oscillator Comparison, and displays all files. The user is required to select the file that contains the results from the third pair of sources.	4 Computed Outputs
<b>Cal 10A</b>	Perform the VNOM calibration for the HP 11848A 10 MHz A VCO.	HP 3048A Calibration Manual
<b>Cal 10B</b>	Perform the VNOM calibration for the HP 11848A 10 MHz B VCO.	HP 3048A Calibration Manual
<b>Cal 400</b>	Perform the VNOM calibration for the HP 11848A 350-500 MHz VCO.	HP 3048A Calibration Manual
<b>Cal to 100 kHz</b>	Perform the routine to generate new CALDATA LO.	HP 3048A Calibration Manual
<b>Cal to 40 MHz</b>	Performs the routine to generate new CALDATA HI.	HP 3048A Calibration Manual
<b>Cal All Srcs</b>	Performs the routine for calibrating all of the VNOMS (10 MHz A, 10 MHz B, and 250-400 MHz).	HP 3048A Calibration Manual

**Table 1. Softkey Descriptions (4 of 17)**

<b>Key Name</b>	<b>Description</b>	<b>Chapter</b>
<b>Cal Int Srcs</b>	Perform the routine to generate new VNOMS. (Nominal voltages to set the HP 11848A Internal Sources)	HP 3048A Calibration Manual
<b>CAL Source</b>	Configures the Calibration Source in the Source Control Diagram	2 Meas. Definitions
<b>CAL System</b>	Enables generation of CALDATA LO, CALDATA HI, and VNOMS. Also enables the loading of storing of calibration files.	5 Special Functions
<b>Calibr Process</b>	Accesses the menu for defining the measurement calibration from the Measurement Definition display.	2 Meas. Definitions
<b>Carrier Type</b>	Allows you to select CW or PULSED carrier (Carrier Type should normally be set to CW for non-pulsed noise measurements).	5 Special Functions
<b>Center Voltage</b>	Increments the HP 11848A Tune Voltage Output in 50 mV steps for the Connect Diagram Display.	2 Meas. Definitions
<b>SHIFT Center Voltage</b>	Decrements the Tune Voltage Output level.	
<b>Clear Caldata</b>	Sets the CALDATA in memory to zero.	5 Special Functions
<b>Clear Outoflk</b>	Resets the Out of Lock flip-flop and LED indicator on the HP 11848A Interface. The Out of Lock condition will only reset if the system is within the limits required to maintain lock.	5 Special Functions
<b>Clear Overld</b>	Resets the Overload flip-flop and LED indicator on the HP 11848A Interface. The Clear Overload will only reset if it senses a non-damaging input single.	5 Special Functions



**Table 1. Softkey Descriptions (5 of 17)**

<b>Key Name</b>	<b>Description</b>	<b>Chapter</b>
<b>Cmpupd Outputs</b>	Accesses the additional formats for graphing the measurement results.	3 Graphic Functions
<b>Control</b>	Allows you to toggle between System Control (HP-IB) and Manual Control for an instrument block in the Source Control Diagram.	2 Meas. Definitions
<b>Create Dir</b>	Enables you to create a file directory for Mass Media Storage of Test Files or measurement Results Files. This softkey only appears when an existing directory cannot be found when trying to store a Test or Result File.	2 Meas. Definitions
<b>CW</b>	Refer to Carrier-Type softkey. (Not a softkey.)	5 Special Functions
<b>Dac Tests</b>	Verifies each bit for the three DACs within the HP 11848A Phase Noise Interface.	HP 3048A Calibration Manual
<b>Data Type</b>	Selects the Data Type for the Integration results. (Integrated Noise)	4 Computed Outputs
<b>Decr. HPF</b>	Decreases the HP 11848A High Pass Filter in the Noise Monitor.	5 Special Functions
<b>Decr. LPF</b>	Decreases the HP 11848A Low Pass Filter in the Noise Monitor.	5 Special Functions
<b>Define Graph</b>	Accesses the Graph Definition Display to enter the graph parameters for the Results Graph.	2 Meas. Definitions
<b>Define Msrmnt</b>	Provides access to the five Measurement Definition displays, the Test Files display, and the Parameter Summary display.	2 Meas. Definitions
<b>Delete Entry</b>	Deletes the specified entry.	4 Computed Outputs

**Table 1. Softkey Descriptions (6 of 17)**

<b>Key Name</b>	<b>Description</b>	<b>Chapter</b>
<b>Delete Instr.</b>	Allows you to delete an instrument from the System Configuration Table.	6 System Configuration
<b>Delete Point</b>	Removes a point from the Spec-Line Table in the Define Graph display.	2 Meas. Definitions
<b>Detect Const</b>	Steps through the calibration methods available on the Calibration Process display for calibrating the Phase Detector Constant.	2 Meas. Definitions
<b>DONE</b>	Returns operation to the previous display.	None
<b>Down Convert</b>	Configures a Down Converter into the Source Control Diagram. The System Control softkey is enabled for this function when the HP 11729C is selected.	2 Meas. Definitions
<b>DUT</b>	The Device Under Test configured in the Source Control Diagram. This softkey allows you to define the DUT for your measurement.	2 Meas. Definitions
<b>DUT Source</b>	Configures the signal source in the Source control Diagram for an FM Discriminator measurement.	2 Meas. Definitions
<b>Enter State</b>	Similar to Send command softkey found under 11848A Control; however, switches are now changed in the HP 11848A. (This is for a simulation only.)	5 Special Functions
<b>EFC/DCFM</b>	Configures the Tune Voltage path in the Source Control Diagram for the DCFM port or the EFC port (Electronic Frequency Control).	2 Meas. Definitions
<b>Eval Allan</b>	Solves the Allan Variance for Sigma of Tau.	4 Computed Outputs
<b>Eval. Caldata</b>	Accesses a routine that allows you to display the response of a specific calibration path.	5 Special Functions

**Table 1. Softkey Descriptions (7 of 17)**

<b>Key Name</b>	<b>Description</b>	<b>Chapter</b>
<b>Eval Intgrl</b>	Performs the computation to solve the Definite Integral for the specified entries.	4 Computed Outputs
<b>Eval Sigma</b>	Performs the computation of Sigma of Tau for the specified entries.	4 Computed Outputs
<b>FFT Segmnts</b>	Accesses the FFT Segment Table definitions.	5 Special Functions
<b>Fcntrl. Chk.</b>	Verifies HP 3048A functionality.	HP 3048A Calibration Manual
<b>Freeze Files</b>	Moves the cursor from the Measurement Results selection field to the computation results file labelling field on the 3 Source Comparison display.	4 Computed Outputs
<b>Graph Type</b>	Steps through the Graph Type Menu [ $S_{\Phi}(f)$ , $L(f)$ , $S_{\nu}(f)$ and $S_y(f)$ ] on the Define Graph display.	2 Meas. Definitions
<b>Hard Copy</b>	Outputs the current display to the printer described in the System Configuration table.	3 Graphics Functions
<b>SHIFT Hard Copy</b>	Outputs the parameter summary along with the Results Graph and initiates a form feed.	
<b>HELP</b>	Accesses operating information for the current display.	None
<b>Ignore Out of Lock</b>	Refer to Test Mode softkey. (Not a softkey.)	5 Special Functions
<b>Integr Noise</b>	Allows integration of the total noise power between two specified offset frequencies.	4 Computed Outputs
<b>Int. Adj'mnt.</b>	Accesses routines to adjust the circuits in the HP 11848A Phase Noise Interface.	HP 3048A Calibration Manual

**Table 1. Softkey Descriptions (8 of 17)**

<b>Key Name</b>	<b>Description</b>	<b>Chapter</b>
<b>Instr. Params</b>	Accesses the display for entering the operating parameters of the device being used in the measurement.	2 Meas. Definitions
<b>Known File</b>	Selects the Result File to be used as the reference for 2 Oscillator Comparison. This file must be computed from a 3 Oscillator Comparison.	4 Computed Outputs
<b>List Spurs</b>	Performs the routine to list all marked spurs within the measured data.	4 Computed Outputs
<b>Load Alt.</b>	Loads and executes the 'Alternate Test System' file from the Mass Storage Table.	6 System Configuration
<b>Load Caldata</b>	Loads the CALDATA LO or CALDATA HI from the specified Mass Storage Media specified.	5 Special Functions
<b>Load Config</b>	Loads the System Configuration Table.	6 System Configuration
<b>Load File</b>	Loads the selected Test or Result file from the mass storage media. The current file will be overwritten by the new file.	2 Meas. Definitions
<b>Load Table</b>	Loads the table of specific file locations.	6 System Configuration
<b>Lock Loop</b>	Initiates routines in the Noise Monitor Mode to close the PLL (Lock Loop). Verifies all of the system checks to ensure that the sources are phase locked.	5 Special Functions
<b>SHIFT Lock Loop</b>	Toggles the Out of Lock flip-flop. If the sources are within the specified Drift Tracking Range, the system will reinstate the locked condition.	
<b>Manage Caldata</b>	Accesses a display which allows you to display the response of a specific calibration path.	HP 3048A Calibration Manual

**Table 1. Softkey Descriptions (9 of 17)**

<b>Key Name</b>	<b>Description</b>	<b>Chapter</b>
<b>Marker</b>	Enables the Marker Function.	3 Graphics Functions
<b>Marker 1</b>	Moves marker onto raw data plot in the Evaluate Cal Data display.	HP 3048A Calibration Manual
<b>Marker 2</b>	Moves marker onto curve fitted data plot.	HP 3048A Calibration Manual
<b>Marker 3561A</b>	Reads the marker on the HP 3561A Dynamic Signal Analyzer for the Noise Monitor Mode and displays the corrected levels and offset frequency on the computer display.	5 Special Functions
<b>Marker ON/OFF</b>	Allows the addition of a Marker point on the Results Graph.	3 Graphics Functions
<b>Marker (RF Analyzer)</b>	Reads the marker on the RF Analyzer configured in the system for the Noise Monitor Mode and displays the corrected levels and offset frequency on the computer display.	5 Special Functions
<b>Mass Storage</b>	Allows you to specify the mass storage location for the HP 3048A data files.	6 System Configuration
<b>New Msrmt</b>	Initiates a new measurement using the parameters currently defined in the Measurement Definitions displays. Selecting this softkey causes the HP 3048A to complete the Measurement Calibration as defined in the Calibration Process display before making the Noise Measurement.	2 Meas. Definitions
<b>NewNse Monitor</b>	Performs a measurement calibration and then allows real-time noise measurement of single points.	5 Special Functions

**Table 1. Softkey Descriptions (10 of 17)**

<b>Key Name</b>	<b>Description</b>	<b>Chapter</b>
<b>Next Method</b>	Selects the Detector Constant ( $K_{\Phi}$ ) calibration method in the Calibration Process display.	2 Meas. Definitions
<b>Next Page</b>	Accesses the next display in the Help Text and the File Directories.	None
<b>Next Type</b>	Steps through the Measurement Types in the Type/Range definition display.	2 Meas. Definitions
<b>Noise Flat</b>	Accesses the Noise Flatness Test. This test verifies the CALDATAHI generated with an HP 3585A. If an HP 3585A is not available, the Noise Flatness Test corrects and generates modifications to CALDATAHI.	HP 3048A Calibration Manual
<b>Noise Floor</b>	Accesses the Noise Floor Test. This test verifies the HP 3048A System Noise Floor.	5 Special Functions
<b>Noise Monitor</b>	Allows real-time noise measurements of a previously calibrated noise measurement.	5 Special Functions
<b>Normal</b>	Refer to Test Mode softkey. (Not a softkey.)	5 Special Functions
<b>Normalized Bandwidths</b>	Selects the plotted BW of the graphic display. (Not a softkey.)	4 Computed Outputs
<b>Omit Spurs</b>	Performs the computation excluding all marked spurs for the specific entries.	4 Computed Outputs
<b>Option 1</b>	Generates new CALDATA for all but the external paths of the HP 11848A Phase Noise Interface.	HP 3048A Calibration Manual
<b>Option 2</b>	Generates new CALDATA for <b>all</b> of the HP 11848A Phase Noise Interface paths.	HP 3048A Calibration Manual

**Table 1. Softkey Descriptions (11 of 17)**

Key Name	Description	Chapter
<b>Other Keys</b>	Accesses the second set of graphics function keys.	3 Graphics Functions
<b>Param Summary</b>	Accesses the list of measurement setup and calibration data for the current noise graph displayed. Lists the measurement-defining parameters for the measurement results currently in memory or loaded from a Result File.	3 Graphics Functions
<b>Perf. Tests</b>	Accesses the HP 3048A System Checks that verify the performance of the HP 3048A.	HP 3048A Calibration Manual
<b>Place DUTs</b>	Configures the DUT in the Source Control Diagram for the Phase Noise Without a Phase Lock Loop measurement type.	2 Meas. Definitions
<b>Plot Data</b>  <b>SHIFT Plot Data</b>	Plots the noise data on the display without redrawing the graticule. Useful for placing multiple noise traces (loaded from the Result files) on a single graph.  Plots the noise data currently in memory to an external plotter.	3 Graphics Functions
<b>Plot ON/OFF</b>	Causes the system to display the Measurement Response of the HP 11848A circuit path as it is characterized during system calibration.	HP 3048A Calibration Manual
<b>Plotter Pens</b>	Accesses the plotter-pen specification menu from System Config Table. This menu allows you to select one of 8 colors for each of four pens.	6 System Configuration
<b>Plot w/o Spurs</b>	Plots the measured noise data currently in memory without plotting the marked spurs. To display the data without spurs, you must first select the <b>Redraw Graph</b> softkey then the <b>Plot w/o Spurs</b> softkey.	3 Graphics Functions

**Table 1. Softkey Descriptions (12 of 17)**

<b>Key Name</b>	<b>Description</b>	<b>Chapter</b>
<b>Preset</b>	Presets the HP 11848A Interface to predefined turn-on condition.	5 Special Functions
<b>Proceed w/Adj.</b>	Proceeds with the measurement using the adjusted PLL suppression when an Accuracy Specification Degradation has been detected.	8 Messages
<b>Proceed Theor.</b>	Proceeds with the measurement using the theoretical PLL suppression when an Accuracy Specification Degradation has been detected.	8 Messages
<b>Quadr Method</b>	Quadrature to be established by changing the source frequency or by manual adjustment of the delay line in the Source Control display.	2 Meas. Definitions
<b>PULSED</b>	Refer to Carrier-Type softkey. (Not a softkey.)	5 Special Functions
<b>Read Dir.</b>	Allows you to read the directory of Test or Result Files in the current mass media (disc).	2 Meas. Definitions
<b>Recal Spurs</b>	Calibrates the spurs at the end of the Spur Accuracy Performance Test.	HP 3048A Calibration Manual
<b>Redraw Graph</b>	Redraws the noise graph on the display. Used for redrawing the Results Graph, or other changes that have been made in the Define Graph display.	3 Graphics Functions
<b>SHIFT Redraw Graph</b>	Outputs graph to an external plotter.	



**Table 1. Softkey Descriptions (13 of 17)**

<b>Key Name</b>	<b>Description</b>	<b>Chapter</b>
<b>Redraw Graticl</b>	Redraws the graph without noise data. Essentially erases all plotted data from the graph.	3 Graphics Function
<b>SHIFT Redraw Graticl</b>	Outputs graph to an external plotter.	
<b>Ref. Source</b>	Allows you to specify a reference source in the Source Control Diagram. Accesses each RF Source entered in the System Configuration Table and the HP 11848A's internal sources.	2 Meas. Definitions
<b>Remove Line</b>	Erases the slope line that the cursor is positioned on.	3 Graphics Functions
<b>Repeat Msrmnt</b>	Initiates a measurement without performing a measurement calibration. This should only be used for measuring the same device or a similar device with the same power level ( $\pm 0.5$ dB) at the same frequency.	2 Meas. Definitions
<b>Results Files</b>	Accesses the Results File Directory. You may load or store Results Files from this menu.	3 Graphics Functions
<b>RF Segmnts</b>	Accesses the RF Segment Tables. This special function enables you to modify the Segment Tables to enhance your measurement.	5 Special Functions
<b>Run Test</b>	Initiates execution of the selected functional test.	HP 3048A Calibration Manual
<b>Select Detect.</b>	Allows you to select one of three available phase detector input ports of the HP 11848A from the Define Graph display.	2 Meas. Definitions
<b>Select Path</b>	Allows selection of the signal path within the HP 11848A to be characterized by the selected test.	HP 3048A Calibration Manual

**Table 1. Softkey Descriptions (14 of 17)**

<b>Key Name</b>	<b>Description</b>	<b>Chapter</b>
<b>Select Test</b>	Allows selection of individual tests from the Functional Test display.	HP 3048A Calibration Manual
<b>Send Command</b>	Outputs the conditions displayed on the 11848 Control display to the HP 11848A interface.	5 Special Functions
<b>Set Clock</b>	Sets the computer's real time clock.	6 System Configuration
<b>Set Line</b>	Sets the slope line currently active on the graph.	3 Graphics Functions
<b>Sigma vs. Tau</b>	Allows computation of Sigma for the specified N, T, Tau, and Stop frequency.	4 Computed Outputs
<b>Slope Lines</b>	Allows you to place slope lines on the Results Graph.	3 Graphics Functions
<b>Sngl Path</b>	Selects the signal path for the Functional Check.	HP 3048A Calibration Manual
<b>Solve A,B,C</b>	Initiates the Three Oscillator Comparison computation.	4 Computed Outputs
<b>Solve for B</b>	Initiates the Two Oscillator Comparison computation.	4 Computed Outputs
<b>Source</b>	Configures the source in the Source Control Diagram for Phase Noise Without a Phase Lock Loop measurement.	2 Meas. Definitions
<b>Source Control</b>	Accesses the Source Control Diagram for defining the measurement set up and HP-IB control requirements.	2 Meas. Definitions
<b>Span</b>	Increments the spans defined in the FFT and RF Segment Tables for the Noise Monitor Mode.	5 Special Functions

**Table 1. Softkey Descriptions (15 of 17)**

<b>Key Name</b>	<b>Description</b>	<b>Chapter</b>
<b>Spcl. Funct'n</b>	<p>Recommended for advanced users only. Accesses the HP 3048A's advanced operating functions.</p> <ul style="list-style-type: none"> <li>● Modify the measurement segment definitions.</li> <li>● Execute system performance verification and calibration.</li> <li>● Select the test mode.</li> <li>● Modify the measurement process to support measurement of pulsed carriers.</li> <li>● Interactively control the internal configuration of the HP 11848A Interface.</li> <li>● Manipulate the system CAL DATA.</li> <li>● Noise Monitor.</li> </ul>	5 Special Functions
<b>Spec Lines</b>	Allows definition of specification lines in the Define Graph display.	2 Meas. Definitions
<b>Spur Accy.</b>	Verifies Spur Accuracy. This performance test verifies the HP 3048A measurement accuracy to 550 kHz.	HP 3048A Calibration Manual
<b>Spur List</b>	Generates a list of all the spurs marked within the measurement (up to 100 entries). This list can be output to a printer by selecting <input type="button" value="Hard Copy"/> .	3 Graphics Functions
<b>Store Caldata</b>	Stores the CALDATA LO or CALDATA HI from memory to the mass storage media specified in the Mass Storage Media File (System Configuration).	5 Special Functions
<b>Store Config</b>	Allows you to store the System Configuration Table to the mass storage media specified in the mass storage table.	6 System Configuration
<b>Store File</b>	Stores a Test File or Result File.	2 Meas. Definitions
<b>Store Table</b>	Stores the currently configured file directory.	6 System Configuration

**Table 1. Softkey Descriptions (16 of 17)**

<b>Key Name</b>	<b>Description</b>	<b>Chapter</b>
<b>Suppr. Plot</b>	Accesses the PLL Suppression Plot. This softkey only appears when an Accuracy Specification Degradation is detected. The PLL Suppression Plot is automatically displayed when the Troubleshoot Mode has been selected.	5 System Configuration
<b>System Clock</b>	Provides access to the systems real time clock.	6 System Configuration
<b>System Config</b>	Accesses the System Configuration Table. All equipment to be controlled over the HP-IB interface must be listed in this table.	6 System Configuration
<b>System Preset</b>	Allows you to reset the system hardware to its predefined turn-on state. System preset loads the Default data files and configures the HP 3048A to make its demonstration measurement when the New Measurement softkey is pressed.	None
<b>Take Sweep</b>	Initiates measurement of the span selected in the Noise Monitor display.	5 Special Functions
<b>Test All</b>	Selects all of the available tests.	HP 3048A Calibration Manual
<b>Test Files</b>	Accesses the Test File Directory. You may load or store Test Files from this menu.	2 Meas. Definitions
<b>Test Mode</b>	Allows selection of the Normal, Trouble Shoot, or Ignore Out-of-lock mode.	5 Special Functions
Normal	Default Test Mode; PLL suppression is not plotted unless an accuracy specification degradation of >1dB is measured.	
Trouble Shoot	Enables plotting of the PLL suppression during its characterization and provides access to 11848A Control at the Connect Diagram and other displays.	
<b>(cont'd)</b>		

**Table 1. Softkey Descriptions (17 of 17)**

<b>Key Name</b>	<b>Description</b>	<b>Chapter</b>
<b>Test Mode (cont'd)</b> Ignore Out-of-lock	Bypasses all automatic system checks for phase lock and enables plotting of the PLL suppression. This mode is recommended only for very noisy devices and should be selected by advanced users only. A New Msrmnt performed in Ignore Out-of-lock Mode will make a single attempt to close the phase lock loop upon completion of measurement calibration.	
<b>Time Base</b>	Allows you to define the Time Base connection for sources in the Source Control Diagram.	2 Meas. Definitions
<b>Toggle LNA</b>	Allows LNA to be switched In or Out when a pulsed carrier type is selected.	5 Special Functions
<b>Trouble Shoot</b>	Refer to Test Mode softkey	5 Special Functions
<b>Tuning Const</b>	Steps through the calibration methods available on the Calibration Process display for calibrating the VCO Tuning Constant.	2 Meas. Definitions
<b>Tune Voltage</b>	Allows you to define the Tune Voltage path for the VCO source in the Source Control diagram.	2 Meas. Definitions
<b>Type/Range</b>	Accesses the Measurement Type and Offset Frequency Range for the display for defining measurement.	2 Meas. Definitions
<b>Update Dir.</b>	Allows you to change the name of a file within the Test or Result File directory.	2 Meas. Definitions
<b>Verify Suppr</b>	Verifies suppression of the phase lock loop. Verification is recommended.	2 Meas. Definitions
<b>View VNOMS</b>	Displays the current VNOMS values in memory.	HP 3048A Calibration Manual

# General Information

---

# 1

## Introduction

The HP 3048A Phase Noise Measurement Reference Manual is designed to aid you in understanding and performing the HP 3048A measurement techniques and its advanced features. Within this chapter is the general information that describes the HP 3048A and its support services.

<b>HP 3048A Description</b> .....	pg. 1-2
<b>Documentation Updating</b> .....	pg. 1-4
<b>Software Updating</b> .....	pg. 1-5
<b>Guide to System Flexibility</b> .....	pg. 1-7
<b>HP 3048A System and Option Specifications</b> .....	pg. 1-11

# HP 3048A Description

## What is the HP 3048A?

The HP 3048A provides you a standard process for measuring phase noise. It allows you to measure sources of many types with a flexible system configuration.

The HP 3048A Phase Noise Measurement System includes:

- **The HP 11848A Phase Noise Interface**, an interface box specifically designed for high performance phase noise measurements. The HP 11848A supports several measurement techniques for phase noise and AM noise measurement. Built in to the interface are phase detectors, amplifiers, filters, and switches necessary to measure phase noise over a frequency range of 5 MHz to 18 GHz. An input for an external phase detector outside the above mentioned frequency range is also provided. Internal sources are provided to allow the system to functionally check all of its signal handling circuits insuring proper operation prior to making a measurement.
- **The HP 3561A Dynamic Signal Analyzer**, a Fast Fourier Transform analyzer of a wide frequency range (125  $\mu$ Hz to 100 kHz). The HP 3561A has built-in data averaging capabilities, large dynamic range, and fast measurement speed which make it ideal for quantifying demodulated phase noise (noise voltages).
- **Measurement software**, a program that includes all drivers necessary to run both standard and optional instruments of the HP 3048A system.
- **Operator's Training**, an operator's training course that explains all of the operating modes and measurement techniques of the HP 3048A, when each technique is appropriate, and how to analyze the measured data.

## What is the HP 3048A Used For ?

The HP 3048A is designed to reduce the difficulty of making accurate phase noise measurements. The HP 3048A allows you to make phase noise measurements using a phase detector in a phase lock loop configuration, a phase detector without a phase lock loop, or with an FM discriminator.

Each method allows the measurement results to be plotted as phase noise ( $\mathcal{L}(f)$  or  $S_{\Phi}(f)$ ), or frequency noise ( $S_y(f)$  or  $S_{\nu}(f)$ ) over an offset range of 1 mHz to 100 kHz (or to 40 MHz with a supported RF Analyzer).

Using an external crystal detector, the HP 3048A system can automatically quantify the level of AM noise that could affect a phase noise measurement.

The HP 3048A allows you to measure and plot the results of Noise Voltage measurements.

A real-time measurement mode (Noise Monitor) is available for monitoring single frequency points, or changes in the level of phase noise and discrete spurs as changes are made to the device-under-test.

The system also allows you to plot measured data (Computed Outputs) as:

- Integrated Noise,
- Sigma vs Tau (Allan Variance),
- Various Normalized Bandwidths,
- 2 or 3 Oscillator Comparisons,
- Spur Listings.



## Documentation Updating

A "MANUAL UPDATES" packet is shipped with the manual when changes to the manual are necessary to provide the most current information about the product available at the time of shipment. These packets consist of replacement and addition pages which should be incorporated into the manual to bring it up to date.

Hewlett-Packard offers a Documentation Update Service that will provide you with further updates as they become available. If you plan to operate or service HP 3048A's with different serial prefixes, we strongly recommend that you join this service immediately to ensure that this manual is kept current. For more information, refer to the Documentation Update Service reply card included in this manual.

## **Software Updating**

Software is a significant part of the HP 3048A Phase Noise System. Hewlett-Packard offers two levels of software support services for the HP 3048A, the Software Material Subscription, and the Software Notification Service.

### **Software Material Subscription**

Software Materials Subscription (SMS) ensures that your software is never out-of-date. SMS automatically provides you with update changes to your HP software as they are released.

When you purchase an SMS contract, you will receive the following materials:

- New Software Releases
- Software Status Bulletins
- Software Release Bulletins
- Documentation Updates

### **Software Notification Service**

Software Notification Service (SNS) keeps you up-to-date with the latest changes to your software and informs you when new software releases will be available.

When you purchase an SNS contract, you will receive the following materials:

- Software Status Bulletin
- Software Release Bulletin

## **New Software Releases**

With SMS you will automatically receive all software releases for the HP 3048A as they become available. These releases may provide increased software performance and capability, or the resolution of specific anomalies. You will also receive all pertinent information necessary to ensure a smooth transition to the new software revision.

## **Software Status Bulletin**

With either SMS or SNS you will receive the Software Status Bulletin (SSB). The Software Status Bulletin (SSB) contains timely information on reported discrepancies in HP software and documentation, and temporary correction or workaround information.

## **Software Release Bulletin**

The Software Release Bulletin (SRB) is provided with both the SMS and the SNS. When a new software release is made for the HP 3048A, all problems that were corrected in that release are reported in the Software Release Bulletin. The problem is then removed from the SSB.

## **Documentation Updates**

You will receive Documentation Updates automatically when you purchase an SMS contract.

## Guide to System Flexibility

The HP 3048A can be configured many different ways to optimize its operation for specific applications. All configurations of this system must include the HP 3048A's basic components and a desktop computer to be operational. The following guide will help you match your applications to the optimum system configuration.

### HP 3048A Reference Source Options

- **Option 001 adds the HP 8662A Opt. 003 Synthesized Signal Generator** as a 10 kHz to 1280 MHz reference source.
- **Option 002 adds the HP 8663A Opt. 003 Synthesized Signal Generator** as a 10 kHz to 2560 MHz reference source
- **Option 003 adds the HP 11729C Carrier Noise Test Set** as a 5 MHz to 18 GHz down converter to the system (requires an HP 8662A Opt. 003 or HP 8663A Opt. 003 as its reference source).
- **Option 004 adds the HP 11729C Opt. 130 Carrier Noise Test Set** as a 5 MHz to 18 GHz down converter to the system (requires an HP 8662A Opt. 003 or HP 8663A Opt. 003 as its reference source).
- **Option 005 adds the HP 8642A Opt. 001 Synthesized Signal Generator** as 100 kHz to 1057 MHz reference source.
- **Option 006 adds the HP 8642B Opt. 001 Synthesized Signal Generator** as 100 kHz to 2115 MHz reference source.

## HP 3048A Spectrum Analyzer Options

- **Option 101 adds the HP 3585B Spectrum Analyzer** to extend the system's offset measurement range from 100 kHz to 40 MHz. The HP 3585A/B is required to generate new CALDATAHI. CALDATAHI can be verified and corrected by any supported RF Analyzer by performing the Noise Flatness Performance test.
- **Option 110 deletes HP 3561A Dynamic Signal Analyzer** from the system for replacement by the user. (The HP 3048A will not operate without the HP 3561A. Option 110 allows a customer-owned HP 3561A to be integrated into the HP 3048A system. The HP 3561A must meet its specifications for the HP 3048A system specifications to be warranted.)

## HP 3048A System Options

- **Option 201 adds the 1.6 to 18 GHz Phase Detector to the HP 11848A Phase Noise Interface** for microwave phase noise measurements without a down converter.
- **Option 202 adds the System Rack** with built-in signal cabling, fan and power module (includes racking hardware and installation of the HP 11848A, HP 3561A, and any HP 3048A instrument options).
- **Option 910 adds an extra HP 3048A Manual Set** to the system. This includes the following manuals: HP 11848A Service Manual (11848-90004), HP 3048A Operating Manual (03048-90001), HP 3048A Calibration Manual (03048-90015), and HP 3048A Reference Manual (03048-90002).

## Desktop Computers

Computers used with the HP 3048A system must have a BASIC 5.0 Operating System, and a minimum of 3 Mbytes of RAM to operate the HP 3048A software.

- **HP 98580B, Options ABA and 008, Series 300 Measurement Automation System** includes 1 Mbyte of RAM. An HP 46083A HP-HIL Knob should also be ordered with this computer to control the HP 3048A graphics marker. Alternatively, an HP 98203C Keyboard with a built-in knob may be ordered. Order Option 05A to delete the standard keyboard, and then order the HP 98203C Keyboard separately. (Order HP 98257A, 1 Mbyte RAM Cards to add memory.)
- **HP 9836S, Option 001, Series 200 Desktop Computer Option 001** provides 1 Mbyte of RAM. A 3<sup>1</sup>/<sub>2</sub>-inch external disc drive such as the HP 9122D or the HP 9153A Winchester disc drive is required with the HP 9836S Series 200 Desktop Computer. (Order HP 98257A, 1 Mbyte RAM Cards to add memory.)

## Computer Accessories

- **HP 98203C Keyboard** with built-in knob.
- **HP46083A HP-HIL Knob** needed by the HP 98580A Desktop Computer to control the graphics marker of the HP 3048A (not needed if the HP 98203C Keyboard is ordered).
- **HP 98257A 1 Mbyte RAM Card** used with the HP 98580A and HP 9836A Desktop Computers.
- **HP 10833B 2-meter HP-IB Cable** one required to connect each computer, printer, spectrum analyzer, or disc drive to the HP 3048A system.

## Disc Drives

- **HP 9122D Dual Disc Drive** for 3<sup>1</sup>/<sub>2</sub>-inch flexible discs.
- **HP 9153A 10 Mbyte Winchester Disc Drive** with a built-in 3<sup>1</sup>/<sub>2</sub>-inch flexible disc drive.

## Spectrum Analyzers

The addition of any of the following Spectrum Analyzers extends the offset range to 40 MHz.

- **HP 3585A/B 20 kHz to 40 MHz Spectrum Analyzer** provides Tracking Generator output needed to generate CALDATAHI for calibration of the HP 3048A from 100 kHz to 40 MHz. (All supported spectrum analyzers can be used to verify or modify CALDATAHI.)
- **HP 8562A 1 kHz to 22 GHz Spectrum Analyzer**
- **HP 8568A/B 100 Hz to 1500 MHz Spectrum Analyzer**
- **HP 8567A 1 kHz to 1500 MHz Spectrum Analyzer**
- **HP 8566A/B 100 Hz to 22 GHz Spectrum Analyzer**
- **HP 71100A 100 Hz to 2.9 GHz Spectrum Analyzer**
- **HP 71200A 50 kHz to 22 GHz Spectrum Analyzer**

## Printers/Plotters

- **HP 2225A Thinkjet Printer** for plotting graphs and documenting tests.

## **System and Option Specifications**

The System specifications and Option specifications are listed in Table 1-1 and Table 1-2 respectively. Specifications describe the instrument's warranted performance. Supplemental characteristics are intended to provide information useful in applying the instrument by giving typical, but not warranted performance parameters. These supplemental characteristics are denoted as "typical," "nominal," or "approximate."

## **National Bureau of Standards Traceability**

Measurement of phase noise is a ratio measurement where both the numerator (the noise power) and the denominator (the carrier's power) of the ratio are measured by the same system spectrum analyzer(s). The accuracy of this relative measurement depends on the amplitude linearity of the spectrum analyzer. (A precision attenuator is used, to verify the linearity specification of the spectrum analyzer.) The amplitude linearity calibration of the spectrum analyzer is be traceable to the National Bureau of Standards (NBS) if the precision attenuator and other instruments used to perform the calibration are traceable to NBS.



Table 1-1. HP 3048A System Specifications (1 of 4)

# HP 3048A System Specifications

## PHASE DETECTOR PORTS

### Frequency

**Range:** 5 MHz to 1.6 GHz (low-frequency inputs)

**Additional Range with Option 201:** 1.2 to 18 GHz (high-frequency inputs) (The frequency range can be extended with a customer-supplied phase detector or frequency discriminator.)

### Amplitude

	Low-Frequency Inputs		High-Frequency Inputs	
	L in	R in	L in	R in
<b>Maximum Signal (dBm)</b>	+23	+23	+10	+5
<b>Minimum Signal (dBm)</b>	+15	+0	+7	+0

### Offset Frequency Range

0.01 Hz to 40 MHz for carriers from 95 MHz to 18 GHz

0.01 Hz to 2 MHz for carriers from 5 MHz to 95 MHz

(Assumes addition of 40 MHz spectrum analyzer to the system, otherwise offset range limited to 100 kHz.)

**Accuracy** (measurement of all noise and spurious present at the two inputs to the phase detector and system contribution):

±2 dB for 0.01 Hz to 1 MHz offsets

±4 dB for 1 MHz to 40 MHz offsets

In order for the HP 3048A to meet its accuracy specifications, the following qualifications must be met:

- Source return loss >9.5 dB (<2 : 1 SWR)
- Source harmonic distortion <-20 dB (or a square wave)
- Nonharmonic spurious, except for phase modulation close to the carrier, ≤-26 dBc

**Table 1-1. HP 3048A System Specifications (2 of 4)**

**System Phase Noise and Spurious Responses**

(Does not include phase noise and spurious signals from a reference source.)

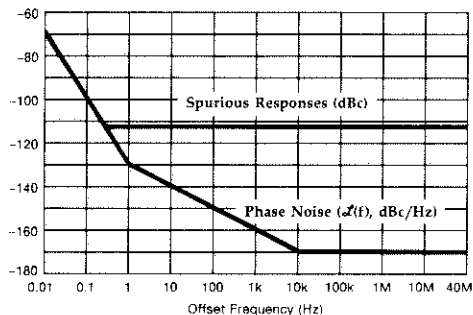

**System Noise and Spurious Response Increase with Input Level Decrease**

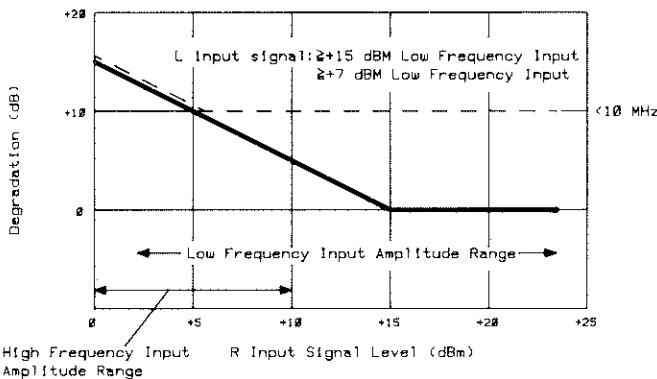

To determine system noise and spurious response levels, find the dB degradation at the signal input level from the lower graph and add to the curves of the upper graph. For example, if a +15 dBm signal is applied to the Low Frequency L Input and a +5 dBm signal to the R Input, the degradation is +10 dB. Therefore, the specified maximum spurious signal level increases from -112 to -102 dBc at all offset frequencies and the system's maximum noise level at >10 kHz offset frequencies increases from -170 to -160 dBc/Hz.

Table 1-1. HP 3048A System Specifications (3 of 4)

## NOISE INPUT PORT

(For use with external phase detector or frequency discriminator)

**Frequency:** 0.01 Hz to 40 MHz

**Amplitude:** 1 Volt peak maximum

**Typical Input Impedance:** 50 $\Omega$ ; return loss >9.5 dB (<2:1 SWR)

**Accuracy:** External phase detector or frequency discriminator measurements calibrated with  $\pm 1$  dB accurate signals.

$\pm 2$  dB for 0.01 Hz to 1 MHz offsets

$\pm 4$  dB for 1 MHz to 40 MHz offsets

### System Noise and Spurious Responses

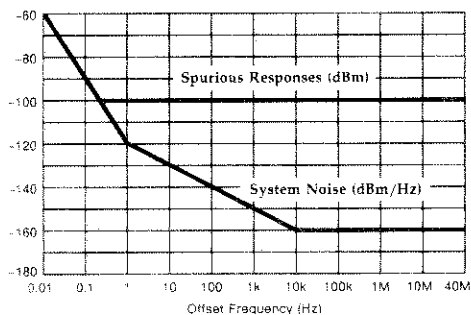

## TUNING VOLTAGE OUTPUT

**Voltage Range:**  $\pm 10$  volts

**Current:**  $\pm 20$  mA maximum

**Output Impedance:** 50 $\Omega$  nominal

## SOURCE OUTPUT TYPICAL PERFORMANCE

### 10 MHz Source A

**Amplitude:** +15 dBm

**Tuning:**  $\pm 100$  Hz

### 10 MHz Source B

**Amplitude:** +6 dBm

**Tuning:**  $\pm 1$  kHz

### 350-500 MHz

**Amplitude:** +17 dBm

### 400 MHz

**Amplitude:** -5 dBm

**Tuning:** Fixed Frequency

**Table 1-1. HP 3048A System Specifications (4 of 4)**

**Typical Noise and Spur Levels**

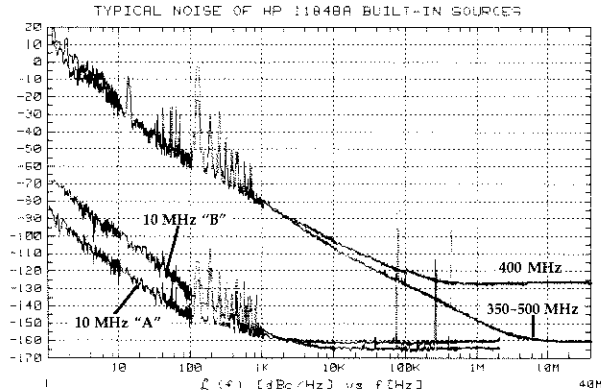

**Power Requirements:** Between 190 and 900 VA depending on options included; 48 to 66 Hz; 100V, 110V, 220V, 240V (+5%, -10% of line voltage)

**Operating Temperature Range:** +0°C to +55°C

**EMI:** Satisfies level B of VDE specification 0871

**General Considerations:** The HP 3048A has low susceptibility to RFI and mechanical vibration. Care must be exercised however in making measurements in high RFI or mechanical vibration environments as spurious signals may be induced in the system.

**Warm-up time:** The HP 3048A will meet specification 20 minutes after turn-on.

**Size:** The HP 3048A system is composed of individual instruments that vary in size. Each instrument's individual specifications should be consulted for its dimensions. The HP 11848A Phase Noise Interface is approximately 146 H × 425 W × 593 D cm (5.7 × 16.8 × 23.3 inches).

**Weight:** Net weight varies from 31 to 275 kg (68 to 603 lbs) depending on the options ordered. Shipping weight varies from 42 to 347 kg (93 to 758 lbs).

Table 1-2. HP 3048A System Option Specifications (1 of 9)

## HP 3048A Option Specifications

The HP 3048A can be ordered with any of several optional signal generators as a reference source for phase noise measurements. The following specifications address system operation with these signal generators. The data that follows is in addition to that given previously under the heading of HP 3048A System Specifications. Refer to the data sheet for each signal generator for more complete information on each model.

### **OPTIONS 001 OR 002: ADDING THE HP 8662A OR 8663A SIGNAL GENERATOR**

The following data applies only if either the HP 8662A Opt. 003 or 8663A Opt. 003 is used as the reference source to demodulate the test signal.

#### **Frequency**

**Range:** 100 kHz to 1280 MHz (to 2560 MHz with HP 8663A).<sup>1</sup>

**Resolution:** 0.1 Hz, 0.2 Hz: 640 to 1280 MHz, 0.4 Hz above 1280 MHz.

**Accuracy and Stability** (internal 10 MHz quartz oscillator):

Aging rate  $< 5 \times 10^{-10}$ /day after 10-day warm-up (typically 24 hrs in normal operating environment).

**EFC:** Provides a drift tracking range of  $\pm 10^{-8}$  with no degradation of phase noise or spurious.

<sup>1</sup>Measurements  $< 5$  MHz require external phase detector.

Table 1-2. HP 3048A System Option Specifications (2 of 9)

**Spectral Purity<sup>2</sup>**  
**Absolute Phase Noise**

		Offset from Carrier (Hz)						
		1	10	100	1k	10k	100k	1M
0.1 to 120 MHz	Typ.	-78	-108	-126	-132	-138	-139	-145
	Spec.	-68	-98	-116	-126	-132	-133	
120 to 160 MHz	Typ.	-76	-106	-125	-135	-148	-148	-150
	Spec.	-66	-96	-115	-129	-142	-142	
160 to 320 MHz	Typ.	-70	-100	-119	-130	-142	-142	-148
	Spec.	-60	-90	-109	-124	-136	-138	
320 to 640 MHz	Typ.	-64	-94	-114	-125	-136	-136	-145
	Spec.	-54	-84	-103	-118	-131	-132	
640 to 1280 MHz	Typ.	-58	-88	-108	-119	-130	-130	-140
	Spec.	-48	-78	-97	-112	-124	-126	
1280 to 2560 MHz <sup>+</sup>	Typ.	-52	-82	-102	-113	-124	-124	-134
	Spec.	-42	-72	-92	-106	-118	-120	

\* HP 8663A Option 003 only.

**Typical HP 8662A/8663A Phase Noise**  
 (With DCFM, 10 MHz "A" and EFC tuning)

The absolute phase noise of the HP 8662A and HP 8663A is dependent on the tuning mode used to control the PLL.

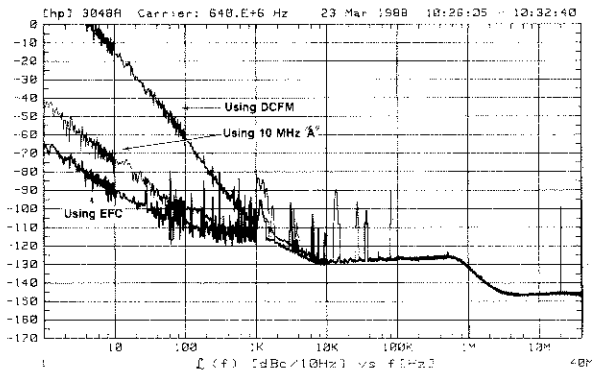

<sup>2</sup>Specified only with FM off.

**Table 1-2. HP 3048A System Option Specifications (3 of 9)**

**Spurious Signals**

	Frequency Range (MHz)					
	0.1 to 120	120 to 160	160 to 320	320 to 640	640 to 1280	1280 to 2560
Spurious nonharmonically related <sup>1</sup>	-90 dBc	-100 dBc	-96 dBc	-90 dBc	-84 dBc	-78 dBc
Subharmonically related (1/2, 3f/2, etc.)	none	none	none	none	-70 <sup>2</sup> dBc	-40 dBc
Power line (60 Hz) related to microphonically generated (within 300 Hz) <sup>3</sup>	-90 dBc	-85 dBc	-80 dBc	-75 dBc	-70 dBc	-65 dBc
Harmonics	≤30 dBc					

<sup>1</sup> In the remote mode it is possible to have microprocessor clock-related spurious signals spaced 3 MHz apart at an absolute level of typically less than -145 dBm.  
<sup>2</sup> 3/2 spurs not specified for HP 8662A carrier frequencies above 850 MHz.  
<sup>3</sup> At a 50 Hz line frequency, powerline or microphonically related spurious signals may be up to 3 dB higher and appear at offsets as high as 1 kHz from the carrier.

**Amplitude**

**Typical Maximum Output Level:** +16 dBm

**Modulation**

**Modulation Types:** FM, AM (Pulse with the HP 8663A)

**FM Deviation**

Center Frequency (MHz)	Maximum Peak Deviation dc FM (kHz)
0.1 – 120	100
120 – 160	25
160 – 320	50
320 – 640	100
640 – 1280	200
1280 – 2560*	400

\*HP 8663A Option 003 only

**Indicated FM Accuracy:** ±8% (7% for HP 8663A) of reading plus 10 Hz (50 Hz to 20 kHz rates).

**Input Impedance:** HP 8662A: 1kΩ nominal, HP 8663A: 600Ω.

**Maximum Input Level:** 1V peak for specified accuracy.

**Temperature Range:** +15° to 35°C.

**Table 1-2. HP 3048A System Option Specifications (4 of 9)**

### **OPTIONS 003 OR 004: ADDING THE HP 11729C OR 11729C OPT 130 CARRIER NOISE TEST SET**

The following data is applicable to using the HP 11729C to downconvert the test signal to an IF of between 5 MHz and 1280 MHz for subsequent demodulation using the Low Frequency phase detector of the HP 3048A system. The HP 8662A Opt. 003 or 8663A Opt. 003 Signal Generators provide a 640 MHz reference signal for this downconversion process. These signal generators also provide a signal of between 5 MHz to 1280 MHz to demodulate the downconverted IF noise. The specifications that follow assume this measurement set-up is used.

#### **Input Requirements**

##### **Frequency**

**Measurement Frequency Range:** 5 MHz to 18 GHz in 8 bands, excluding  $\pm 5$  MHz around band center frequencies.

**Band Center Frequencies:** 1.92 GHz, 4.48 GHz, 7.04 GHz, 9.60 GHz, 12.16 GHz, 14.72 GHz, 17.28 GHz.

##### **Amplitude**

**For carrier frequencies <1.28 GHz:** -5 dBm minimum to +23 dBm maximum.

**For carrier frequencies >1.28 GHz:** +7 dBm minimum to +20 dBm maximum.

##### **Measurement Specifications**

###### **Offset Frequency Range**

**For carriers between 5 and 95 MHz from band centers:** 0.01 Hz to 2 MHz.

**For carriers >95 MHz from band center:** 0.01 Hz to 40 MHz.

(Assumes addition of 40 MHz spectrum analyzer to the system, otherwise offset frequency range limited to 100 kHz.)

###### **System Noise Floor<sup>3</sup>**

Absolute System Noise Floor (dBc/Hz), when used with the HP 11729C and HP 8662A Option 003 or HP 8663A Option 003 as the reference source, phase locking via the signal generator's EFC.

<sup>3</sup>Specified only with FM off.



**Table 1-2. HP 3048A System Option Specifications (5 of 9)**

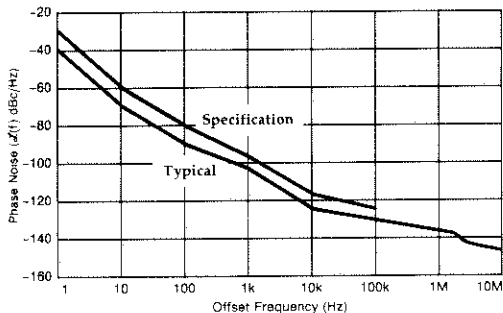

		Offset from Carrier (Hz)						
		1	10	100	1k	10k	100k	1M
0.1 to 1280 MHz		See HP 3048A Option 001 or 002, Absolute Phase Noise table.						
1280 to 3200 MHz	Typ.	-53	-83	-103	-115	-129	-130	-140
	Spec.	-43	-73	-93	-108	-124	-126	
3.2 to 5.76 GHz	Typ.	-47	-77	-97	-109	-127	-130	-138
	Spec.	-37	-67	-87	-104	-123	-126	
5.76 to 8.32 GHz	Typ.	-43	-73	-93	-105	-125	-129	-135
	Spec.	-33	-63	-83	-100	-121	-125	
8.32 to 10.88 GHz	Typ.	-40	-70	-90	-102	-123	-129	-134
	Spec.	-30	-60	-80	-97	-119	-125	
10.88 to 13.44 GHz	Typ.	-38	-68	-88	-100	-122	-128	-132
	Spec.	-28	-58	-78	-95	-118	-125	
13.44 to 16.0 GHz	Typ.	-37	-67	-87	-99	-121	-127	-131
	Spec.	-27	-57	-77	-94	-116	-124	
16.0 to 18.0 GHz	Typ.	-35	-65	-85	-97	-119	-127	-129
	Spec.	-25	-55	-75	-92	-115	-123	

**Table 1-2. HP 3048A System Option Specifications (6 of 9)**

**System Spurious**

System spurious signals in the HP 3048A Options 003 or 004 arise in three ways. First, from the detection and baseband signal processing,  $<-104$  dBc for offsets greater than 0.2 Hz from the carrier. Second, any line-related or other spurious signals on the HP 8662A or 8663A outputs are translated to the noise spectrum output. Third, the downconversion process gives rise to system spurious signals whose frequency and level are determined by the relation between the test signal frequency and the band center frequency. The presence of system spurious signals does not affect the typical measurement of random noise.

**AM Noise Detection**

The HP 3048A can be used for AM noise measurements using either an external AM detector or the AM detector built-in to the HP 11729C Option 130 (ordered as Option 004 of the HP 3048A). AM measurements with the HP 11729C Option 130 can be made with a typical sensitivity of  $-165$  dBc/Hz at a 1 MHz offset.

**OPTION 005 OR 006: ADDING THE HP 8642A OPT. 001 OR 8642B OPT. 001 SIGNAL GENERATOR**

The following data applies only if the HP 8642A Opt. 001 or 8642B Opt. 001 is used as the reference source to demodulate the test signal.

**Frequency**

**Range:** 100 kHz to 1057.5 MHz (to 2115 MHz with the HP 8642B)<sup>4</sup>

**Opt. 001 Stability:**  $<10^{-9}$ /day aging after 8 days warm-up.

<sup>4</sup>Measurements  $<5$  MHz require external phase detector.

Table 1-2. HP 3048A System Option Specifications (7 of 9)

**Spectral Purity**

**Absolute Phase Noise<sup>5</sup>**

Carrier Frequency Band	SSB Phase Noise 20 kHz Offset dBc/Hz	SSB Phase Noise Floor 200 kHz Offset dBc/Hz
1057.5 - 2115*	-125	-134
528.7 - 1057.5	-134	-144
264.3 - 528.7	-137	-144
132.1 - 264.3	-141	-144
66.0 - 132.1	-144	-145
33.0 - 66.0	-145	-145
16.5 - 33.0	-146	-147
8.2 - 16.5	-147	-148
4.1 - 8.2	-148	-149
0.1 - 4.1	-137	-138
0.1 - 132.1 HET	-125	-137

\* HP 8642B only.

**Spurious**

Type of Spurious	0.1 to 1052.5 MHz	1057.5 to 2115 MHz <sup>1</sup>
<b>Harmonics</b>		
Output Level $\leq +10$ dBm	-30 dBc	-25 dBc
Output Level $\leq +16$ dBm	-20 dBc	-20 dBc
<b>Subharmonics</b>	none	-45 dBc
<b>Nonharmonics, &gt; 10 kHz from the carrier</b>	-100 dBc <sup>2</sup>	-94 dBc

<sup>1</sup> HP 8642B only.      <sup>2</sup> Not specified in HET band.

**Typical SSB AM Noise Floor at 200 kHz Offset, +16 dBm**

**Output Power:**

- <-157 dBc/Hz, 4.13 to 1057 MHz
- <-150 dBc/Hz, 1057 to 2115 MHz

<sup>5</sup>Specified only for dc FM <200 kHz.

**Table 1-2. HP 3048A System Option Specifications (8 of 9)**

**Amplitude**

**Maximum Output Level:** >16 dBm.

**Modulation**

**Modulation Types:** FM, AM, Phase, Pulse

**FM Deviation**

Carrier Frequency Band	Maximum Deviation dc Coupled
1057.5 - 2115 <sup>1</sup>	3 MHz
528.7 - 1057.5	1.5 MHz
264.3 - 528.7	750 kHz
132.1 - 264.3	375 kHz
66.0 - 132.1 <sup>2</sup>	187 kHz
33.0 - 66.0 <sup>2</sup>	93.8 kHz
16.5 - 33.0 <sup>2</sup>	46.9 kHz
8.2 - 16.5 <sup>2</sup>	23.4 kHz
4.1 - 8.2 <sup>2</sup>	11.7 kHz
0.1 - 4.1 <sup>2</sup>	93.8 kHz
0.1 - 132.1 HET	1.5 MHz

<sup>1</sup> HP 8642B only.

<sup>2</sup> Maximum deviation may be increased up to that shown for the HET band (0.1 MHz to 132.1875 MHz carrier frequency) by selecting deviation larger than the value shown here. HET band can also be selected with the special function.

**FM Accuracy, Rates <100 kHz:** ±(5% of setting + 10 Hz).

**Typical Input Impedance:** 600Ω nominal.

**Maximum Input Level:** 1V peak.

**OPTION 101: ADDING THE HP 3585A SPECTRUM ANALYZER**

This option extends the offset measurement range of the HP 3048A from 100 kHz to 40 MHz. All of the HP 3048A specifications dependent on an offset measurement range from 100 kHz to 40 MHz are valid with this option.

**OPTION 110: DELETING THE HP 3561A DYNAMIC SIGNAL ANALYZER**

This option is provided to allow HP 3561A's already owned by the purchaser of the HP 3048A to be used in the system. A user-supplied HP 3561A included in the HP 3048A system must be operating properly and meet its specifications for the HP 3048A specifications to be valid. Note that the HP 3048A will not operate without an HP 3561A included in the system.

**Table 1-2. HP 3048A System Option Specifications (9 of 9)**

### **COMPATIBLE SPECTRUM ANALYZERS**

The HP 3048A is designed to use several Hewlett-Packard spectrum analyzers to extend the offset range from 100 kHz to 40 MHz. Those spectrum analyzers include the HP 3585A (orderable as Option 101 to the HP 3048A), the HP 8562A/B, 8566A/B, 8567A, 8568A/B, 71100A, and 71200A. Automatic control of each of these spectrum analyzers is provided. The HP 3048A specifications apply fully when these compatible spectrum analyzers are included in the system as long as the spectrum analyzer is operating properly and meets its performance specifications.

### **OPTION 201: ADD HIGH FREQUENCY PHASE DETECTOR**

This option adds a 1.2 to 18 GHz phase detector to the HP 3048A to extend the carrier frequency of the test signals that can be demodulated without prior downconversion by the system. All of the HP 3048A specifications dependent on a carrier frequency range from 1.6 to 18 GHz are valid with this option.

### **OPTION 202: ADD SYSTEM RACK**

This option provides the HP 3048A system and its options installed in a full size instrument rack. Rack includes a power module, all necessary signal cabling, and a pull-out shelf to use as a work surface. Outside dimensions are approximately 163 H × 61 W × 81 D cm (64 × 24 × 32 inches). The net weight varies from 191 to 275 kg (418 to 603 lbs.) depending on the options installed. Shipping weight varies from 248 to 347 kg (543 to 758 lbs).

# Define Msrmnt

## MEASUREMENT DEFINITION

TO DEFINE A MEASUREMENT:

- 1) Specify Measurement Type and Freq. Range...[ Press 'Type / Range' ]
- 2) Enter Source and Interface Parameters....[ Press 'Instr. Params' ]
- 3) Specify a Calibration Process.....[ Press 'Calibr. Process' ]
- 4) Specify the Control of Signal Sources....[ Press 'Source Control' ]
- 5) Define the Graph of Results.....[ Press 'Define Graph' ]

To store/load a test definition to/from disk.....[ Press 'Test Files' ]

To view a summary of current parameters.....[ Press 'Param Summary' ]

To return to the MAIN SOFTWARE LEVEL.....[ Press 'DONE' ]

DONE	Param Summary	Test Files	HELP	Type Range	Instr. Params	Calibr. Process	Source Control	Define Graph
------	---------------	------------	------	------------	---------------	-----------------	----------------	--------------

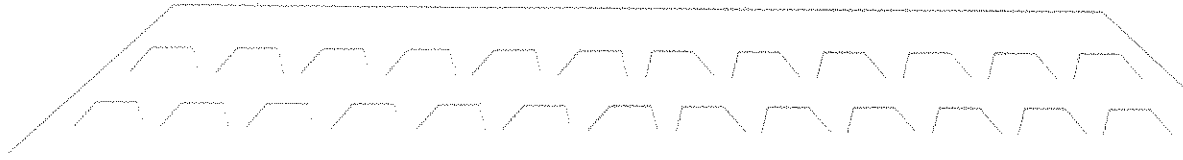

# Measurement Definitions

---

# 2

## Introduction

The Measurement Definition is the process of defining the measurement. This section describes the processes involved when the Define Msrmnt softkey is selected.

<b>Type/Range</b> .....	pg. 2-3
<b>Instrument Parameters</b> .....	pg. 2-13
<b>Calibration Process</b> .....	pg. 2-41
<b>Source Control</b> .....	pg. 2-101
<b>Define Graph</b> .....	pg. 2-115
<b>Test Files</b> .....	pg. 2-119

## Type/Range

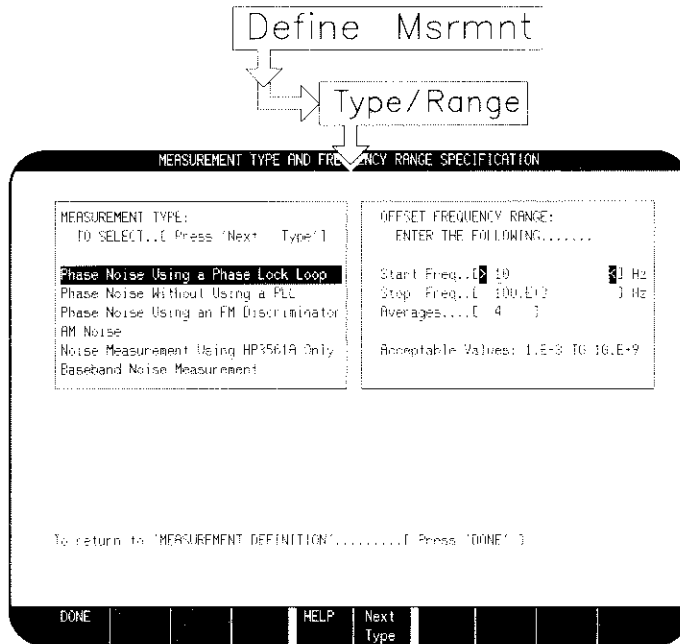

## Introduction

The Type/Range display enables you to define:

- The type of measurement you wish to make,
- The frequency offset span you wish to measure, and
- The minimum number of measurements you wish to have taken for averaging the noise in each segment of the offset span.



## Measurement Type

To select the correct type of measurement, you need to determine the type of noise to be measured and then the technique that best suits the device and available hardware.

Noise measurements can be categorized as either:

- Phase Noise Measurements,
- AM Noise Measurements, or
- Baseband Noise Measurements.

Press the **Next Type** softkey to position the inverse video window at the type of measurement you wish to perform.

---

### NOTE

The Measurement Type that you specify will determine which parameter entry fields appear in the remaining Measurement Definition displays.

---

## Phase Noise Measurements

**Phase Noise Using a Phase Lock Loop** measurement type is used to measure the Phase Noise of two sources, a Reference Source and the device under test (DUT) Source. A phase lock loop configuration is used to maintain quadrature during the measurement. This requires that one of the two sources is a VCO with an adequate tuning range to maintain phase lock between the sources.

SOURCE CONTROL FOR MEASUREMENT USING A PHASE LOCK LOOP

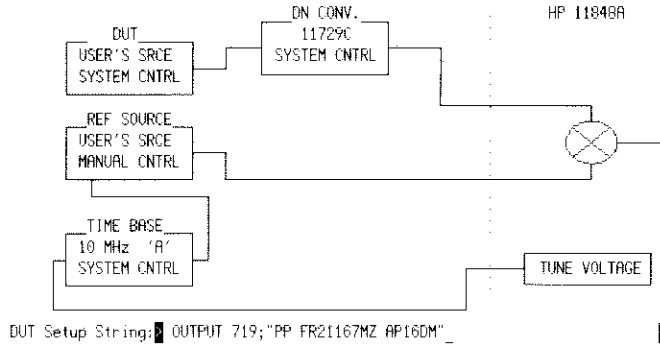

Done Control Tune Voltage HELP DUT Ref. Source Time Base Down Convert

Figure 2-1. Block Diagram of the Phase Lock Loop Measurement Configuration

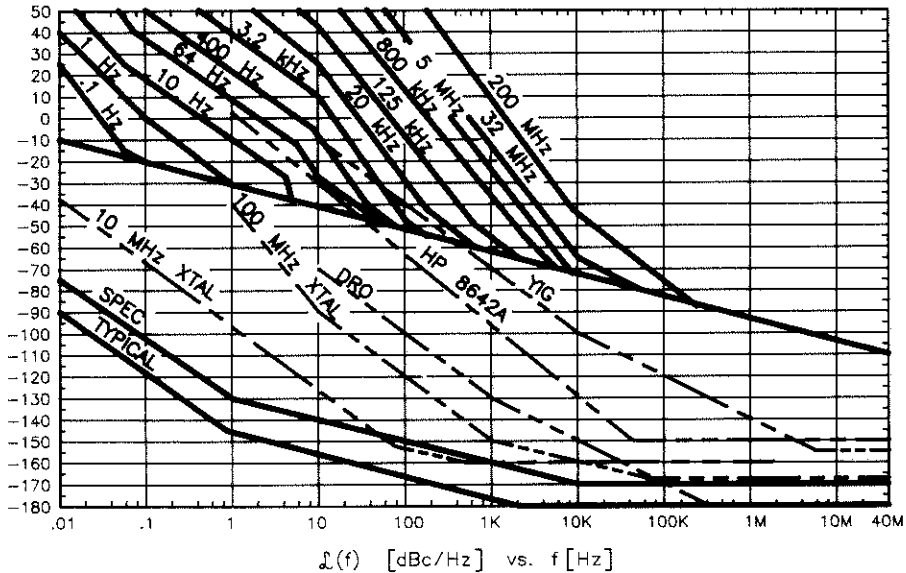
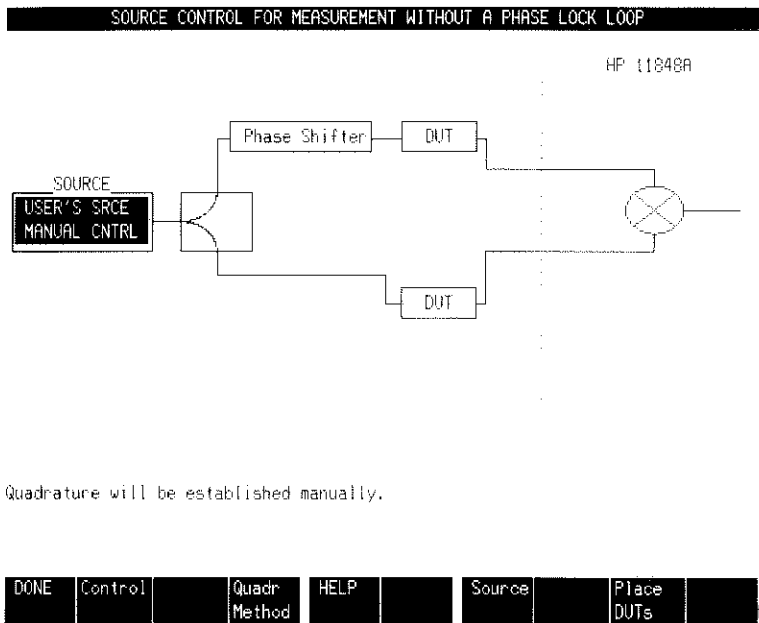

Figure 2-2. PTR Required to Phase Lock a Source.

**Phase Noise Without Using a PLL** measurement type is used to measure the residual phase noise of a Two Port (input/output) device. Two Port devices can be divided into two groups:

- Devices that translate the input frequency to a different output frequency, such as frequency multipliers and dividers. (The measurement setup for these types of devices requires that two similar devices be used.)

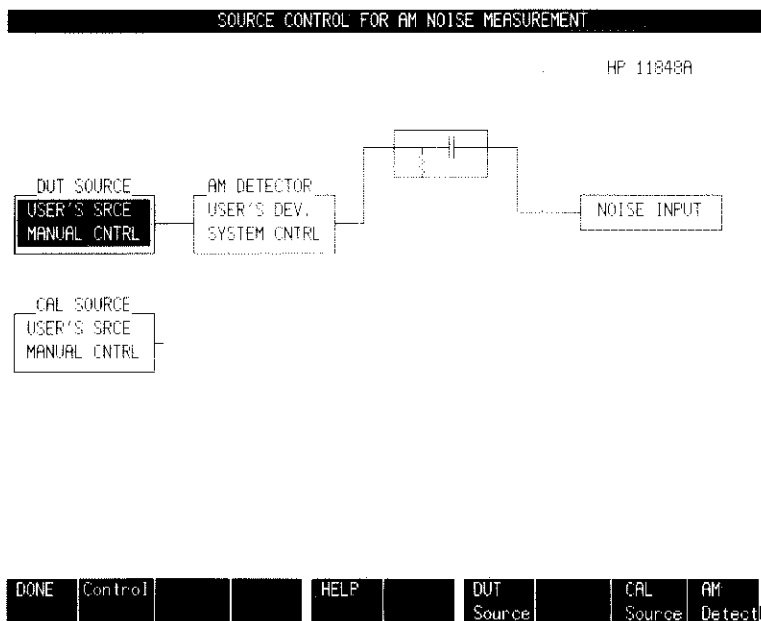

**Figure 2-3. Phase Noise Without Using a Phase Lock Loop Measurement Setup for Frequency Translator Devices**

- Devices that do not translate the input frequency, such as amplifiers and filters. For these devices, quadrature can often be attained by introducing the appropriate delay in one of the input paths, as shown in Figure 2-3, or by varying the source frequency. (Note that devices with large amounts of delay may require measurement of two similar devices, as shown for frequency translator devices.)

## AM Noise Measurements

The AM Noise measurement type is used to measure the AM Noise on a signal.



**Figure 2-4. Block Diagram of the AM Noise Measurement Configuration**

AM Noise can contribute to phase noise when a phase noise measurement is made. Phase detectors typically have 20 to 30 dB of AM rejection. Therefore, the AM Noise level should not exceed the level of the Phase Noise by more than 20 dB to insure that the AM Noise is not contributing to the phase noise measurement results. AM Noise affects the results of a Phase Noise measurement using an FM Discriminator much more strongly. An FM Discriminator implemented with a delay line and phase detector becomes increasingly sensitive to AM Noise at the rate of 20 dB/decade as the offset frequency decreases below  $\frac{1}{2\pi\tau}$ .

To make an AM Noise Measurement, an AM Detector is used to translate AM Noise to voltage fluctuations. A DC block (HP 3048A Option K21) is also required to eliminate any DC from overdriving the HP 11848A.

## Baseband Measurements

**The Noise Measurement Using the HP 3561A Only** baseband noise measurement measures the noise voltage of a device from .01 Hz to 100 kHz. This measurement type uses the HP 3561A Dynamic Signal Analyzer to measure the noise voltage directly.

Press the New Msrmnt softkey to begin the measurement. (This measurement type does not require any measurement calibration.)

---

### NOTE

Connect the signal source to the HP 3561A INPUT as shown in the Connect Diagram. It may be necessary to use a DC block to enable the HP 3561A to have maximum dynamic range. The HP 3561A is DC coupled in order to have flat response below 1 Hz.

---

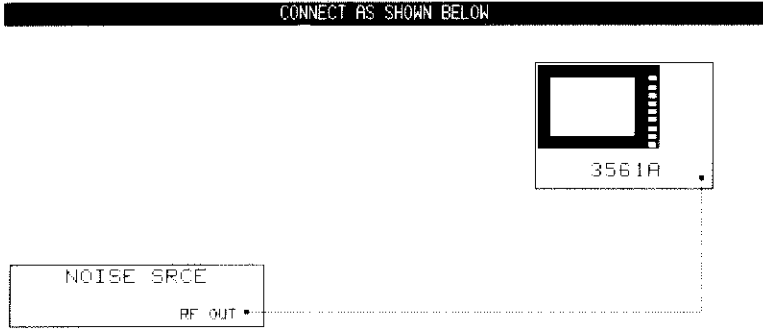

Press 'Proceed' when ready.



**Figure 2-5. Block Diagram of the HP 3561A Baseband Noise Measurement**

**Baseband Noise Measurement** measurement type uses the HP 11848A External Noise Input to direct the Noise Voltage to either the HP 3561A Dynamic Signal Analyzer or to a configured RF Analyzer. This extends the measurement range to 40 MHz. This measurement type also makes the internal LNA and High/Low Pass Filters within the HP 11848A available for the measurement.

---

### NOTE

The Baseband Noise Measurement will only measure out to 2 MHz if a Phase Detector Input frequency was set to less than 95 MHz in the previous measurement. To measure offsets greater than 2 MHz, verify the Phase Detector Input frequency is greater to 95 MHz before selecting the Baseband Noise Measurement in the Type/Range display.

---





## Range

The defined Start and Stop Frequencies specify the frequency range that will be measured by the HP 3048A.

## Averages

The minimum number of averages defined for the measurement determines the minimum number of noise level measurements the HP 3048A will make for each segment of the specified offset range. The HP 3048A will actually take more averages if the minimum number of averages specified in the Segment Table is greater than the number of averages specified here. (Refer to **FFT Segment Table** in Chapter 5, Special Functions, for further information about minimum averaging.)

# Instr. Params

## Introduction

The Instr. Params softkey accesses the menu for defining the characteristics of the measurement setup. The parameters defined in Instrument Parameters display inform the system about the following characteristics.

- **Frequency;** Carrier Frequency and Detector/Discr. Input Frequency.
- **VCO Tune Port Parameters;** Phase lock loop measurements only.
- **Detector Selection;** the HP 11848A's Phase Detector Inputs.

The HP 3048A uses the Instrument Parameter values to determine the hardware settings required for the measurement, and for calculations of the various Computed Outputs functions. The Measurement Type selected determines which Instrument Parameters are required. (The Noise Measurement Using HP 3561A Only and the Baseband Noise Measurement types do not require definition of any Instrument Parameters.)

<b>Phase Noise Using a Phase Lock Loop</b> .....	pg. 2-14
<b>Phase Noise Without Using a PLL</b> .....	pg. 2-31
<b>Phase Noise Using an FM Discriminator</b> .....	pg. 2-35
<b>AM Noise</b> .....	pg. 2-38
<b>Noise Measurement Using HP 3561A Only</b> ..	No Instr. Parameters required
<b>Baseband Noise Measurement</b> .....	No Instrument Parameters required

# Phase Noise Using a Phase Lock Loop

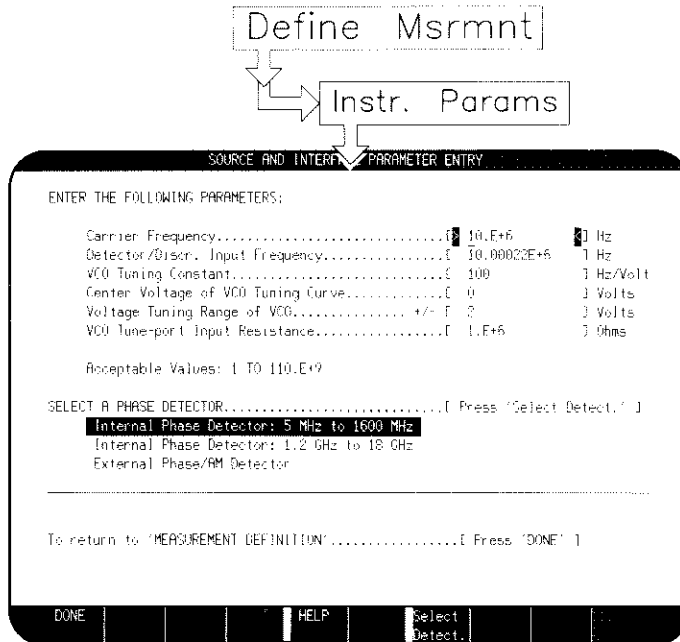

## Frequency Parameters

**Carrier Frequency** is the fundamental (center) frequency of the device you are measuring. The HP 3048A uses the Carrier Frequency entry to:

- Label the Carrier Frequency on the Results Graph.
- Select the correct bandpass filter for the HP 11729C, when it is configured in the system as a Down Converter.
- Calculate Sigma vs. Tau and  $S_y(f)$ .

---

## NOTE

When loading a Result File for calculating Sigma vs. Tau, the carrier frequency used for the measurement must be entered in the Instrument Parameters display in order to compute accurate values.

---

**Detector/Discr. Input Frequency** is the frequency of the input signal connected to the HP 11848A's phase detector. The Detector/Discriminator Input Frequency is used to:

- Select the appropriate Low Pass Filter (LPF) in the HP 11848A Phase Noise Interface. For frequencies < 95 MHz, the system enables the 2 MHz LPF to eliminate feedthrough of the fundamental signal and the additive products out of the phase detector. When the 2 MHz LPF is enabled, the maximum offset frequency the system can measure is 2 MHz.
- Set the frequency of the Reference Source when the Reference Source is under system control.
- When using an HP 11729C under System Control, the HP 3048A will derive the correct Detector/Discr. Input Frequency and enter it into the Instrument Parameter display. If the currently entered Detector/Discr. Input Frequency is less than 95 MHz, and you are allowing the HP 3048A to input the correct Detector/Discr. Input Frequency by computing the value from a System Controlled HP 11729C, then the measured offset range will be limited to 2 MHz. To eliminate this problem, set the Detect/Discr. Input Frequency to a frequency greater than 95 MHz.

## Frequency Parameter Considerations

- If the Carrier Frequency defined for the measurement is incorrect, the Computed Output calculations may be in error. Verify that the Carrier Frequency displayed on the Result Graph is the correct frequency.

Also, when using an HP 11729C under system control, an incorrect Carrier Frequency entry can result in an incorrect filter selection.

- The HP 3048A will change the Detector/Discr. Input Frequency and update the Instrument Parameter display when a Source is under System Control and a frequency change was required to zero the beatnote. If the change in frequency changes other parameters such as Peak Deviation for DC FM, the HP 3048A will inform you of the change and allow you to proceed with the new setting or abort the measurement.
- The system will not allow a Detector/Discr. Input Frequency of less than 5 MHz. If you are using an external Phase Detector at a frequency  $< 5\text{MHz}$ , enter the fundamental frequency as the carrier frequency and 5 MHz or the Detector/Discr. frequency. (Note that when measuring frequency  $< 5\text{MHz}$  you must filter out the fundamental carrier external to the HP 11848A.)

## VCO Tune Port Parameters

**VCO Tuning Constant** is the resulting frequency deviation of the Voltage Controlled Oscillator (VCO) for a 1 volt change at its tune port. This entry must be accurate to within  $\pm 5\%$  when the HP 3048A is not going to measure the VCO Tuning Constant. The entry must be accurate to within a factor of 2 when the VCO Tuning Constant is going to be measured by the HP 3048A.

**Center Voltage of VCO Tuning Curve** is the center voltage of the tuning curve of the VCO or the voltage required at the tune port input to set the VCO to the desired carrier frequency for the measurement. A 0 volt entry allows the maximum Voltage Tune Range available from the HP 11848A. Entries other than zero restrict the Voltage Tune Range as described below:

Center Voltage	Maximum Voltage Tuning Range
$\leq 2V$	$\pm 10V$
$> 2V$	$\pm 12V - \text{Center Voltage}$

**Voltage Tuning Range of VCO** is the  $\pm$  peak voltage available to tune the VCO. This entry along with the VCO Tuning Constant determines the Peak Tuning Range available.

$$VCO \text{ Tuning Constant} \times \text{Voltage Tuning Range} \approx \text{Peak Tuning Range}$$

---

### NOTE

Prior to initiating a New Measurement at the HP 11848A Tune Voltage Output port, an output voltage of as high as  $\pm 12V$  may be present at the HP 11848A Tune Voltage output port from a previous measurement setting. It is recommended that you wait to connect the VCO's tune port to the Tune Voltage output until the Connect Diagram appears to avoid possible damage to your VCO.

The Tune Voltage Output port on the rear panel of the HP 11848A provides an inverted output of the tune voltage.

---

**VCO Tune-port Input Resistance** is the input impedance of the VCO's tune port. This entry must be accurate to within  $\pm 5\%$  when the VCO Tuning Constant is not going to be measured. When the Tuning Constant is going to be measured by the HP 3048A, the actual value of the VCO Tune-port Input Resistance is not critical, and an entry of 1E+6 is recommended. (The HP 11848A drives the tune port through a  $50\Omega$  series resistor and is restricted to 20 mA of output current.)

## The Peak Tuning Range

The Peak Tuning Range (PTR) is one half of the total (peak to peak) tuning range defined for the VCO in the Instrument Parameter display.

The Instrument Parameter entries for the VCO Tuning Constant, Voltage Tuning Range, and Tune-port Input Resistance are used by the HP 3048A to determine the PTR for the PLL measurement.

$$PTR \approx VCO \text{ Tuning Constant} \times \left( \frac{R_{load}}{R_{load} + 50} \right) \times Voltage \text{ Tuning Range}$$

There are three primary considerations for determining the Peak Tuning Range (PTR) required for your measurement.

- Adequate Drift Tracking
- Sufficient Phase Lock Loop Bandwidth, and
- Sufficient Noise Floor Level

These three considerations must be traded-off against one another to determine the optimum PTR for your measurement. That is to say, higher PTRs (recommended for initial measurements) ensure adequate drift tracking and Phase Lock Loop bandwidths (PLL BW) at the expense of higher noise floors.

The Peak Tuning Range determines the Drift Tracking Range (20% of PTR), and the PLL Capture Range (10% of PTR) for the measurement.

$$\text{Peak Tuning Range (PTR)} \approx \text{Voltage Tuning Range} \times \text{VCO Tuning Constant}$$

$$\text{Min. PTR} = .1 \text{ Hz}$$

$$\text{Max. PTR} = 500 \text{ kHz (200 MHz with an RF Analyzer).}$$

$$\text{Drift Tracking Range} = \text{Allowable Drift During Measurement.}$$

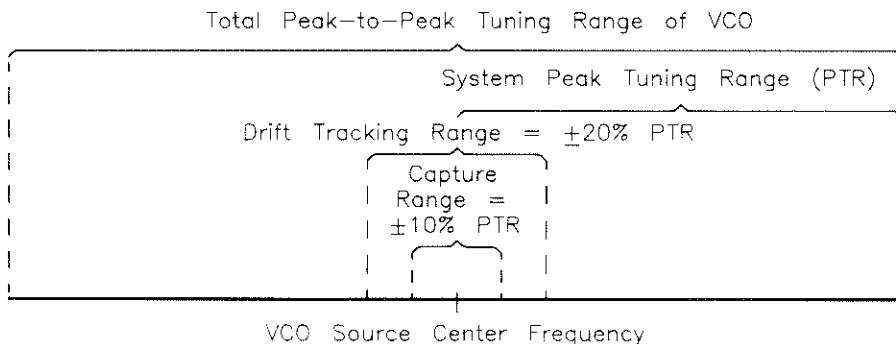

**Figure 2-7. Typical Relationship of Capture Range and Drift Tracking Range to Tuning Range of the VCO Source**

## Determining the PTR Required for Drift Tracking

The following procedure will help you determine the PTR required to provide adequate drift tracking.

1. Observe or estimate the combined drift range of the sources.



2. If the drift estimate is based on a period of 10 minutes to  $\frac{1}{2}$  hour, use the drift estimate directly as the PTR required for the measurement.

If the drift estimate is short term (10 seconds to 1 minute), multiply the drift estimate by 100 to determine the required PTR. A factor of 100 is recommended to ensure that the HP 3048A has sufficient Drift Tracking range to complete the initial noise measurement. (Refer to *Noise Floor Level* in this section for information about reducing the PTR for subsequent measurements to verify the measurement noise floor.)

3. Divide the required PTR by the VCO's Tune Voltage Range to determine the VCO Tuning Constant required for the measurement.

---

### NOTE

The PTR can also be modified by changing the Voltage Tuning Range of the VCO value defined for measurement.

---

## Noise Floor Level

The noise floor available for the measurement can be limited by the presence of noise at the VCO control port. Narrowing the PTR can reduce the effect of the control port noise thereby reducing the measurement noise floor. Figure 2-8 shows the noise floor limits for various PTRs.

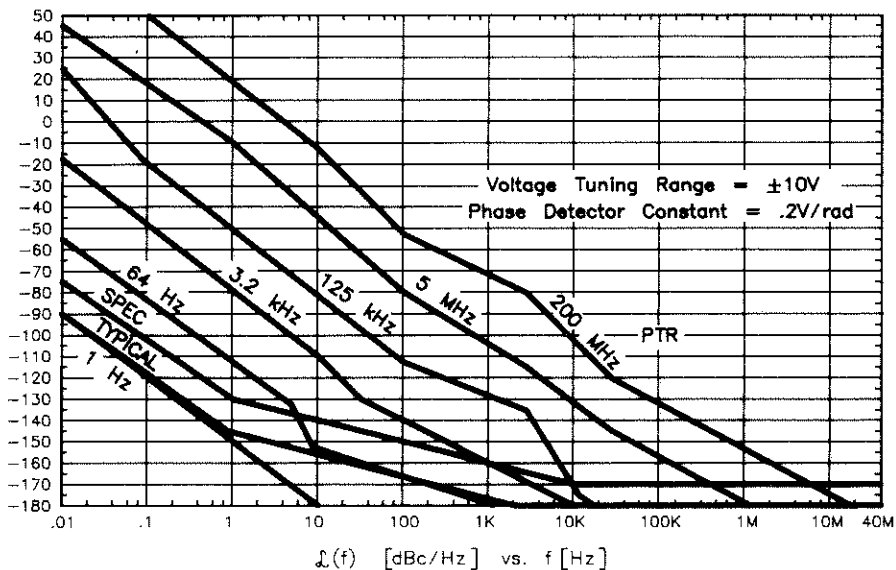

Figure 2-8. Noise Floor Level Limits for Various PTRs

If you maximized the PTR for your initial measurement to ensure that the HP 3048A has adequate drift tracking capability to complete the PLL measurement, it is recommended that you incrementally reduce the PTR and initiate a new measurement to verify that your Measurement Results are not being limited by the Noise Floor of the system. Continue to lower the PTR (by reducing the Tuning Constant or Voltage Tuning Range) and make new measurements until there is no subsequent reduction in the measured noise floor, or until the HP 3048A is no longer able to acquire or maintain phase lock.

## Phase Lock Loop Bandwidth

The PTR also determines the Phase Lock Loop Bandwidth (PLL BW) for the measurement as shown in Figure 2-9.

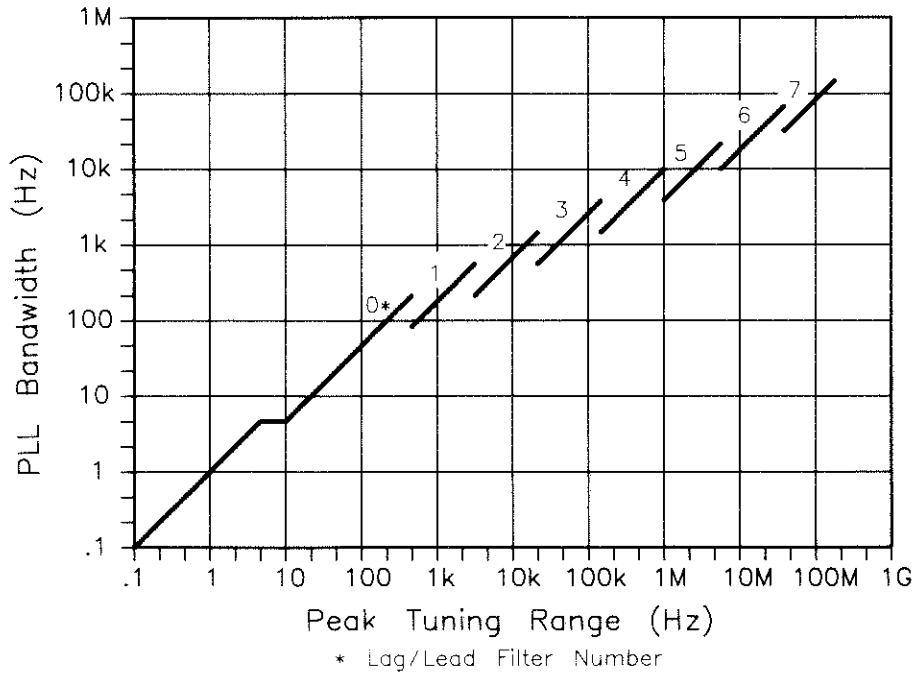
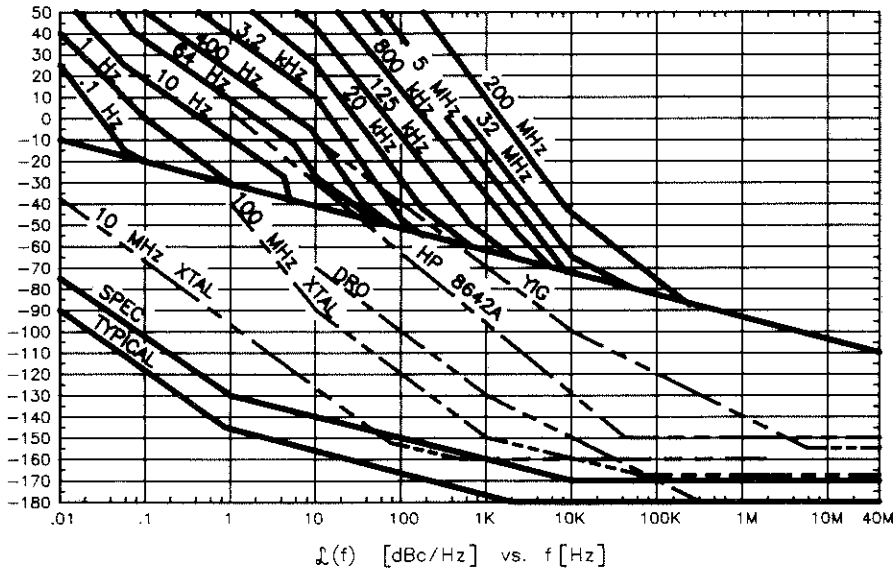

Figure 2-9. Phase Lock Loop Bandwidth as a Function of the Peak Tuning Range

The PLL BW requirement for the measurement is a function of the average noise level of the signal sources. If the average noise level on the input signals exceeds approximately 0.1 radians RMS outside of the Phase Lock Loop (PLL) bandwidth, it can prevent the HP 3048A from attaining phase lock. Figure 2-10 shows the PTR required to provide an adequate PLL BW for given average noise levels.



**Figure 2-10. Graph Showing Peak Tuning Range Required to Provide an Adequate Phase Lock Loop Bandwidth for Given Average Noise Levels.**

## VCO Tuning Linearity

The HP 3048A requires that the VCO's tuning curve nonlinearity not exceed the limits described in Figure 2-11 out to  $\pm 45\%$  of the center voltage defined for the measurement.

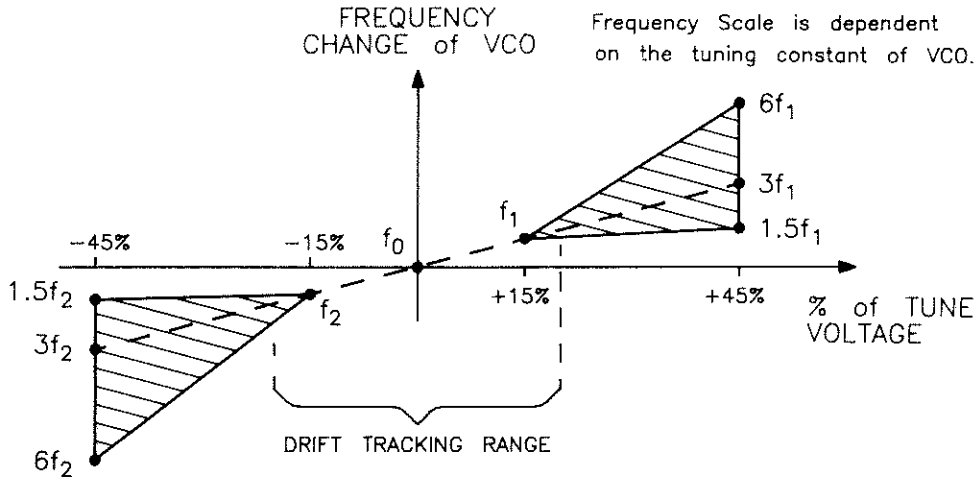

**Figure 2-11. VCO Tuning Linearity Required for Phase Lock Loop Measurements**

where:  $f_0$  = The frequency of the Beatnote at the Center Voltage.

and:  $f_1$  = The + 15% point of the Voltage Tune Range.

$f_2$  = The - 15% point of the Voltage Tune Range.

$(6f_1$  to  $1.5f_1)$  and  $(6f_2$  to  $1.5f_2)$  are the limits for the  $\pm 45\%$  points of the Voltage Tune Range.

## Measuring the VCO Tuning Constant

The following procedure describes the HP 3048A process for measuring the VCO Tuning Constant.

1. The HP 3048A drives the VCO's tune port to  $-45\%$ ,  $-15\%$ ,  $+15\%$ ,  $+45\%$  of the defined Voltage Tuning Range and measures the frequency of the beatnote at each of these settings.
2. The  $\pm 15\%$  frequencies are used to derive the limits for the  $\pm 45\%$  frequencies. The HP 3048A requires that at  $\pm 45\%$  of the Voltage Tuning Range the VCO's tuning response must be within 1.5 to 6 times the frequency of the  $\pm 15\%$  points.
3. The HP 3048A verifies that the frequencies measured at  $\pm 45\%$  of the Voltage Tuning Range are within these computed limits.

---

### NOTE

The VCO Tuning Constant must be monotonic and have a slope other than zero in addition to meeting the linearity requirements.

---

4. If the  $\pm 45\%$  points are within the limits, the system uses the slope between the  $\pm 15\%$  points as the VCO Tuning Constant.

## Center Frequencies not at Center Voltage

If the center frequency for the measurement ( $f_0$ ) is not at the specified center voltage, then the  $f_1$  and  $f_2$  frequencies must be translated relative to the center frequency offset as well as the  $\pm 45\%$  limits.

## Detector Selection

The Select Detect. softkey provides selection between the HP 11848A Phase Detectors. Verify that the selected Phase Detector is:

- Within the frequency range of the Detector/Discr. Input Frequency entered.
- Installed in the HP 11848A Phase Noise Interface. (Option 201 adds the 1.2 to 18 GHz Phase Detector to the HP 11848A).

Detector Selection	Required Level (dBm)	
	L Port	R Port
Internal 5 MHz to 1.6 GHz	+15 to +23	0 to +23
Internal 1.2 GHz to 18 GHz	+7 to +10	0 to +10
External	As specified for the detector used	As specified for the detector used

## External Detectors

Using an External Phase Detector to measure a device with fundamental frequency less than 5 MHz or greater than 18 GHz requires special considerations. The HP 3048A limits the Detector/Discr. Input Frequency range to from 5 MHz to 18 GHz. If you are measuring a device that exceeds the limits of the Detector/Discr. Input Frequency, enter a frequency of less than 95 MHz for a device with a frequency of less than 5 MHz to enable the 2 MHz LPF, or enter a frequency of greater than 95 MHz for a device with a frequency greater than 18 GHz to remove the 2 MHz LPF. Also when measuring frequencies less than 5 MHz you must filter out the fundamental feedthrough and additive product prior to the HP 11848A Noise Input. This is necessary to prevent overloading.

## Enhanced Tuning Range Using a Calibrated DC FM Source

Enhanced Tuning Range is a method to increase the PTR by using the total available tuning range of the VCO. The VCO must have a calibrated DC FM output accurate within to 5% of the indicated rate, and can except input voltages exceeding the calibrated voltage range without damage.

The Enhanced Tuning Range can be used to decrease the systems noise floor when using DC FM. By allowing a larger PTR with the minimum VCO Tuning Constant (Peak Deviation) the system can phase lock a drift source without increasing the peak deviation. Enhanced Tuning Range increases the PTR thereby increasing the Drift Tracking Range and Capture Range without changing the VCO Tuning Constant (Peak Deviation) . This feature allows you to measure a noisy or drift source, that would normally exceed the phase lock loops ability to maintain phase lock, without increasing the VCO's Tuning sensitivity. The noise floor is limited by sensitivity of the VCO Tune'Port, (refer to *12 HP 3048A Noise Floor Limits Due to Peak Tuning Range* in Chapter 7, Quick Reference, to see the graphic relationship of noise floor to PTR).

---

### NOTE

You cannot use this feature on a VCO that does not have a known Tuning Constant (within  $\pm 5\%$ ) or if the VCO could be damaged by applying voltages (Typically  $\pm 10$  volts) that exceed the Tune Port requirements.

---



## How do You Enhance the Tuning Range?

The Enhanced Tuning Range allows the system to use the total VCO Tuning Range available from a calibrated DC FM Source when Defining the Measurement:

- Enter the VCO Tuning Constant and the Tune Port Resistance in the Instrument Parameter display. These entries must be within  $\pm 5\%$  of their actual values for the measurement to be properly calibrated. The verification of the Loop Suppression will verify the entered accuracy of the VCO Tuning Constant, Tune Port Resistance, and Phase Detector Constant.
- Enter a Voltage Tuning Range 5 to 10 times the maximum voltage required to achieve the peak deviation of the VCO. This artificially increases the PTR. (The HP 3048A will allow a maximum Voltage Tune Range of  $\pm 10$  volts).
- Choose "Compute from expected T. Constant" in the Calib. Process display. This restricts the system from measuring the non-linear VCO Tuning Constant.
- Verify the Beatnote is less than 10% of the PTR at the Connect Diagram. This insures the System can Zero-Beat the sources and measure the Phase Detector Constant. (Phase Detector Constant must be entered in the Calib. Process display if it cannot be measured by the system).

## Considerations with Enhancing the Tuning Range.

- The system is instructed to use a Voltage Tuning Range that exceeds the calibrated Tune Port input of the VCO. Typically a Voltage Tune Range of 5 to 10 volts is entered at the Instrument Parameter display to artificially increase the PTR by 5 to 10 times. This increases the Drift Tracking Range allowed which is 20% of the PTR enabling the System to use the total VCO Tuning Range available. For example an HP 8663A with 10 kHz DC FM and 1 volt peak deviation would normally result in a PTR of 10 kHz and a Drift Tracking Range of 2 kHz. Any drift greater than 2 kHz the system would break lock because the HP 8663A was restricted to  $\pm .2$  volts at the tune port and could not track the drift. With Enhanced Tuning applied the system would think that the same HP 8663A would have a PTR of  $10 \times$  the peak deviation of 10 kHz, or 100 kHz. This allows a Drift Tracking Range of 20 kHz and a Capture Range of 10 kHz. Even though the Enhance Drift Tracking Range exceeds the peak deviation of the HP 8663A the system will track the sources until the Voltage Tune Range exceeds 20% of the Voltage Tuning Range or the VCO fails to compensate for the drift due to its capabilities. (non-linearity).

---

### NOTE

The System will apply the full Voltage Tuning Range when the phase lock is lost. The 1.6 Hz Search Oscillator internal to the HP 11848A Interface is enabled to swing the Voltage Tune Port  $\pm$  the Voltage Tuning Range this allows the system to re-lock the loop when possible under normal tuning.

---

- When Enhanced Tuning Range is used the system is unable to measure the VCO Tuning Constant and you must select the “Compute from Expected T. Constant” in the Calib. Process display, and enter the exact VCO Tuning Constant and Tune Port Resistance in the Instrument Parameter display. Normally the System measures the VCO Tuning Constant by applying  $\pm 15$  and 45% of the Voltage Tuning Range to the tune port of the VCO. Enhanced Tuning Range increases the Voltage Tuning Range to where 45% of the Voltage Tuning Range would drive the tune port into its non-linear region. This would create a VCO non-linear error message and stop the measurement.
- The Verification of the Phase Lock Loop Suppression is recommended to ensure the validity of the entered VCO Tuning Constant and the Phase Detector Constant.
- The beatnote must be within 10% of the PTR to insure that the system can measure the Phase Detector Constant. The software applies 10% of the Voltage Tuning Range to create a beatnote to measure the Phase Detector Constant.

# Phase Noise Without Using a PLL

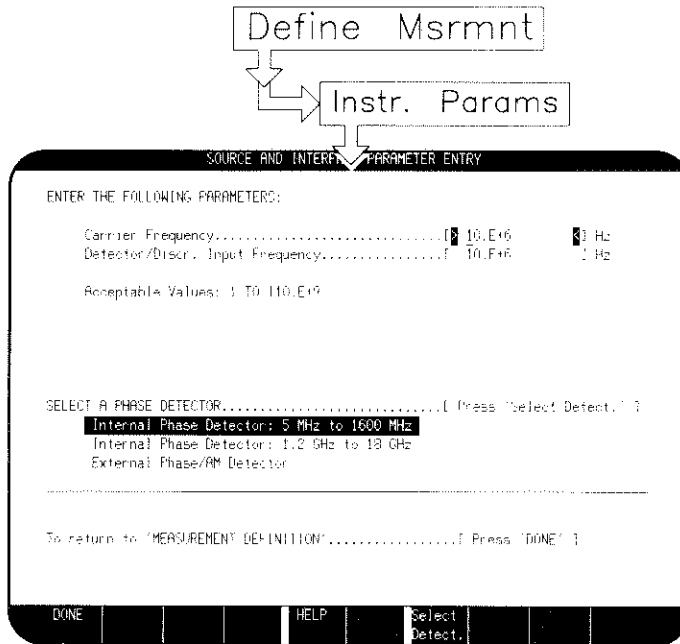

## Frequency Parameters

**Carrier Frequency** is the fundamental (center) frequency of the device you are measuring. The HP 3048A uses the Carrier Frequency entry to:

- Label the Carrier Frequency on the Results Graph.
- Select the correct bandpass filter for the HP 11729C, when it is configured in the system as a Down Converter.
- Calculate Sigma vs. Tau and  $S_y(f)$ .

---

## NOTE

When loading a Result File for calculating Sigma vs. Tau, the carrier frequency used for the measurement must be entered in the Instrument Parameters display in order to compute accurate values.

---

**Detector/Discr. Input Frequency** is the frequency of the input signal connected to the HP 11848A's phase detector. The Detector/Discriminator Input Frequency is used to:

- Select the appropriate Low Pass Filter (LPF) in the HP 11848A Phase Noise Interface. For frequencies < 95 MHz, the system enables the 2 MHz LPF to eliminate feedthrough of the fundamental signal and the additive products out of the phase detector. When the 2 MHz LPF is enabled, the maximum offset frequency the system can measure is 2 MHz.
- Set the frequency of the Reference Source when the Reference Source is under system control.

---

## NOTE

When using an HP 11729C under System Control, the HP 3048A will derive the correct Detector/Discr. Input Frequency and enter it into the Instrument Parameter display. If the currently entered Detector/Discr. Input Frequency is less than 95 MHz, and you are allowing the HP 3048A to input the correct Detector/Discr. Input Frequency by computing the value from a System Controlled HP 11729C, then the measured offset range will be limited to 2 MHz. To eliminate this problem, set the Detect/Discr. Input Frequency to a frequency greater than 95 MHz.

---

## Frequency Parameter Considerations

- If the Carrier Frequency defined for the measurement is incorrect, the Computed Output calculations may be in error. Verify that the Carrier Frequency displayed on the Result Graph is the correct frequency. When computing Sigma of Tau from a Result File you must ensure that the Carrier Frequency in the Instrument Parameter display represents the carrier frequency of the Result File.

Also, when using an HP 11729C under system control, an incorrect Carrier Frequency entry can result in an incorrect filter selection.

## Detector Selection

The Select Detect. softkey provides selection between the HP 11848A Phase Detectors. Verify that the selected Phase Detector is:

- Within the frequency range of the Detector/Discr. Input Frequency entered.
- Installed in the HP 11848A Phase Noise Interface. (Option 201 adds the 1.2 to 18 GHz Phase Detector to the HP 11848A).

Detector Selection	Required Level (dBm)	
	L Port	R Port
Internal 5 MHz to 1.6 GHz	+15 to +23	0 to +23
Internal 1.2 GHz to 18 GHz	+7 to +10	0 to +10
External	As required for the detector used	As required for the detector used

## External Detectors

Using an External Phase Detector to measure a device with fundamental frequency less than 5 MHz or greater than 18 GHz requires special considerations. The HP 3048A limits the Detector/Disc. Input Frequency range to from 5 MHz to 18 GHz. If you are measuring a device that exceeds the limits of the Detector/Disc. Input Frequency, enter a frequency of less than 95 MHz for a device with a frequency of less than 5 MHz to enable the 2 MHz LPF, or enter a frequency of greater than 95 MHz for a device with a frequency greater than 18 GHz to remove the 2 MHz LPF. Also when measuring frequencies less than 5 MHz you must filter out the fundamental feedthrough and additive product prior to the HP 11848A Noise Input. This is necessary to prevent overloading.

# Phase Noise Using an FM Discriminator

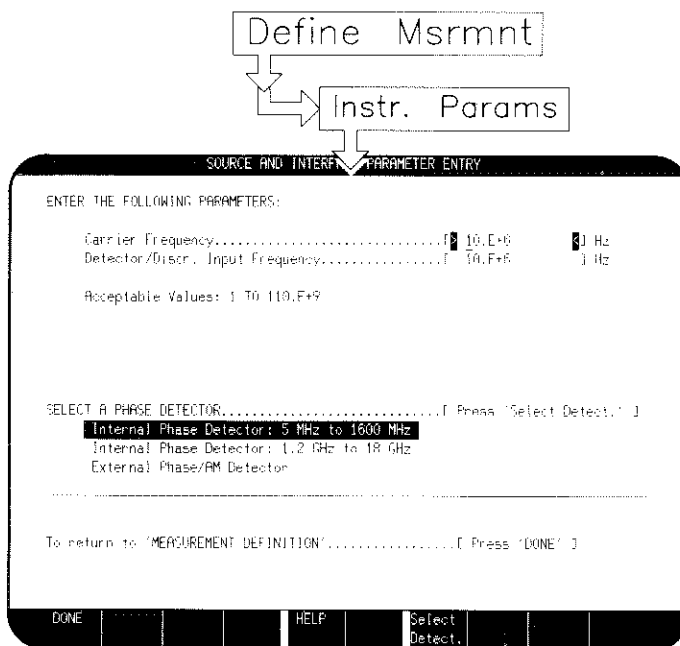

## Frequency Parameters

**Carrier Frequency** is the fundamental (center) frequency of the device you are measuring. The HP 3048A uses the Carrier Frequency entry to:

- Label the Carrier Frequency on the Results Graph.
- Calculate Sigma vs. Tau and  $S_y(f)$ .

---

### NOTE

When loading a Result File for calculating Sigma vs. Tau, the carrier frequency used for the measurement must be entered in the Instrument Parameters display in order to compute accurate values.

---



**Detector/Discr. Input Frequency** is the frequency of the input signal connected to the HP 11848A's phase detector. The Detector/Discriminator Input Frequency is used to:

- Select the appropriate Low Pass Filter (LPF) in the HP 11848A Phase Noise Interface. For frequencies  $< 95$  MHz, the system enables the 2 MHz LPF to eliminate feedthrough of the fundamental signal and the additive products out of the phase detector. When the 2 MHz LPF is enabled, the maximum offset frequency the system can measure is 2 MHz.
- Set the frequency of the Calibration Source when the Calibration Source is under system control.

### **Frequency Parameter Considerations**

- If the Carrier Frequency defined for the measurement is incorrect, the Computed Output calculations may be in error. Verify that the Carrier Frequency displayed on the Result Graph is the correct frequency. When computing Sigma of Tau from a Result File you must ensure that the Carrier Frequency in the Instrument Parameter display represents the carrier frequency of the Result File.

Detector Selection	Required Level (dBm)	
	L Port	R Port
Internal 5 MHz to 1.6 GHz	+15 to +23	0 to +23
Internal 1.2 GHz to 18 GHz	+7 to +10	0 to +10
External	As required for the detector used	As required for the detector used

## Detector Selection

The Select Detect. softkey provides selection between the HP 11848A Phase Detectors. Verify that the selected Phase Detector is:

- Within the frequency range of the Detector/Discr. Input Frequency entered.
- Installed in the HP 11848A Phase Noise Interface. (Option 201 adds the 1.2 to 18 GHz Phase Detector to the HP 11848A).

## External Detectors

Using an External Phase Detector to measure a device with fundamental frequency less than 5 MHz or greater than 18 GHz requires special considerations. The HP 3048A limits the Detector/Discr. Input Frequency range to from 5 MHz to 18 GHz. If you are measuring a device that exceeds the limits of the Detector/Discr. Input Frequency, enter a frequency of less than 95 MHz for a device with a frequency of less than 5 MHz to enable the 2 MHz LPF, or enter a frequency of greater than 95 MHz for a device with a frequency greater than 18 GHz to remove the 2 MHz LPF. Also when measuring frequencies less than 5 MHz you must filter out the fundamental feedthrough and additive product prior to the HP 11848A Noise Input. This is necessary to prevent overloading.

# AM Noise

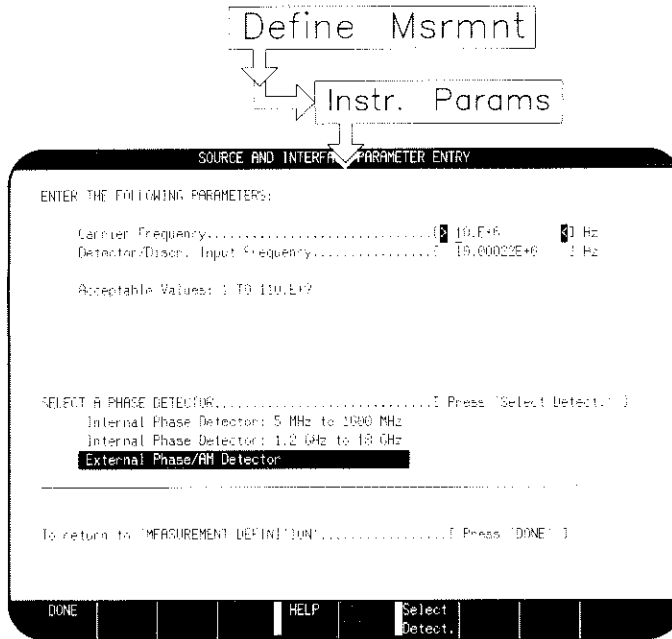

## Frequency Parameters

**Carrier Frequency** is the fundamental (center) frequency of the device you are measuring. The HP 3048A uses the Carrier Frequency entry to:

- Label the Carrier Frequency on the Results Graph.
- Calculate Sigma vs. Tau and  $S_y(f)$ .

---

### NOTE

When loading a Result File for calculating Sigma vs. Tau, the carrier frequency used for the measurement must be entered in the Instrument Parameters display in order to compute accurate values.

---

**Detector/Discr. Input Frequency** is the frequency of the input signal connected to the AM Detector. The Detector/Discriminator Input Frequency is used to:

- Select the appropriate Low Pass Filter (LPF) in the HP 11848A Phase Noise Interface. For frequencies  $< 95$  MHz, the system enables the 2 MHz LPF to eliminate feedthrough of the fundamental signal and the additive products out of the phase detector. When the 2 MHz LPF is enabled, the maximum offset frequency the system can measure is 2 MHz.
- Setup the HP 11729C option 003 as an AM Detector if under System Control.

## Frequency Parameter Considerations

- If the Carrier Frequency defined for the measurement is incorrect, the Computed Output calculations may be in error. Verify that the Carrier Frequency displayed on the Result Graph is the correct frequency. When computing Sigma of Tau from a Result File you must ensure that the Carrier Frequency in the Instrument Parameter display represents the carrier frequency of the Result File.

## Detector Selection

For AM Noise measurement the “External Phase/AM Detector” should be selected. Pressing the Select Detect. softkey will change the Phase Detector selection. (The inverse video indicates which HP 11848A phase detector is defined for the measurement.)

## AM Detector Considerations

When using an AM Detector you should consider:

- The frequency range of the AM Detector.
- The power level the AM Detector can tolerate.
- The sensitivity (Detector Constant) of the AM Detector selected.
- The frequency range and flatness of the DC Block.

Connector	Frequency Range	Maximum Level
NOISE INPUT	DC to 40 MHz	1V Peak

# Calibr Process

## Introduction

The Calibration Process softkey accesses the menu for defining the calibration method for the measurement. The calibration methods available for the measurement depend on the Measurement Type selected.

<b>Phase Noise Using a Phase Lock Loop</b> .....	pg. 2-42
<b>Phase Noise Without Using a Phase Lock Loop</b> .....	pg. 2-57
<b>Phase Noise Using an FM Discriminator</b> .....	pg. 2-75
<b>AM Noise</b> .....	pg. 2-89
<b>Noise Measurement Using HP 3561A Only</b> .....	pg. 100.1
<b>Baseband Noise Measurement</b> .....	pg. 100.2

# Calibration for the Phase Noise Using a Phase Lock Loop Measurement

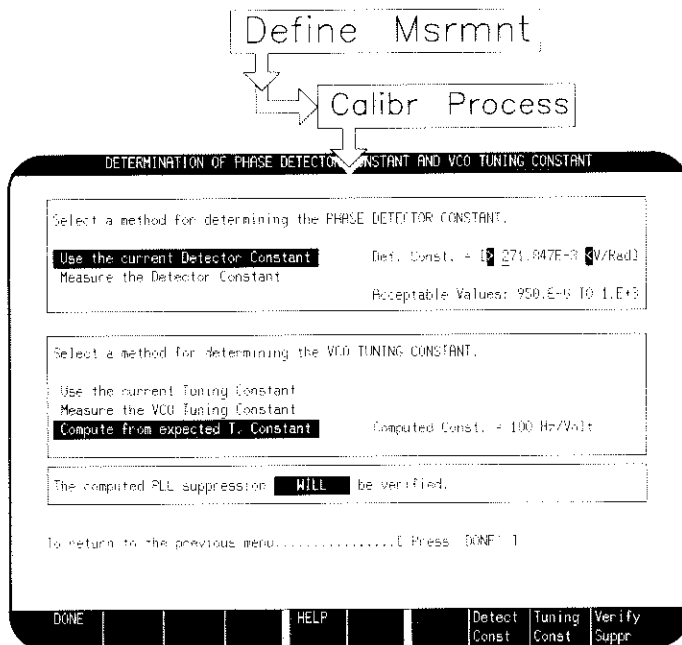

## Introduction

The calibration process for a phase lock loop measurement involves determining the Phase Detector Constant, the VCO Tuning Constant, and verifying the Loop Suppression. The Phase Detector Constant is the sensitivity of the phase detector expressed in volts per radian (V/Rad). The VCO Tuning Constant is the sensitivity of the tuning input of the Voltage Controlled Oscillator (VCO) expressed in Hertz per volt (Hz/V). The Loop Suppression verification characterizes the phase lock loop configured for the measurement and then compares the measured loop response with a theoretical loop suppression curve.

<b>The Phase Detector Constant</b> .....	pg.43
<b>The VCO Tuning Constant</b> .....	pg.50
<b>The Verification of the Phase Lock Loop Suppression</b> .....	pg.54

# The Phase Detector Constant

## Introduction

The phase detector translates relative phase fluctuations between the two phase detector inputs to voltage fluctuations. The amplitude of the phase detector's output voltage is proportional to the amount of relative phase fluctuation at its two inputs scaled by and the sensitivity of the detector. The phase detector's sensitivity is the Phase Detector Constant. The Phase Detector Constant determines the absolute noise floor of the system. The accuracy of the Phase Lock Loop measurement is dependent on the accuracy of the Phase Detector Constant.

"Use the Current Detector Constant" and "Measure the Detector Constant" are the two methods available for determining the Phase Detector Constant. The HP 3048A uses the method displayed in inverse video. The Detect Const softkey allows you to select the desired method.

Calibration Method	Considerations
Use the Current Detector Constant	Uses the displayed value (in memory from the last measurement or from user entry). This method saves measurement time by eliminating the Phase Detector Calibration from the measurement process.
Measure the Detector Constant	Recommended method to ensure measurement accuracy.



## Parameter Entry Descriptions

### Use the Current Detector Constant

**When measuring similar devices** the “Use the Current Detector” method can be used to save calibration time. The system assumes that the frequency and amplitude are identical to the previous measurement in which the Phase Detector Constant was established. In most cases, the accuracy uncertainty is negligible as long as the power levels are very close ( $\pm 0.3$  dB) to the levels present when the Phase Detector Constant was established.

**User entry** of the Phase Detector Constant (within the range of Acceptable Values displayed) is possible when the sensitivity of the detector being used is known. Entering the Phase Detector Constant can be helpful when the system is unable to measure the Phase Detector Constant. Keep in mind that the accuracy of the measurement is dependent on the accuracy of the Phase Detector Constant. The HP 3048A verifies the accuracy of the entered Phase Detector Constant when it is configured to verify the Phase Lock Loop Suppression. An Accuracy Specification Degradation will be reported if the entered Phase Detector Constant is in error.

The sensitivity of the phase detector is a function of the input level to the phase detector. You can estimate the Phase Detector Constant directly from the input power level at the R port of the phase detector; providing the input level required for driving the L port of the phase detector has been met. A power meter or a spectrum analyzer can be used to measure the input level at the R port. Compare the measured R port level to graph below to estimate the Phase Detector Constant.

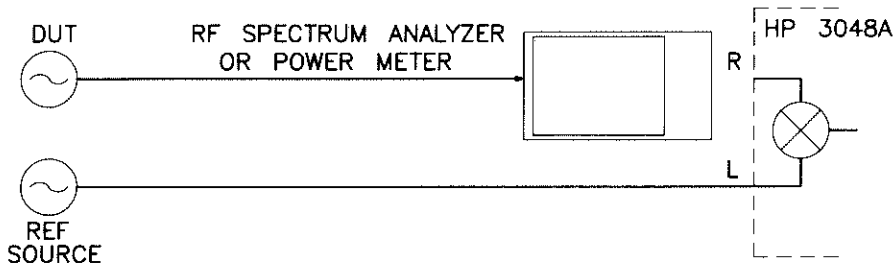

**Figure 2-12. R Port Power Setup Diagram**

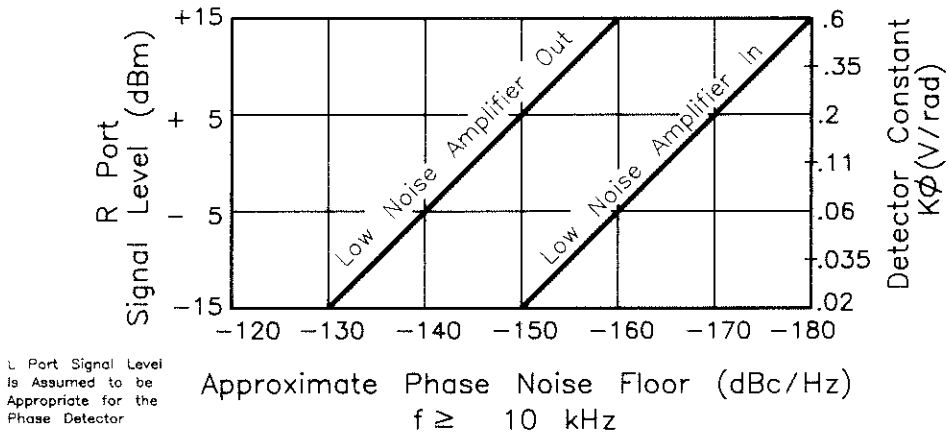

**Note:** This relationship assumes a 9 dB conversion loss in the Phase Detector.

**Figure 2-13. Estimate of Phase Detector Constant for a Given R Port Input Level**

The AUX MONITOR port on the HP 11848A Phase Noise Interface provides an output for monitoring the beatnote. Connecting an oscilloscope to this output port allows the Phase Detector Constant to be estimated from the peak amplitude of the beatnote. The peak voltage of the sine wave equals the Phase Detector Constant in V/Rad.

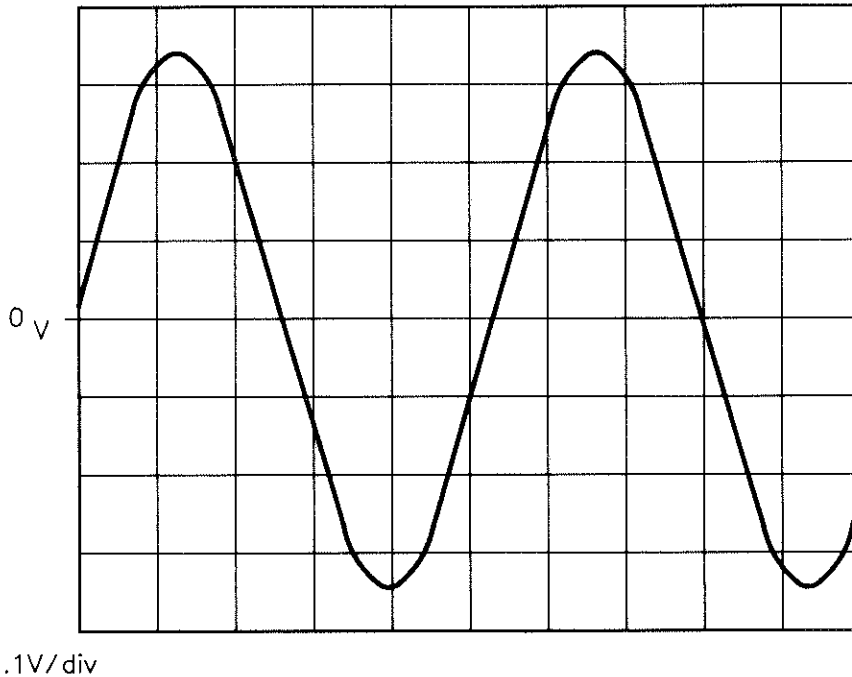

**Figure 2-14. Oscilloscope Display of Beatnote out of the HP 11848A Aux Monitor Port**

## Measure the Detector Constant

When “Measure the Detector Constant” is selected, the HP 3048A system automatically measures the Phase Detector Constant. Measuring the Phase Detector Constant is the most accurate method for calibrating the detector. The system calibrates the Phase Detector Constant by generating a beatnote frequency at approximately 10% of the entered Peak Tuning Range. The maximum Peak Tuning Range the system will accept is 500 kHz (or 200 MHz if a supported RF Analyzer is configured in the system).

If the beatnote is less than 1 kHz, the system measures the slope of the zero crossings to determine the Phase Detector Constant. If the beatnote is greater than or equal to 1 kHz, the system measures the amplitude of the fundamental of the beatnote signal and its odd harmonics to determine the Detector Constant.

$$\text{Detector Constant}_{<1 \text{ kHz}} = \text{Slope}_{\text{Beatnote}}$$

$$\text{Detector Constant}_{\geq 1 \text{ kHz}} = H_1 - 3H_3 + 5H_5 - 7H_7 \dots$$

where  $H_1 =$  Peak amplitude of fundamental of beatnote  
and  $H_n =$  Amplitude of harmonics of beatnote

## Considerations for the Phase Detector Constant

**The HP 11848A External Noise Input** must be attenuated as needed to limit the Phase Detector Constant to less than 1 V/Rad to keep from overloading the HP 11848A. The beatnote must be DC coupled to the input for the Phase Lock Loop to operate.

**Insufficient power at the L input port** on the HP 11848A can cause excessive conversion loss through the phase detector. In addition, the beatnote may be compressed causing an incorrect calibration of the Phase Detector Constant.

**The input level at the R input port** of the HP 11848A determines the system's sensitivity. Amplification of the input signal to the R port will increase the Phase Detector Constant thereby decreasing the system's noise floor.

**The Phase Detector Constant cannot be measured** if the system cannot generate a beatnote of less than 50 kHz (20 MHz for systems with an RF Analyzer), or if the sources are injection locking. Also, the system cannot measure the Phase Detector Constant if the beatnote deviates too much from a sine wave, or is excessively noisy. In these cases, you may need to enter the Phase Detector Constant using a power level estimate or from examination of the beatnote.

**If the beatnote is less than 1 kHz**, and the system cannot locate three zero-crossings within the time record of the HP 3561A Dynamic Signal Analyzer, the system cannot measure the Phase Detector Constant. In this case, you should abort the measurement, verify all of the entered parameters and initiate a New Measurement.

**The recommended range for the Phase Detector Constant** when making a phase lock loop measurement using the 5 MHz to 1.6 GHz Phase Detector is 20 mV to 1V. The recommended range when making a phase lock loop measurement using the 1.2 GHz to 18 GHz Phase Detector is 100 mV to 0.3V. Detector Constants down to 20 mV may work but, proper operation may be inhibited by dc offsets up to 50 mV.

**Adequate isolation** must be provided to insure that the injection locking range is much less than the Phase Lock Loop Bandwidth. Injection Locking removes or distorts the beatnote from which the Phase Detector Constant is measured.

**The sensitivity of the HP 11848A front panel meter** depends on the gain and attenuation settings within the phase lock circuitry. When the system is phase locked, 0 V (center scale) on the meter indicates that the sources are tuned to exactly the same frequency. The HP 3048A detects an out of lock indication when the meter moves off zero more than  $\pm 2.5$  divisions. The full scale meter voltage is determined from the sum of the Center Voltage of the VCO Tuning Curve (CV) and the Voltage Tuning Range of VCO (VTR) entered in the Instr Parameter Menu and the configuration of the HP 11848A's internal attenuator. The following table shows the four full scale meter voltages possible.

Full Scale Meter Voltage	Center Voltage (CV) Voltage Tuning Range (VTR)
1	$0.2V \leq CV + VTR \leq 1.2V$
2	$1.2V < CV + VTR \leq 2.4V$
5	$2.4V < CV + VTR \leq 6V$
10	$6V < CV + VTR \leq 12V$

**Spurs** on the input signals to the phase detector must be less than  $-26$  dBc at offsets greater than the PLL BW. At offsets within the PLL BW, spurs may increase at 20 dB per decade starting at  $-26$  dBc at the PLL BW.

**Harmonics** on the input signals to the phase detector must be less than  $-20$  dBc or harmonics of a square wave.

**Odd harmonics** on the beatnote out of the phase detector must be less than  $-10$  dBc and even harmonics must be less than  $-30$  dBc.

**Source Return Loss** less than 9.5 dB (2:1 SWR) may degrade the performance of the HP 3048A system.

# The VCO Tuning Constant

## Introduction

The VCO Tuning Constant is the frequency sensitivity of the VCO source to voltage changes at its control voltage input. This constant is measured in Hz/V. The HP 3048A uses the VCO Tuning Constant along with the defined Voltage Tuning Range and the VCO's Tuning Port Input Resistance to determine the Peak Tuning Range for the measurement. The Bandwidth of the Phase Lock Loop, the Lock Capture Range, and the Drift Tracking Range for the measurement are all derived from the Peak Tuning Range.

Three calibration methods are available for determining the VCO Tuning Constant for the measurement; Measure the VCO Tuning Constant, Use the Current Tuning Constant, and Compute from the expected Tuning Constant. The system uses the method displayed in inverse video on the computer screen. To change the method, press the **Tuning Const** softkey. The following table lists tuning characteristics of various VCO source options.

VCO Source	Carrier Freq.	Tuning Constant (Hz/V)	Center Voltage (V)	Voltage Tuning Range ( $\pm$ V)	Input Resistance (ohms)	Tuning Calibration Method
HP 8662/3A EFC DCFM	$\nu_o$	5 E - 9 $\times$ $\nu_o$	0	10	1 E + 6 1k (8662) 600 (8663)	Measure Compute Compute
		FM Deviation	0	10		
HP 8642A/B		FM Deviation	0	10	600	Compute
HP 8640B		FM Deviation	0	10	600	Compute
HP 8656B		FM Deviation	0	10	600	Compute
Other Signal Generator DCFM Calibrated for $\pm$ 1V		FM Deviation	0	10	$R_{in}$	Compute
10 MHz Source A Direct Multiplied As a Timebase: To HP 8662/3A To other synthesized signal generators	$\nu_o$	10	0	10	1 E + 6	Measure
		1 E - 6 $\times$ $\nu_o$	0	10	1 E + 6	
	$\nu_o$	1 E - 6 $\times$ $\nu_o$	0	10 E + 9 $\div$ $\nu_o$	1 E + 6	
	$\nu_o$	1 E - 6 $\times$ $\nu_o$	0	1 E + 6 $\times$ PTR* $\div$ $\nu_o$	1 E + 6	
10 MHz Source B Direct Multiplied As a Timebase: To HP 8662/3A  To other synthesized signal generators	$\nu_o$	100	0	10	1 E + 6	Measure
		10 E - 6 $\times$ $\nu_o$	0	10	1 E + 6	
	$\nu_o$	10 E - 6 $\times$ $\nu_o$	0	1 E + 9 $\div$ $\nu_o$ , (up to 2.5V max.)	1 E + 6	
	$\nu_o$	10 E - 6 $\times$ $\nu_o$		100 E + 3 $\times$ PTR* $\div$ $\nu_o$	1 E + 6	
350-500 MHz Source		12 E + 6	0	2	1 E + 6	Measure
Other User VCO Source		Estimated within a factor of 2	-10 to +10	See Graph 8	1 E + 6	Measure

\* Limited PTR due to PLL BW limitations

## Parameter Entry Descriptions

### Use the Current Tuning Constant

This calibration method uses the value of the Tuning Constant currently in memory. Selecting this method can save the time of measuring the Tuning Constant without any degradation in accuracy, providing either the same VCO source is being used or a source with an identical Tuning Constant is being used (within  $\pm 5\%$ ).

### Measure the VCO Tuning Constant

Selecting this calibration method causes the system to automatically measure the tuning sensitivity and tuning linearity of the VCO source. Measuring the Tuning Constant is the recommended method under most circumstances for ensuring measurement accuracy. (As noted below, the special case of extending the VCO Tuning Voltage Range requires selection of the Compute from Expected T. Constant calibration method.) The system cannot measure the Tuning Constant for an entered Peak Tuning Range greater than 500 kHz for systems configured without an RF Analyzer, and 200 MHz for systems configured with an RF Analyzer.

When measuring the VCO Tuning Constant, the system requires that the VCO Tuning Constant defined in the Instrument Parameter display be within a factor of two of the VCO's actual sensitivity. This approximation is required in order for the HP 3048A to establish a beatnote. The frequency response of the VCO source must remain flat ( $\pm 0.3$  dB) from dc to the phase lock loop bandwidth (PLL BW).



**Extending the VCO Tuning Voltage Range** value as defined on the Instrument Parameters display to 10V is a valid way to increase the Peak Tuning Range for the measurement. The VCO source being used in this case must be a signal generator with a calibrated DC FM Input (such as the HP 8662A). When the tuning range has been extended, select the “Compute from Expected T. Constant” calibration method for the measurement. Refer to the “Enhanced Tuning Range” description in *Instrument Parameters* in this chapter for complete details on extending the VCO Voltage Tuning Range.

### **Compute from Expected T. Constant**

Selecting the Compute from Expected Tuning Constant method causes the system to use the entered VCO Tuning Constant and Tune-port Input Resistance that have been defined on the Instrument Parameter display. This method requires that the entered VCO Tuning Constant is within  $\pm 5\%$  of the VCO’s actual sensitivity. If it is not, the system will report an Accuracy Specification Degradation after verifying the Phase Lock Loop Suppression.

$$VCO\ Tuning\ Constant = Entered\ VCO\ Tuning\ Constant \times \frac{R_{in}}{R_{in} + 50}$$

Where :  $R_{in}$  = VCO Tune Port Input Resistance

## Consideration for the VCO Tuning Constant

The VCO's tuning curve must be within the parameters shown in the following graph.

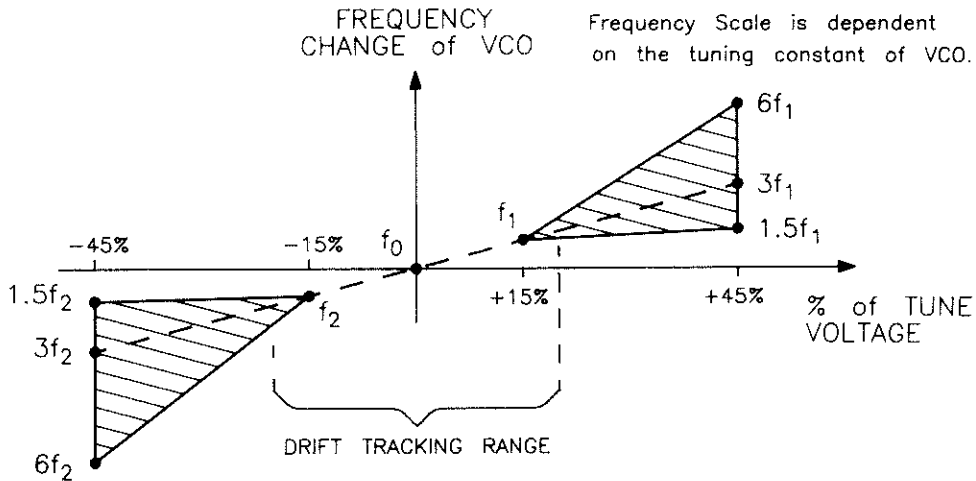

Figure 2-15. VCO Tuning Response Linearity Requirements of the HP 3048A

When the VCO Tuning Linearity does not meet the requirements of Figure 2-15, an ERROR message is generated to inform you that the system cannot continue. If this happens, you must do one of the following:

- Inspect the 4 points to determine the source of the non-linearity (disconnected tune line, drift, wrong DC FM sensitivity, wrong voltage tune range).
- Restrict the Tuning Range to a portion of the Tuning Curve which is linear.
- Replace the VCO with one having a linear Tuning Constant, or
- Instruct the system not to measure the Tuning Constant.

# The Loop Suppression Verification

## Introduction

Verification of the Phase Lock Loop Suppression insures that the Phase Lock Loop Bandwidth (PLL BW), the Phase Detector Constant, and the VCO Tuning Constant are all accurate for the measurement. (Note that the HP 3048A always corrects for the loop suppression whether verification is selected or not.)

## Description

The HP 3048A verifies Loop Suppression before beginning the measurement by closing the phase lock loop and injecting noise into the loop. The response of the loop is measured and recorded. The loop is then opened, and a measurement is made of the open loop response. The suppression of the PLL is the difference between the closed loop response and open loop response to the injected noise. The measured Loop Suppression curve is smoothed and then four points are selected along the curve including the peak and the  $-8$  dB point. The measured curve is then compared to the theoretical curve at the four selected points. Figure 2-16 shows an example of a Loop Suppression curve measured by the HP 3048A. (For information about displaying and interpreting the curve, and using the 11848A Control softkey for troubleshooting this measurement, refer to *Test Mode* in Chapter 5 Special Functions.

The amount of adjustment required to fit the theoretical curve to the measured curve is recorded as the PLL GAIN CHANGE on the Suppression Graph and the frequency of the Assumed Pole. The Assumed Pole is a software controlled term used to fit the Adjusted Theoretical loop response to the smoothed measured response of the phase lock loop. The MAX ERROR is the final amount of error existing between the adjusted theoretical curve and the measured curve of the phase lock loop suppression. If the PLL GAIN CHANGE or MAX ERROR is greater than 1 dB, the System

Specification Degradation has been detected. (For information about the appropriate actions to take when Reference Message 12 appears, please refer to Chapter 8 Messages.)

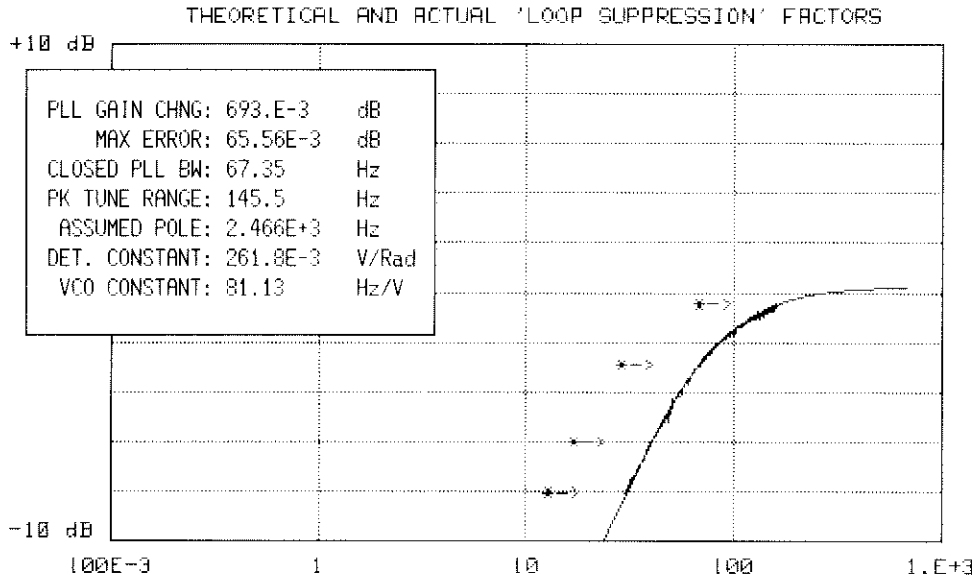

**Figure 2-16. Example of Loop Suppression Graph**

## Considerations for the Loop Suppression Verification

Verification of the loop suppression may be prevented by excessive noise close to the carrier, by a large spur within the bandwidth of the PLL, or by injection locking.

It should be assumed that an indicated Accuracy Specification Degradation applies at all offset frequencies (both inside and outside of the loop bandwidth).

If the Detector Constant and VCO Tune Constant are known to be accurate, the PTR is less than 10 MHz, and the VCO tuning port bandwidth is less than  $PLL\ BW \times 10$ , then a measurement without Loop Suppression Verification will be accurate.

# Calibration for the Phase Noise Without Using a PLL Measurement

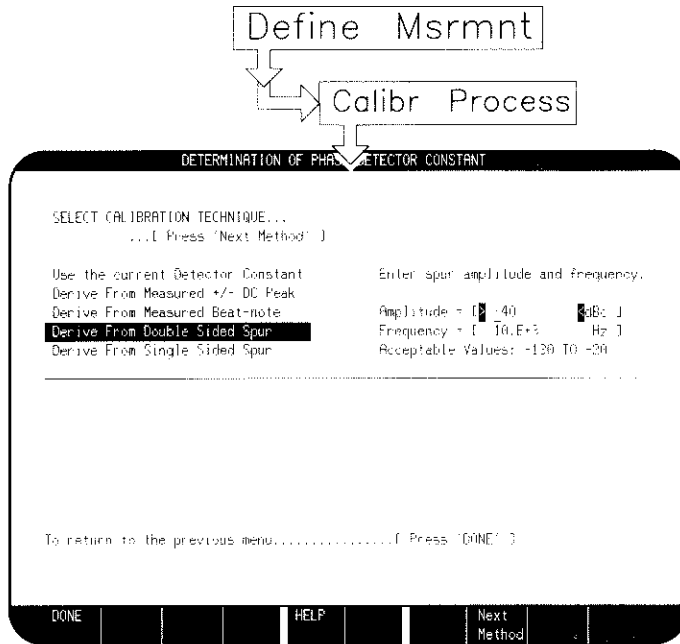

## Introduction

Calibration of the “Phase Noise Without Using a PLL” measurement type involves calibration of the Phase Detector Constant. The Phase Detector Constant is the sensitivity of the phase detector expressed in V/Rad. The noise floor (or the maximum sensitivity of the system) is set by the Phase Detector Constant.

The phase detector translates phase fluctuations to voltage fluctuations. The amplitude of the phase detector’s voltage output is proportional to the phase fluctuations at its input and its sensitivity. The detector’s sensitivity is a function of the power levels at its input. The Phase Detector Constant determines the absolute noise floor of the system.

There are several methods available for calibrating the Phase Detector Constant when phase noise measurements are made without using a phase lock loop. The primary considerations for selecting a calibration method are measurement accuracy and equipment availability.

Technique	Additional Equipment Required	Accuracy
Use the Current Detector Constant	None	*
Derive From Measured $\pm$ DC Peak	Phase Shifter or source with appropriate frequency resolution	Fair
Derive From Measured Beat-note	Second RF source	Good
Derive From Double Sided Spur	Phase Modulator, Audio Source, and RF Analyzer	Best
Derive From Single Sided Spur	Directional Coupler, RF Analyzer, and Second RF Source	Best
* Accuracy depends on which technique was used to determine the Detector Constant in memory.		

# Use the Current Detector Constant

## Introduction

This calibration method configures the system to use the Phase Detector Constant currently in memory. This eliminates the time spent calibrating the Phase Detector Constant. The Phase Detector Constant in memory is the value that was determined by the last measurement made (unless a stored Test File has been loaded). The Phase Detector Constant value appears in the Calibration Process display.

The Phase Detector Constant is valid for repeat measurements of similar devices as long as the input power levels remain the same (within  $\pm 0.3$  dB).

## Parameter Entry Descriptions

### Entering a Detector Constant

The Phase Detector Constant's value may be changed by keying in the desired value when "Use the Current Detector Constant Method" is displayed in inverse video. The Acceptable Limits for the Phase Detector Constant are shown on the display. (Keep in mind that absolute measurement accuracy depends on the accuracy of the Phase Detector Constant.)

### Estimating a Detector Constant

An estimate of the Phase Detector Constant can be made directly from the R port input power level. (Providing the power level requirements for driving the L port of the phase detector are being met.) A power meter or a spectrum analyzer can be used to measure the power level. Compare the measured R port level to the following graph to determine the Phase Detector Constant.



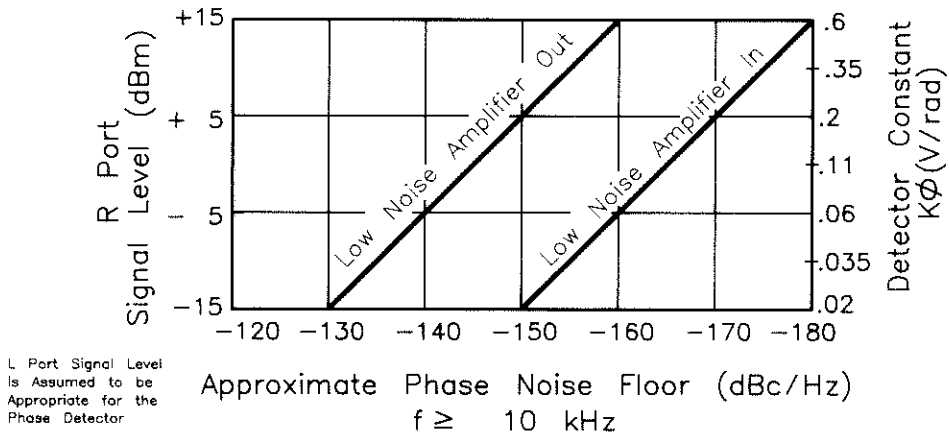

**Figure 2-17. Relationship between Phase Detector Constant and R Port Level**

## Considerations When Using the Current Detector Constant

User entry is potentially the least accurate method for determine the Detector Constant.

This calibration method does not verify the accuracy of the Phase Detector Constant. It relies strictly on the user to ensure the validity of the Detector Constant being used. (Keep in mind that the accuracy of the Detector Constant relates directly to the accuracy of the measurement. A Detector Constant accurate to within  $\pm 1$  dB will guarantee a measurement accuracy of  $\pm 2$  dB.)

An accuracy degradation may be acceptable when only the relative shape of a device's noise characteristics is important rather than the absolute noise level. In this case, only a crude approximation of the Phase Detector Constant is necessary.

# Derive From Measured +/- DC Peak

## Introduction

The Derive From Measured +/- DC Peak selection configures the system to measure the positive and negative peak voltages out of the phase detector. The measured +/- DC Peak voltages out of the phase detector are averaged to determine the Phase Detector Constant (Peak volts = Detector Constant in V/Rad.)

This method requires a phase shifter, or an RF source capable of tuning the phase detector through 360° of phase shift to achieve the maximum and minimum dc voltages. The system will prompt you to adjust the phase. One of the advantages of using this method of calibration is that the phase detector is calibrated using the same equipment used for the measurement. Manual operation of the equipment may be required, however.

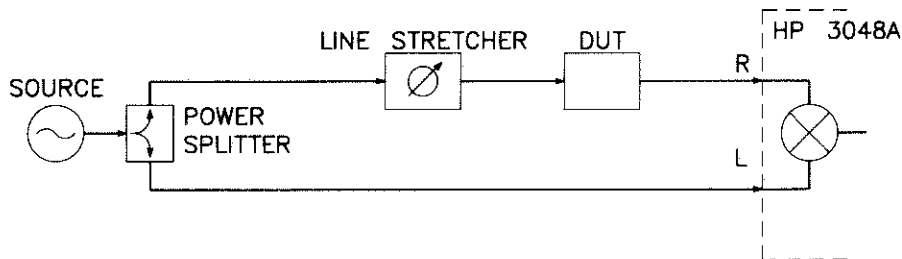

Figure 2-18. +/- DC Peak Setup Diagram

## **Considerations for the Derive From Measured +/- DC Peak Method**

This method for determining the Phase Detector Constant provides more accuracy than an estimated entry but less than the Beatnote, Double Sided Spur, or Single Sided Spur methods.

The accuracy of the Phase Detector Constant using this method depends upon the power level driving the phase detector. The phase detector should be operated in its linear region for best accuracy. Very high input levels are often used to maximize the system's noise floor at the expense of driving the Phase Detector in its non-linear region. The HP 3048A assumes the phase detector is operating in its linear region during calibration. If the Phase Detector is operating in its non-linear region, the Detector Constant could be slightly in error (maximum error is  $\approx 1$  dB).

# Derive From Measured Beat-Note

## Introduction

The beatnote method for calibrating the Phase Detector Constant requires two signal sources. Usually one source is used only for calibration. The calibration source is connected to the phase detector in place of one of the input signal paths. The output level of the calibration source must be adjusted to provide exactly the same signal level at the phase detector input port as will be present during the measurement. The disconnected signal path should be terminated in 50 ohms to maintain the power level at the other input port of the phase detector.

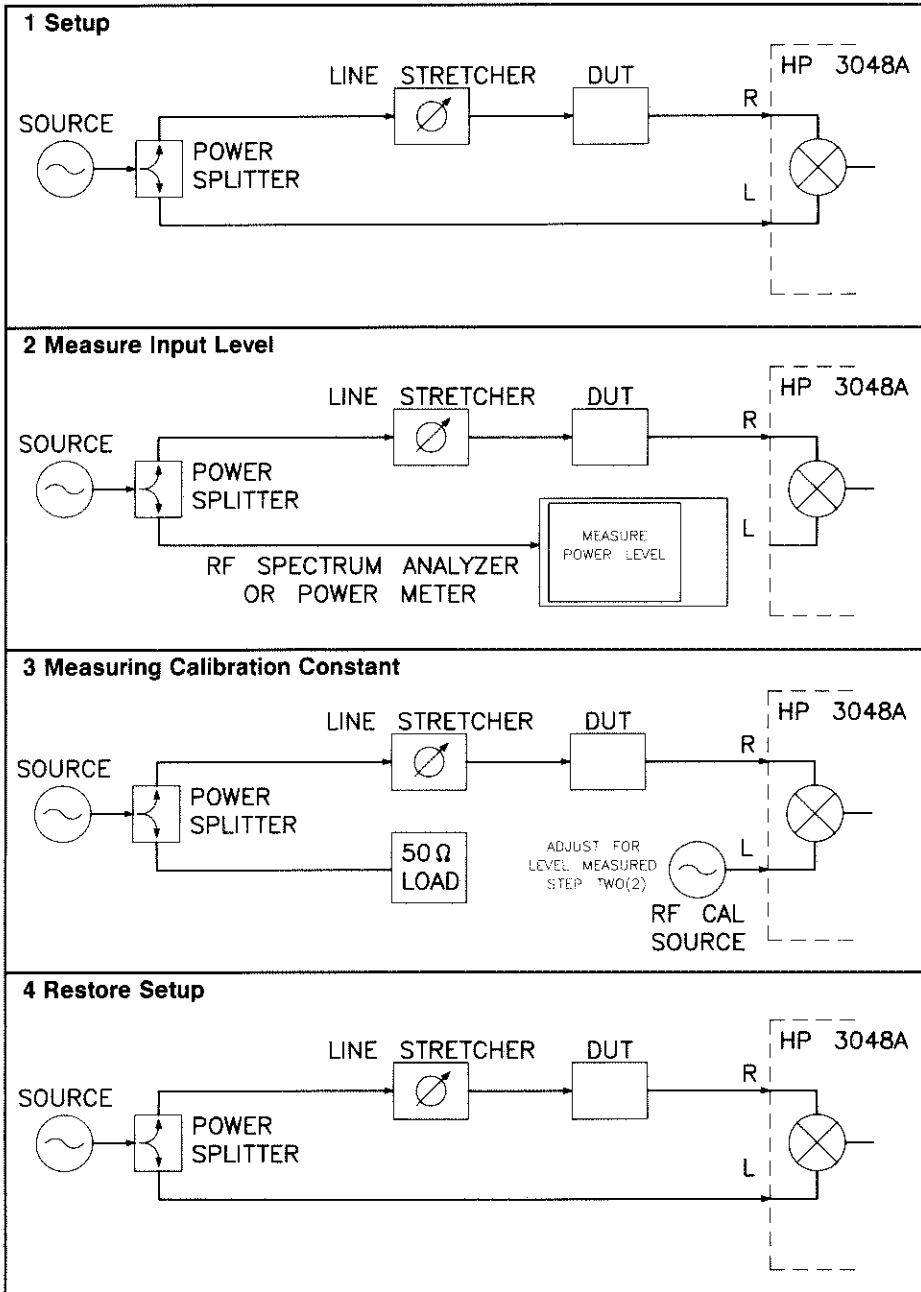

Figure 2-19. Setup Block Diagram for Beat-Note Calibration

## **Description of the Beatnote Calibration Method**

### **Beatnote Frequencies Less Than 1 kHz**

To determine the Phase Detector Constant from a beatnote, the calibration source is adjusted to create a beatnote between the two sources. For beatnote frequencies less than 1 kHz the system uses the slope of the beatnote waveform as it passes through the zero crossing as the Phase Detector Constant (or sensitivity of the detector to variations in phase). If slope of the beatnote waveform differs by less than 10% on two consecutive zero crossings, as in a sine wave or a triangle wave, then the system's ability to determine the Phase Detector Constant is very good. The Phase Detector Constant is valid for variations in phase up to 0.2 radians (the small angle criteria).

### **Beatnote Frequencies Greater than 1 kHz**

Beatnotes greater than 1 kHz require that the system determine the Phase Detector Constant by measuring the beatnote fundamental and its odd harmonics. The odd harmonics of the beatnote are measured to determine how much the beatnote departs from a sine wave. This measurement corrects the measured amplitude of the beatnote to determine an accurate Phase Detector Constant for non-sinusoidal beatnotes.

If the first odd harmonic is less than  $-30$  dBc, the system assumes the beatnote is a sine wave. The Phase Detector Constant is a function of the amplitude of the fundamental (a sine wave's peak amplitude is equal to the phase slope). If, however, the first odd harmonic of the beatnote is greater in amplitude than  $-30$  dBc but beyond the range of the analyzer configured in the system, the system will incorrectly assume that the beatnote is a sine wave. In this case, a small error in the Detector Constant is introduced (maximum, worst case error is  $\approx 1$  dB). For this reason, the beatnote frequency should be less than one third of the full scale frequency range of the system analyzer. (As an example, the HP 3561A has a maximum frequency span of 100 kHz, therefore, a beatnote frequency

of less than 30 kHz will insure that the third harmonic (90 kHz) can be measured.)

### **Considerations for the Derive from Measured Beat-Note Method**

This method is more accurate than the  $+/-$  DC Peak method but not as accurate as the single or double sided spur method. The level of the calibration source and the circuit it replaces must be exactly the same or the Detector Constant will be in error.

The HP 3048A displays messages that guide you through the manual steps required for the Beatnote Calibration method.

Since the peak voltage of a sine wave is equal to its slope, the peak voltage can be used as an approximation of the Phase Detector Constant for sinusoidal beatnotes. The beatnote can be examined with an oscilloscope using the HP 11848A AUX MONITOR port. This is helpful to confirm that the Phase Detector Constant measured by the system is correct.

# Derive From Double Sided Spur

## Introduction

The Derive From Double Sided Spur method is one of the most accurate Detector Constant Calibration methods available. However, it requires additional equipment and presents a high level of technical difficulty.

This calibration method requires the generation of modulation sidebands. The sideband (spur) level relative to the carrier level (dBc) and the spur offset frequency must be determined first using an RF spectrum analyzer or modulation analyzer. You will be required to define the relative level and offset frequency values in the Calibration Process display either during the measurement definition or when you reach the Connect Diagram.

The system measures the phase detector output for the known spur levels and calculates the Phase Detector Constant.



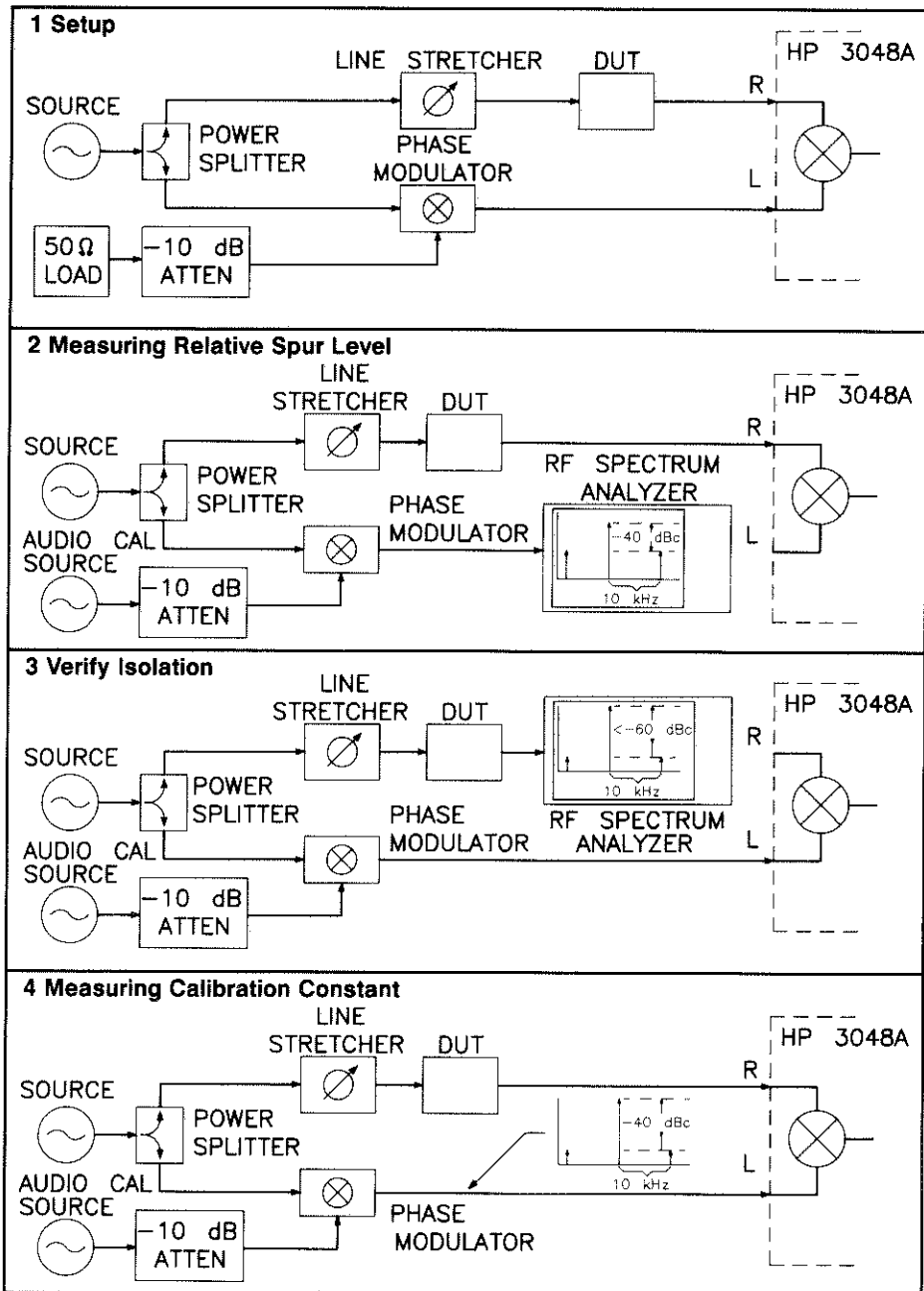

Figure 2-20. Setup Block Diagram for Double Sided Spur Calibration

## Description of the Double Sided Spur Calibration Method

An RF spectrum analyzer is required to measure the relative difference between the fundamental signal and the spur. A spur level of  $-20$  to  $-130$  dBc is acceptable, however, levels within the range  $-26$  to  $-60$  dBc are optimum. The calibration spur can be set at a frequency offset of 1 Hz to 100 kHz (40 MHz with a supported RF analyzer) however 20 Hz to 50 kHz is recommended.

A modulation analyzer with phase demodulation capability can be used in place of the RF Analyzer. In this case the sideband levels can be determined with the following formula.

$$\text{Sideband Level in dBc} = 20 \log_{10} \frac{\text{Peak Phase Deviation}}{2}$$

---

### NOTE

It is important to insure that the level of the calibration spurs are greater than the level of any other spurious signals present in the frequency spectrum. Also, you should evaluate both sideband calibration spurs to ensure that they are equal in amplitude. (Any deviation in the amplitude of the calibration spurs indicates the presence of AM in the phase modulator.) Modulation Analyzers reject the AM contribution to the sidebands thus removing any inaccuracies due to AM.

---

Ensure that there is at least 20 dB of isolation between the drive circuit to the R input port and the L input port of the Phase Detector by measuring the level of the spur at both input ports. (Less than 20 dB of isolation will cause the calibration spur to be correlated out by the phase detector.)

When the Connect Diagram appears, the Calibr Process softkey will provide access to the the Determination of Phase Detector Constant display (Calibr Process) where the calibration spur values can be entered.

When the system measures the calibration spur, the analyzer does a peak search over a frequency span of two times the entered spur offset frequency. Once the spur has been located, the level of the spur is measured and used to compute the Phase Detector Constant. This method compensates for both the non-linearity and harmonics of the phase detector.

## **Considerations for the Derive From Double Sided Spur Method**

Requires an RF Spectrum Analyzer capable of measuring the carrier frequency and the modulation side bands or a modulation analyzer with phase demodulation capabilities.

Requires a Phase Modulator capable of generating the calibration spurs at the desired carrier frequency.

Evaluation of the modulated spurs are necessary to insure good accuracy. Uneven sidebands denote amplitude modulation.

At least 20 dB of isolation is required through the power splitter between the R port and the L port of the phase detector to prevent the calibration spurs from being correlated out.

# Derive From Single Sided Spur

## Introduction

The Derive From Single Sided Spur method is a very accurate method for calibrating the Detector Constant. However, it requires additional equipment and presents a high level of technical difficulty.

This calibration method requires that an additional signal (representing the spur) is applied to one of the phase detector inputs. The sideband (spur) level relative to the carrier level (dBc) and the spur offset frequency must first be determined using an RF spectrum analyzer. You will be required to enter the relative level and offset frequency values in the Calibration Process display either during measurement definition or when you reach the Connect Diagram.

The system measures the phase detector output for the known spur levels and calculates the Phase Detector Constant.

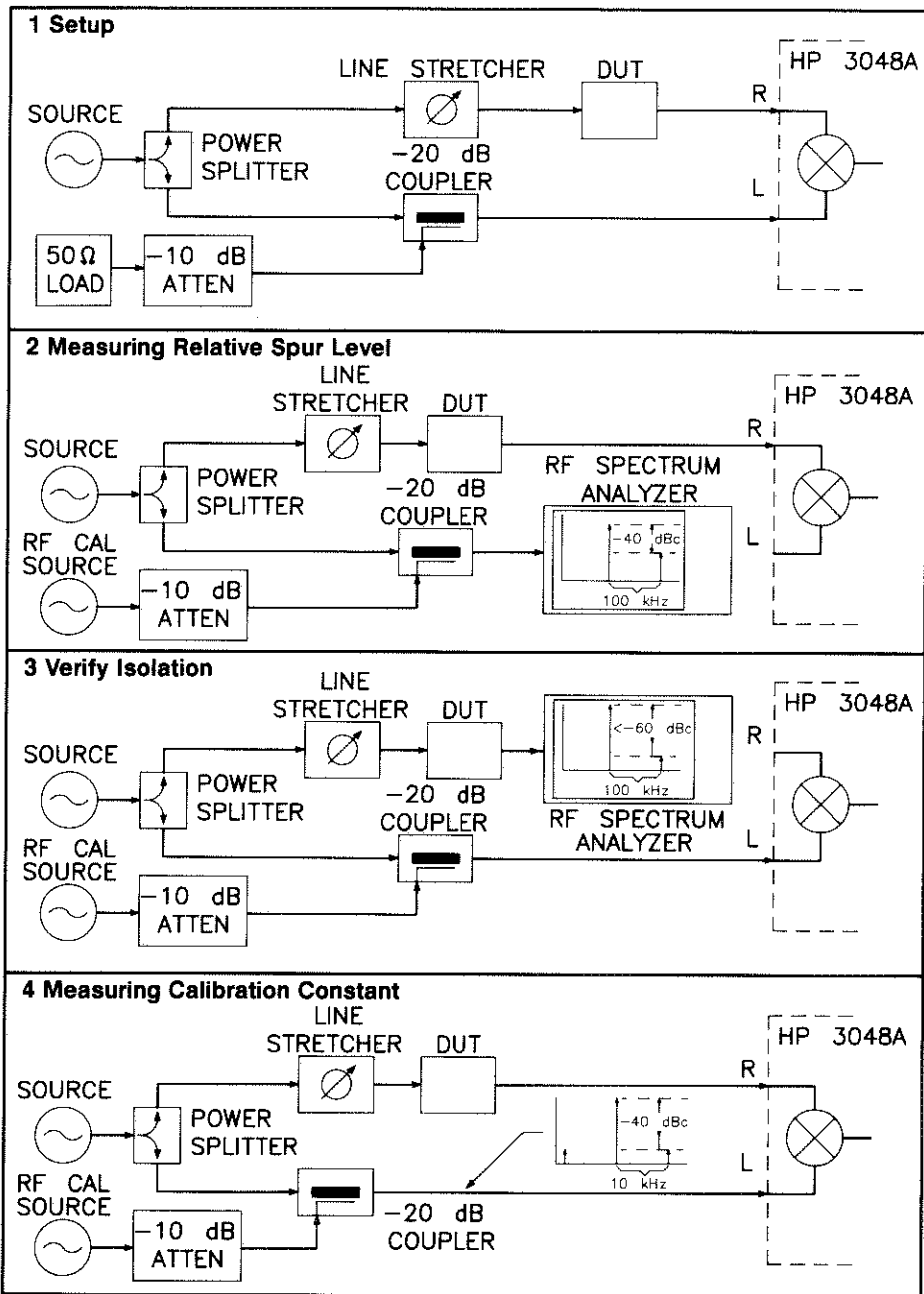

Figure 2-21. Setup Block Diagram for the Single-Sided Spur Calibration Method

## Description of the Single Sided Spur Calibration Method

A second RF signal generator and a directional coupler are required to inject the calibration spur. The calibration spur should be adjusted to approximately  $-40$  dBc at an offset frequency that can be accurately measured with the RF analyzer. A spur level of  $-20$  to  $-130$  dBc is acceptable, however, levels within the range  $-26$  to  $-60$  dBc are optimum. The calibration spur can be set at a frequency offset of 1 Hz to 100 kHz (40 MHz with a supported RF analyzer) however 20 Hz to 50 kHz is recommended.

---

### NOTE

It is important to insure that the level of the calibration spur is greater than any other spurious signals present in the frequency spectrum. When the system measures the calibration spur, the analyzer does a peak search over a frequency span of two times the entered spur frequency.

---

Ensure that there is at least 20 dB of isolation between the drive circuit to the R input port and the L input port of the Phase Detector by measuring the level of the spur at both input ports. (Less than 20 dB of isolation will cause the calibration spur to be correlated out by the phase detector.)

When the Connect Diagram appears, the Calibr Process softkey will provide access to the the Determination of Phase Detector Constant display (Calibr Process) where the calibration spur values can be entered.

When the system measures the calibration spur, the analyzer does a peak search over a frequency span of two times the entered spur offset frequency. Once the spur has been located, the level of the spur is measured and used to calculate the Phase Detector Constant. This method compensates for both the non-linearity and harmonics of the phase detector. (The HP 3048A will inform you when to remove the calibration spurs.)

## **Considerations for the Derive From Single-Sided Spur Method**

Requires a RF Spectrum Analyzer capable of measuring the calibration spur at the desired carrier frequency.

Calibration is performed under actual measurement setup conditions.

The non-linearity and harmonics of the phase detector are calibrated out.

The relative level (dBc) of the calibration spur must remain the same when the system measures the amplitude of the spur as when the reference measurement was made using the RF analyzer or modulation analyzer.

# Calibration for the FM Discriminator Measurement

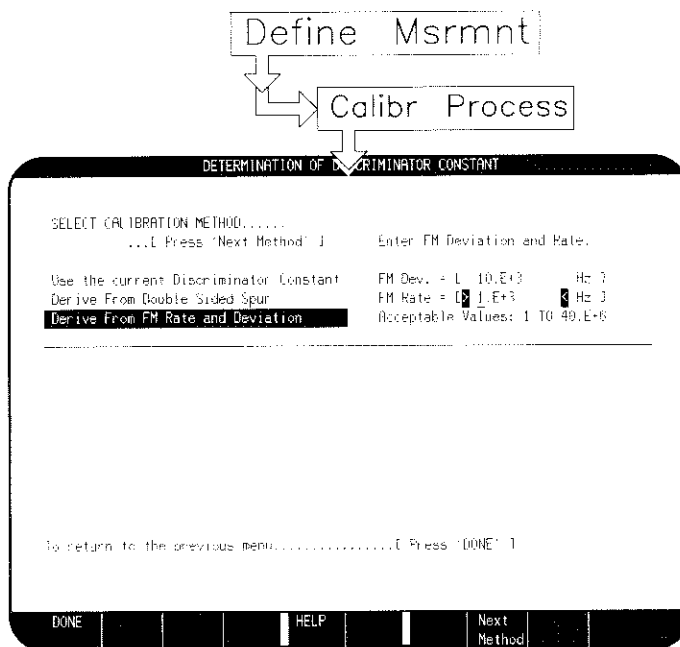

## Introduction

Phase Noise Measurements using an FM Discriminator require the calibration of the Discriminator Constant in V/Hz. The Discriminator Constant is the sensitivity of the discriminator to frequency fluctuations.

The HP 3048A Phase Noise Measurement System offers three methods for determining the Discriminator Constant. The primary considerations for selecting a calibration method are measurement accuracy and equipment availability.



---

## NOTE

The context of this calibration process applies directly to a delay line FM discriminator. These calibration processes will also apply to other types of FM discriminators.

---

The FM Discriminator translates the phase fluctuations into frequency fluctuations. Adjustment of the input frequency or a phase shifter is required to achieve quadrature. The Discriminator Constant determines the system's absolute noise floor for the measurements.

Technique	Additional Equipment Required	Accuracy
Use the current Discriminator Constant	None	*
Derive From Double-Sided Spur	FM or phase modulation Generator set at the carrier frequency	Excellent
Derive From FM Rate and Deviation	FM Generator set at the carrier frequency (can be at the IF frequency if a Down Converter is being used)	Excellent
* The accuracy is dependent on which technique was used to determine the Detector Constant currently in memory or the constant being entered.		

# Use the Current Discriminator Constant

## Introduction

This calibration method configures the system to use the Discriminator Constant currently in memory. This eliminates the time spent calibrating the Discriminator Constant. The Discriminator Constant in memory is the value that was determined by the last measurement made (unless a stored Test File has been loaded). The Discriminator Constant value appears in the Calibration Process display.

The Discriminator Constant is valid for repeat measurements of similar devices as long as the delay and the input power levels remain the same (within  $\pm 0.3$  dB).

## Parameter Entry Descriptions

### Entering a Discriminator Constant Value

The Discriminator Constant's value may be changed by keying in the desired value. The Acceptable Limits for the Discriminator Constant are shown on the display. (Keep in mind that absolute measurement accuracy depends on the accuracy of the Discriminator Constant.)

## Estimating the Discriminator Constant

The Phase Detector Constant can be estimated directly from the R port input power level. (Providing the power level requirements for driving the L port of the phase detector are being met.) A power meter or a spectrum analyzer can be used to measure the power level. Compare the measured R port level to the following graph to determine the Phase Detector Constant.

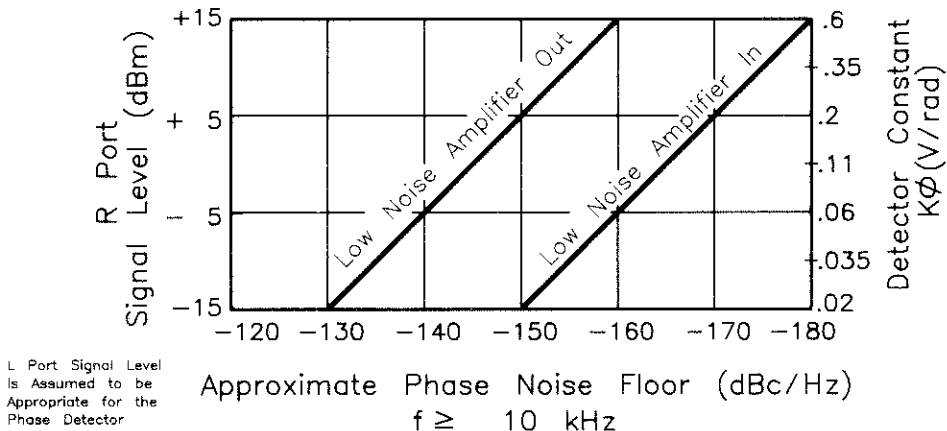

**Note:** This relationship assumes a 9 dB conversion loss in the Phase Detector.

**Figure 2-22. Estimate of Phase Detector Constant for a Given R Port Input Level**

An estimate of the Discriminator Constant ( $K_D$ ) can be derived from an estimate of the Phase Detector Constant ( $K_\phi$ ).

The following equation converts the Phase Detector Constant ( $K_\phi$ ) to a Discriminator Constant ( $K_D$ ).

$$K_D = 2\pi\tau K_\phi$$

where  $K_\phi$  = Detector Constant

$K_D$  = Discriminator Constant, and

$\tau$  = the delay of the discriminator

## Considerations When Using the Current Discriminator Constant

User entry is potentially the least accurate method for determining the Discriminator Constant.

This calibration method does not verify the accuracy of the Discriminator Constant. It relies strictly on the user to ensure the validity of the constant being used. (Keep in mind that the accuracy of the Discriminator Constant relates directly to the accuracy of the measurement. A Discriminator Constant accurate to within  $\pm 1$  dB will guarantee a measurement accuracy of  $\pm 2$  dB.)

An accuracy degradation may be acceptable when only the relative shape of a device's noise characteristics is important rather than the absolute noise level. In this case, only a crude approximation of the Discriminator Constant is necessary.

The Discriminator Constant calibration of the delay line discriminator is valid only to  $\frac{1}{2\pi\tau}$ .

# Derive From Double Sided Spur

## Introduction

The Derive From Double Sided Spur method is one of the most accurate Discriminator Constant Calibration methods available for determining the Discriminator Constant. However, it requires additional equipment and presents a high level of technical difficulty.

This calibration method requires the generation of modulation sidebands. The sideband (spur) level relative to the carrier level (dBc) and the spur offset frequency must first be determined using an RF spectrum analyzer. You must enter the relative level and offset frequency values either in the Calibration Process display or when the Connect Diagram appears.

The HP 3048A measures the spur level at the output of the discriminator (Phase Detector) and calculates the Discriminator Constant.

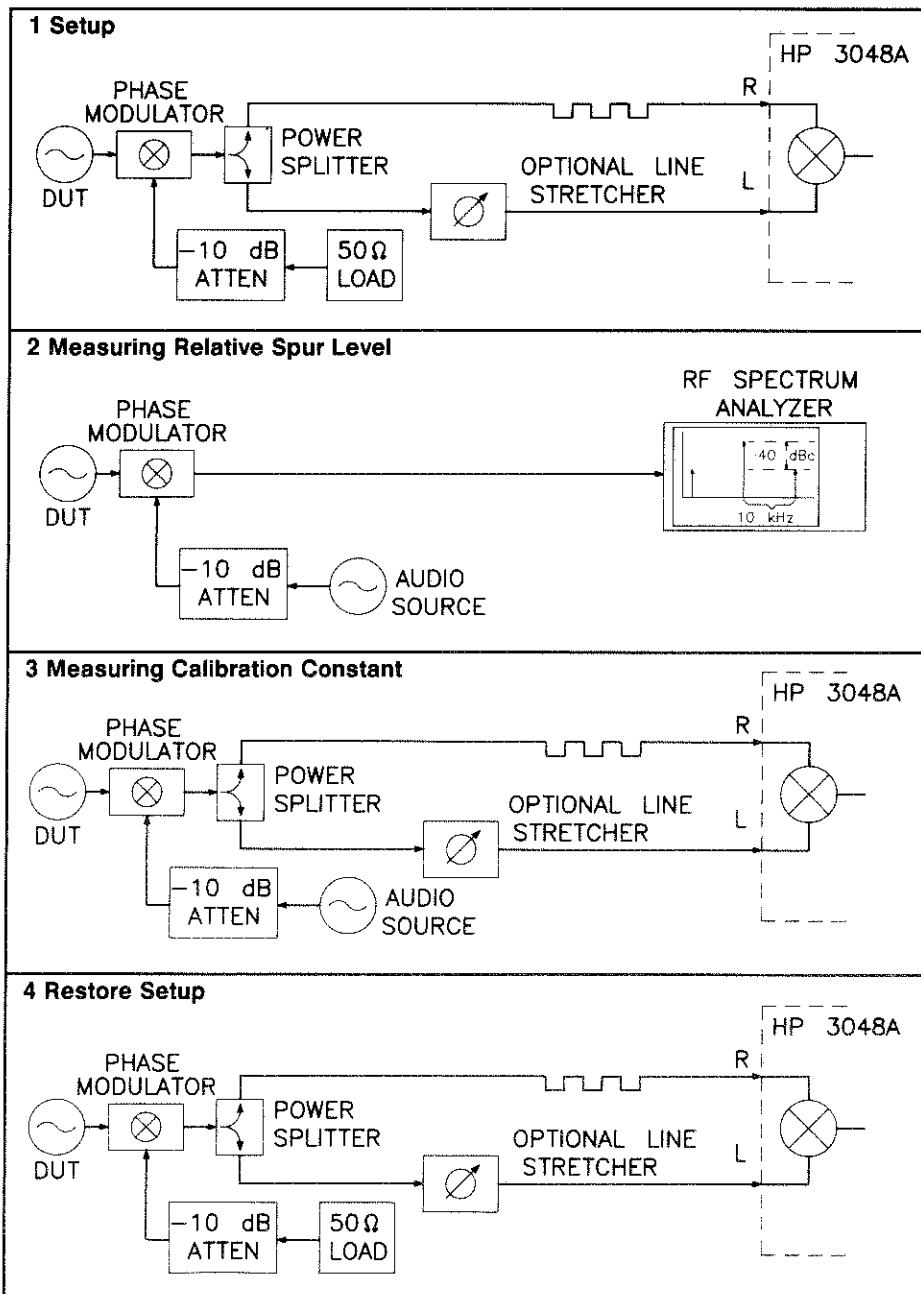

Figure 2-23. Setup Block Diagram for Double Sided Spur Calibration

## Description of the Double Sided Spur Discriminator Constant Calibration Method

An RF spectrum analyzer is required to measure the relative difference between the fundamental signal and the spur. A spur level of  $-20$  to  $-130$  dBc is acceptable, however, levels within the range  $-26$  to  $-60$  dBc are optimum. The calibration spur should be adjusted to an offset frequency (FM rate) that can be accurately measured by the RF analyzer or modulation analyzer. A recommended rate of less than  $\frac{1}{10\tau}$  will insure that the spur is within the flat response region of the discriminator's frequency response.

---

### NOTE

It is important to insure that the level of the calibration spurs are greater than the level of any other spurious signals present in the frequency spectrum. Also, you should evaluate both sideband calibration spurs to ensure that they are equal in amplitude. (Any deviation in the amplitude of the calibration spurs indicates the presence of AM in the phase modulator.) Modulation Analyzers reject the AM contribution to the sidebands thus removing any inaccuracies due to AM.

---

The calibration spur value can be entered either during the measurement definition process when the Calibration Process display is accessed, or they can be entered when the Connect Diagram is accessed. When the Connect Diagram appears, the Calibr Process softkey will provide access to the Determination of Phase Detector Constant display where the calibration spur values can be entered.

When the system measures the calibration spur, the analyzer does a peak search over a frequency span of two times the entered spur offset frequency. Once the spur has been located, the level of the spur is

measured and used to calculate the Discriminator Constant. This method compensates for both the non-linearity and harmonics of the phase detector.

## **Considerations for the Derive From Double Sided Spur Method**

Requires an RF Spectrum Analyzer capable of measuring the carrier frequency and the modulation side bands or a modulation analyzer with phase demodulation capabilities.

Requires a Phase Modulator capable of generating the calibration spurs at the desired carrier frequency.

Evaluation of the modulated spurs are necessary to insure good accuracy. Uneven sidebands denote amplitude modulation.

The HP 11848A's front-panel meter can be used as an aid for adjusting normal quadrature. The meter has a full scale sensitivity of 20 mV with a 2 mV/Div resolution. The meter reading setting must be within  $\pm 1$  division of center scale for starting a measurement and must remain within  $\pm 2$  divisions of the center during the measurement.

An FM rate that is greater than  $\frac{1}{2\pi\tau}$  will result in a calibration spur that is beyond the flat region of the Discriminator frequency response.



# Derive From FM Rate and Deviation

## Introduction

The FM Rate and Deviation method is very accurate and is the only fully automated method for determining the Discriminator Constant. This calibration method requires the application of a frequency modulated signal to the measurement configuration. The FM rate and deviation must be determined. You will be required to define these values either in the Calibration Process display or when the Connect Diagram appears.

The HP 3048A measures the spur level at the output of the discriminator (Phase Detector) and calculates the Discriminator Constant.

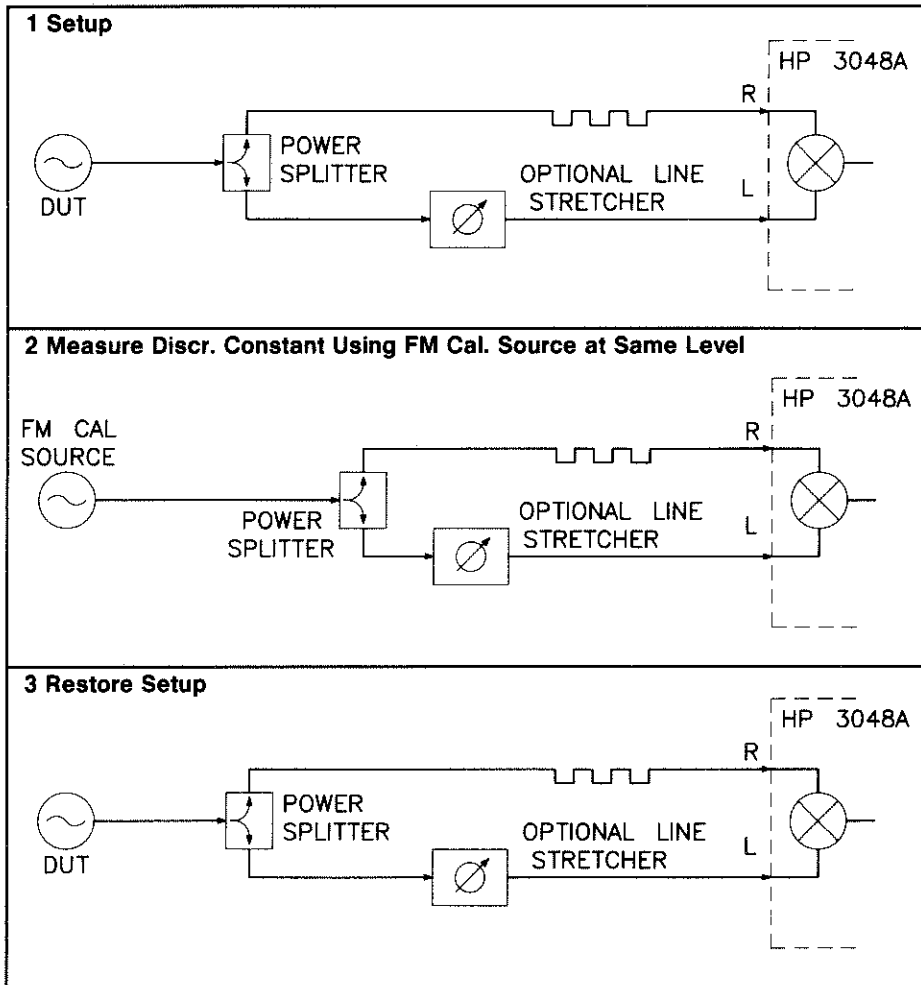

**Figure 2-24. Setup Block Diagram for the FM Rate and Deviation Spur Calibration Method**

## Description of the FM Rate and Deviation Spur Calibration Method

The Calibration Source must have a calibrated FM output. The FM accuracy of the calibration source must be within 10% to ensure the required Discriminator Constant accuracy of less than 1 dB. (If the DUT has a calibrated FM output it can be used as the calibration source.) In most cases, the DUT will be replaced by a calibration source for determining the Discriminator Constant. The calibration source output level must be adjusted to within  $\pm 0.3$  dB of the DUT's output level.

The FM Deviation must be less than  $\frac{1}{100\tau}$  to maintain the small angle criteria. A recommended frequency rate of less than  $\frac{1}{10\tau}$  will ensure that the calibration spur is within the linear region of the discriminator. (A rate of greater than  $\frac{1}{2\pi\tau}$  is beyond the linear response region. A frequency of greater than  $\frac{1}{2\pi\tau}$  violates the Small Angle Criteria and will produce invalid results.)

The FM Rate and Deviation method can be performed either manually or with system control.

**Manual control** If the calibration source is not under system control, you will be required to connect the calibration source, adjust it to the appropriate settings (the parameters defined for the measurement), and adjust its frequency to obtain quadrature when the Connect Diagram appears. The Connect Diagram will appear again after the calibration process is complete to provide connection information for the DUT. The output level of the DUT must be within  $\pm 0.3$  dB of the calibration source level to ensure the validity of the Discriminator Constant.

**System Control** The system can control the calibration source if it is a supported RF Source and has been configured in the System Configuration Table. The RF Source to be used as the calibration source must also be configured in the Source Control Diagram.

Calibration Process under system control requires the entry of the FM Rate and Deviation in the Calibr. Process menu. The Connect Diagram will provide the connection information for the calibration source. Once the calibration source is connected to the system, the HP 3048A will set the calibration source to the entered parameters, adjust the frequency to obtain quadrature, and measure the Discriminator Constant. After the calibration process is completed the Connect Diagram will appear again showing the connections for the DUT. The output level of the DUT must be within  $\pm 0.3$  dB of the calibration source level to ensure the validity of the Discriminator Constant.

## **Considerations for the Derive From FM Rate and Deviation Method**

The HP 11848A's front-panel meter can be used as an aid for adjusting quadrature. The meter has a full scale sensitivity of 20 mV with a 2 mV/Div resolution. The meter reading must be within  $\pm 1$  division of center scale for starting a measurement and must remain within  $\pm 2$  divisions of the center during the measurement.

# AM Noise

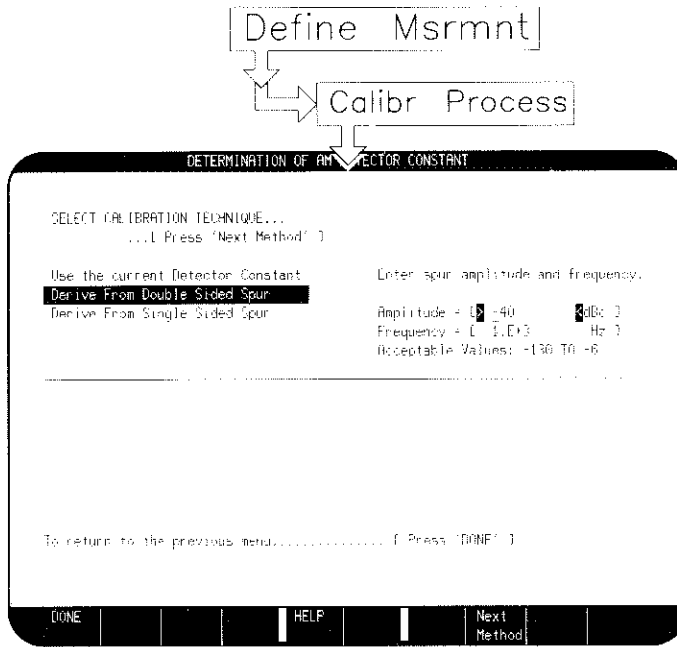

## Introduction

Calibration of the AM Noise measurement type involves calibration of the AM Detector Constant. The Detector Constant is the sensitivity of the AM detector being used for the measurement expressed in equivalent V/Rad. The noise floor (or maximum sensitivity of the system) is set by the Detector Constant.

The amplitude of the AM detector's voltage output is proportional to the AM noise (modulation) fluctuations at its input and its sensitivity. The AM detector's sensitivity is a function of the power level at its input.

Calibration for an AM Noise measurement involves measuring the relationship between a known signal and the output of the AM detector being used. There are three methods available for calibrating the AM

Detector Constant. The primary considerations for selecting a calibration method are measurement accuracy and equipment availability.

Technique	Equipment Required	Accuracy
Use the current Detector Constant	None	*
Derive From Double Sided Spur	Source with calibrated AM or calibrated amplitude modulator.	Very Good
Derive From Single Sided Spur	Directional coupler, RF analyzer, RF source.	Very Good
* Accuracy depends on which technique was used to determine the Detector Constant in memory.		

## Use the Current Detector Constant

### Introduction

This calibration method configures the HP 3048A to use the Detector Constant currently in memory. This eliminates the time spent calibrating the AM Detector Constant. The AM Detector Constant in memory is the value that was determined by the last AM Noise measurement made (unless a stored Test File has been loaded). The Detector Constant value appears in the Calibration Process display.

The Detector Constant is valid for repeat measurements of similar devices as long as the same detector is being used and the input power levels here remained the same (within  $\pm 0.3$  dB).

## Parameter Entry Descriptions

### Entering a Detector Constant

The Detector Constant's value may be changed by keying in the desired value. The Acceptable Limits for the Detector Constant are shown on the display. (Keep in mind that absolute measurement accuracy depends on the accuracy of the Detector Constant.)

### Estimating the Detector Constant

An estimate of the Detector Constant can be made directly from the detector's power level if the detector's sensitivity is known. A power meter or a spectrum analyzer can be used to measure the power level. The following graph can be used to determine the Detector Constant for an HP 33330C Low Barrier Schottkey Diode Detector.

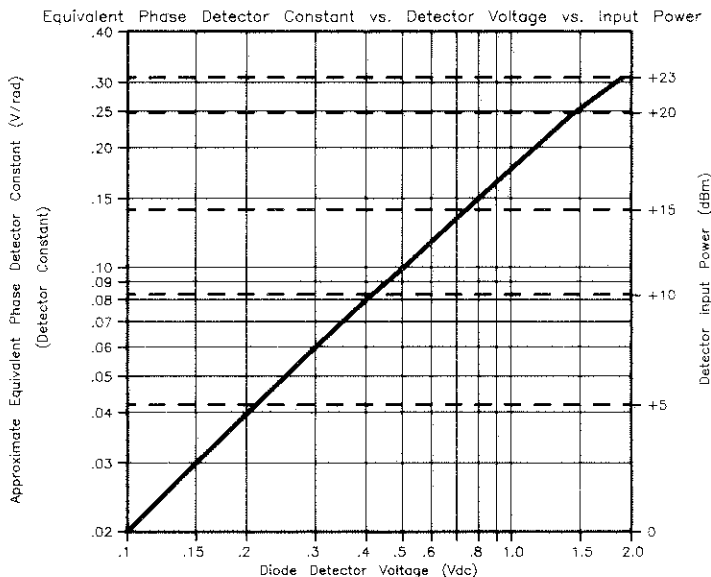

**Figure 2-25. Relationship between Detector Constant and Input Power Level for the HP 33330C**

## **Considerations When Using the Current Detector Constant**

User entry is potentially the least accurate method for determine the Detector Constant.

This calibration method does not verify the accuracy of the Detector Constant. It relies strictly on the user to ensure the validity of the Detector Constant being used. (Keep in mind that the accuracy of the Detector Constant relates directly to the accuracy of the measurement. A Detector Constant accurate to within  $\pm 1$  dB will guarantee a measurement accuracy of  $\pm 2$  dB.)

An accuracy degradation may be acceptable when only the relative shape of a device's noise characteristics is important rather than the absolute noise level. In this case, only a crude approximation of the Detector Constant is necessary.



# Derive From Double Sided Spur

## Introduction

The Derive From Double Sided Spur method is one of the most accurate Detector Constant Calibration methods available. However, it requires additional equipment and presents a high level of technical difficulty.

This calibration method requires the generation of modulation sidebands (AM). The sideband (spur) level relative to the carrier level (dBc) and the spur offset frequency must first be determined using an RF spectrum analyzer or modulation analyzer. You will be required to define the relative level and offset frequency values in the Calibration Process display either during the measurement definition or when you reach the Connect Diagram.

The system measures the spur level at the output of the detector and calculates the Detector Constant.

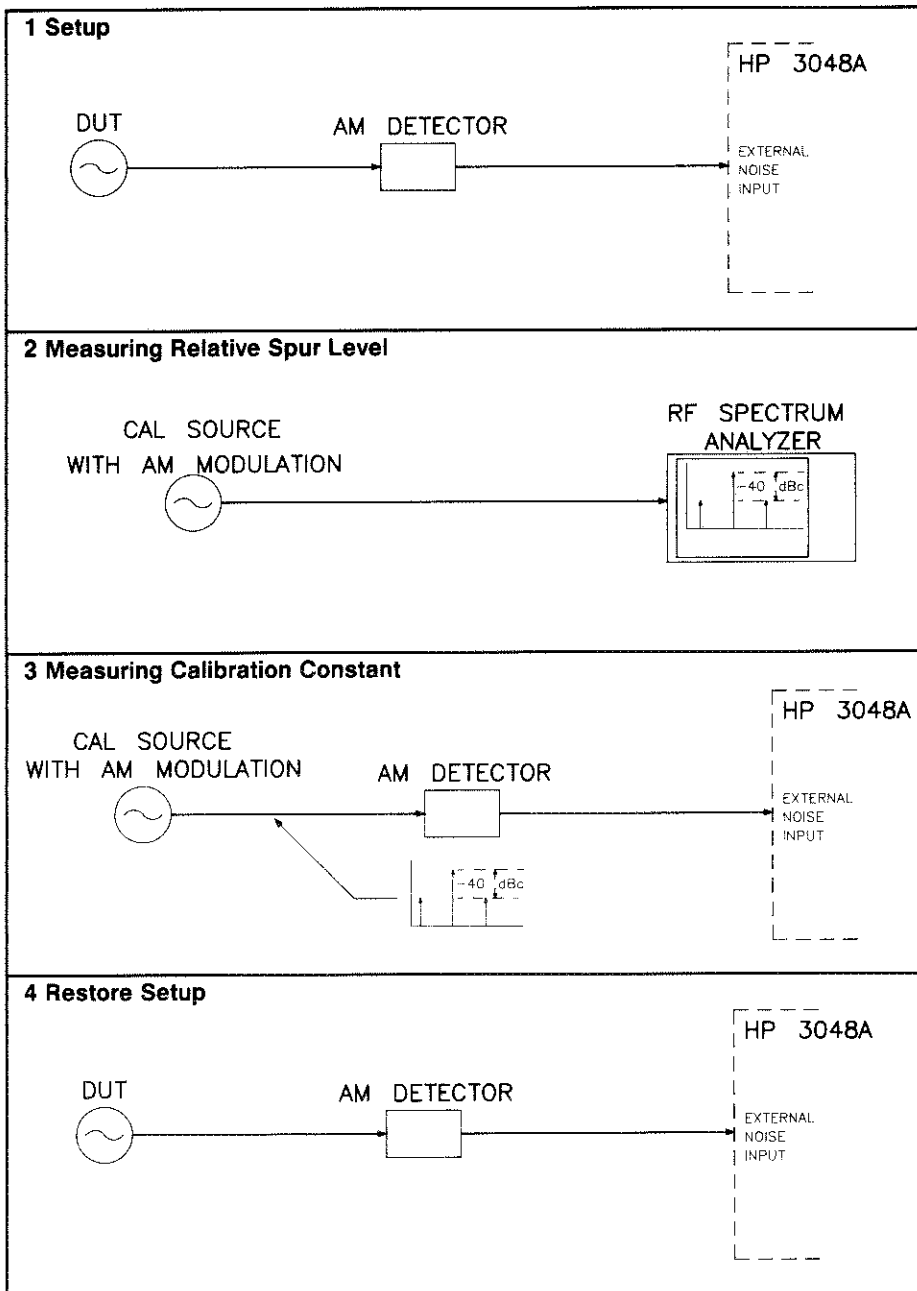

Figure 2-26. Setup Block Diagram for the Double-Sided Spur Calibration Method

## Description of the Double Sided Spur AM Detector Calibration Method

An RF spectrum analyzer or modulation analyzer is required to measure the fundamental signal and the spur. A spur level of  $-30$  to  $-60$  dBc is recommended. (If you are using a supported source that is under system control to generate the calibration spur, you will be required to enter the relative amplitude of the spur. An entry of  $-40$  dBc is recommended; 2% AM produces a  $-40$  dBc sideband.) The calibration spur can be set at a frequency offset of 1 Hz to 100 kHz (20 MHz with a supported RF analyzer).

---

### NOTE

The HP 3048A expects the DUT to be set to the same power level as the calibration source prior to beginning the measurement.

---

It is important to insure that the level of the calibration spurs is greater than the level of any other spurious signals present in the frequency spectrum. Also, you should evaluate both sideband calibration spurs to ensure that they are equal in amplitude. (Any deviation in the amplitude of the calibration spurs indicates the presence of phase modulation in the measurement circuit. The HP 3048A's specified measurement accuracy is maintained as long as the difference in the sideband levels is less than 2 dB, and the average value of the levels is used.)

When the Connect Diagram appears, the Calibr Process softkey will provide access to the the Determination of Phase Detector Constant display where the calibration spur values can be entered.

When the system measures the calibration spur, the analyzer does a peak search over a frequency span of two times the entered spur offset frequency. Once the spur has been located, the level of the spur is measured and used to calculate the Detector Constant.

## **Considerations for the Derive From Double Sided Spur Method**

Requires an RF Spectrum Analyzer or modulation analyzer capable of measuring the carrier frequency and the modulation sidebands unless a calibrated AM source is being used.

For optimum results, an input power level of +10 dBm is recommended for the HP 33330C LBSD AM Detector.

Unequal sidebands on the carrier potentially indicate a  $\Phi$ M component is present. If the sidebands are greater than 2 dB a different calibration source should be used. Variations greater than 2 dB can effect the certainty of the Detector Constant.

When under system control, the calibration source is set for an output level of +10 dBm. If this level setting is not possible on the source you are using, return to the Source Control menu and select manual control for the calibration source. This will allow you to control the source level output.

The amplitude value entered in the Calibration Process display is used to derive the percentage of modulation at which to set the calibration source. If the calibration source does not provide the necessary resolution for setting the exact percentage derived from the entered amplitude, the Detector Constant will be in error. It is therefore recommended that -40 dBc be entered as the amplitude; this value corresponds to a two percent modulation which is available in all of the supported RF Sources.

# Derive From Single Sided Spur

## Introduction

The Derive From Single Sided Spur method is a very accurate method for calibrating the Detector Constant. However, it requires additional equipment and presents a high level of technical difficulty.

This calibration method requires that an additional signal (representing the spur) is applied to the input of the AM Detector being used. The AM sideband (spur) level relative to the carrier level (dBc) and the spur offset frequency must be determined using an RF spectrum analyzer. You will be required to define the relative level and offset frequency values in the Calibration Process display either during the measurement definition or when you reach the Connect Diagram.

The system measures the spur level at the output of the detector and calculates the Detector Constant.

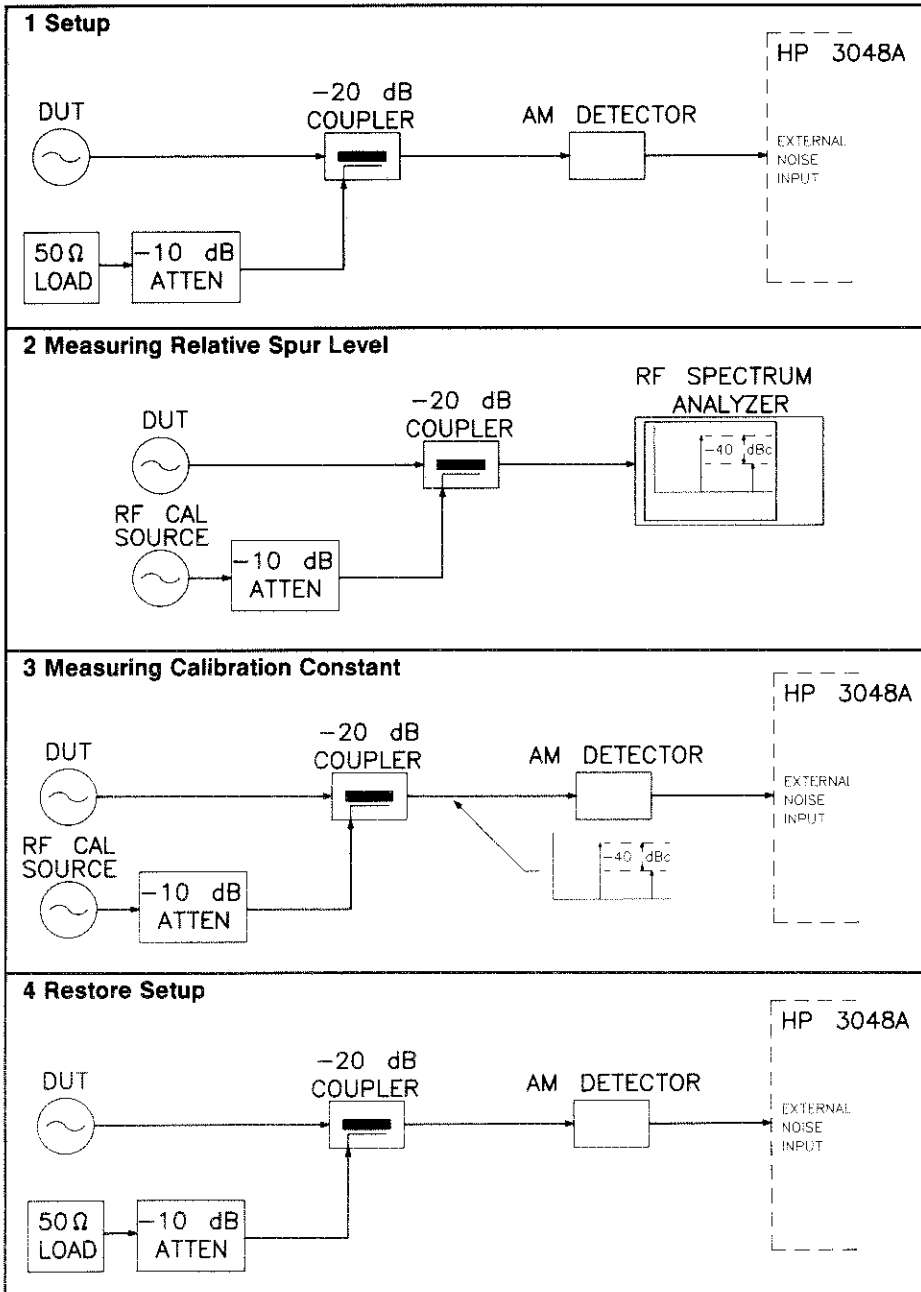

Figure 2-27. Setup Block Diagram for the Single-Sided Spur Calibration Method

## Description of the Single Sided Spur AM Detector Calibration Method

A second RF signal generator and a directional coupler are required to inject the calibration spur. The calibration spur should be adjusted to approximately  $-40$  dBc at an offset frequency that can be accurately measured with the RF analyzer.

---

### NOTE

The HP 3048A expects the DUT to be set to the same power level as the calibration source prior to beginning the measurement.

It is important to insure that the level of the calibration spur is greater than any other spurious signals present in the frequency spectrum.

---

When the Connect Diagram appears, the Calibr Process softkey will provide access to the the Determination of Phase Detector Constant display where the calibration spur values can be entered.

When the system measures the calibration spur, the analyzer does a peak search over a frequency span of two times the entered spur offset frequency. Once the spur has been located, the level of the spur is measured and used to calculate the Detector Constant. (The HP 3048A will inform you when to remove the calibration spur.)

## **Considerations for the Derive From Single-Sided Spur Method**

The power level at the AM detector input must remain the same for both calibration measurements and the noise measurements. For optimum results, a power level of +10 dBm is recommended when using the HP 33330C AM Detector.

Requires an RF Spectrum Analyzer capable of measuring the calibration spur at the desired carrier frequency. Requires a second RF Generator that can be set to an offset frequency of from 1 Hz to 100 kHz (or 20 mHz if an RF Analyzer is configured in the system).

Calibration is performed under actual measurement setup conditions.

The non-linearity and harmonics of the AM detector are calibrated out.



## Noise Measurement Using HP 3561A Only

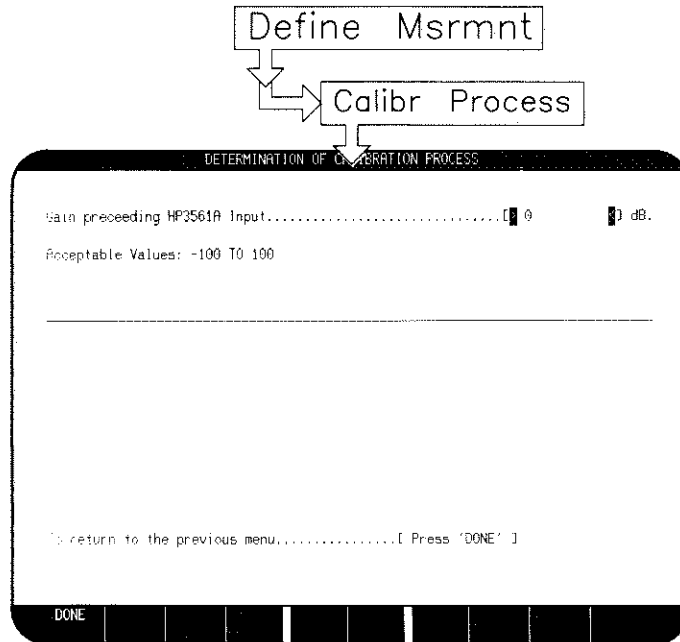

This function is used to offset the plotted measurement data. It compensates for any additional amplifiers or attenuators being used when making the measurement.

Offsets  $>0$  compensate for known losses.

Offsets  $<0$  compensate for known gains.

# Baseband Noise Measurement

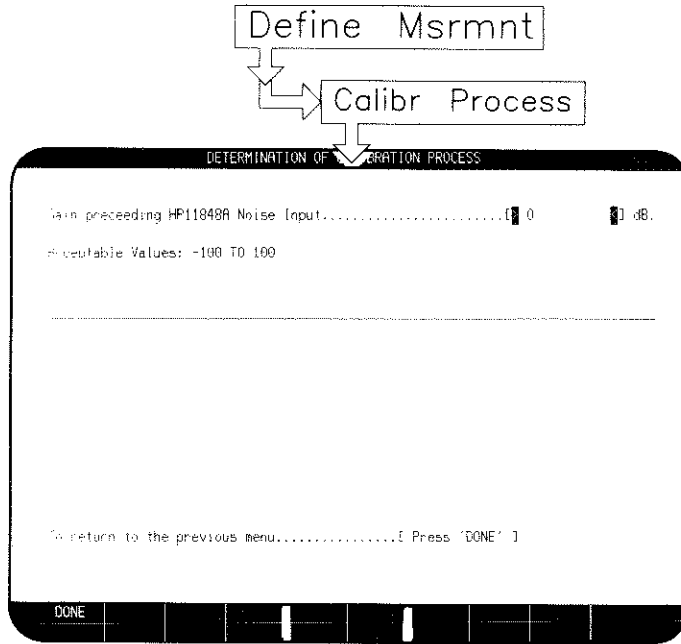

This function is used to offset the plotted measurement data. It compensates for any additional amplifiers or attenuators being used when making the measurement.

Offsets  $>0$  compensate for known losses.

Offsets  $<0$  compensate for known gains.

# Source Control

## Introduction

The Source Control Diagram specifies what devices are to be used in the measurement and which devices are to be controlled by the HP 3048A via the HP-IB. The Measurement Type selected in the Type/Range display determines which measurement configuration will appear in the Source Control display. The Source Control Diagram determines what will be displayed in the Connect Diagram at the beginning of the measurement.

Softkeys are provided for manipulating the Source Control Diagram to configure it to represent the desired measurement setup. For example, to activate the Reference Source block, press the **Ref. Source** softkey once. Pressing the **Ref. Source** softkey after the block has been activated steps through the available reference source options. (Reference Sources (other than those internal to the HP 11848A) must be configured in the System Configuration Table to appear in the Source Control Diagram.) While the Ref. Source block is active, the **Control** softkey allows selection of either Manual or System (HP-IB) control.

<b>Phase Noise Using a Phase Lock Loop</b> .....	pg. 2-102
<b>Phase Noise Without Using a PLL</b> .....	pg. 2-105
<b>Phase Noise Using an FM Discriminator</b> .....	pg. 2-108
<b>AM Noise</b> .....	pg. 2-111
<b>Noise Measurement Using HP 3561A Only</b> .....	No Entry Required
<b>Baseband Noise Measurement</b> .....	No Entry Required

## Phase Noise Using a Phase Lock Loop

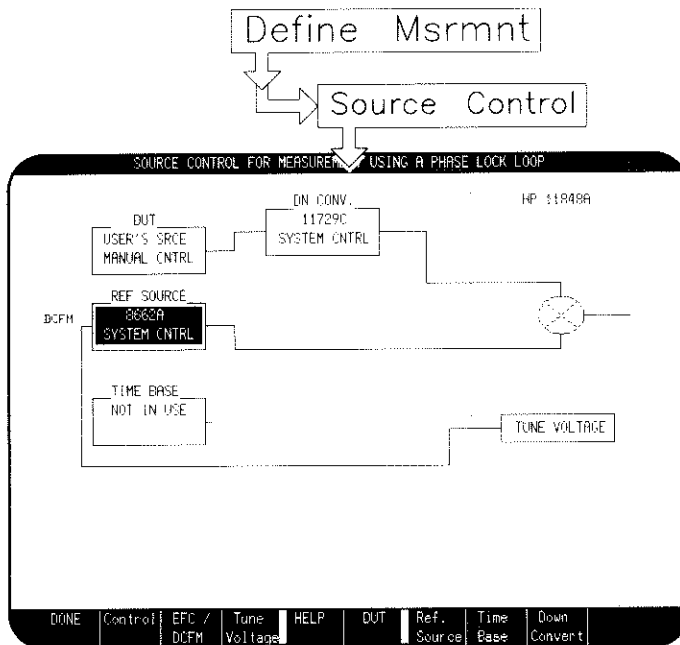

### Softkey and Block Description

When configuring the Source Control Diagram, it is important that the correct connections are made and that the appropriate device is shown in each block being used. For the Phase Noise Using a Phase Lock Loop measurement type, the following blocks will appear in the display.

**REF. SOURCE:** Any of the HP 11848A Internal Sources or any RF Sources defined in the System Configuration Table can be placed under System Control. Reference Sources other than HP 11848A Internal Sources must be defined in the System Configuration Table as RF Source, RF Source1, or RF Source2. If the Reference Source is the VCO for the measurement, it can be tuned by either the Tune Voltage or via the Time Base.

**TUNE VOLTAGE:** The Tune Voltage can be configured to tune the VCO Source directly (Reference or DUT), or to tune the Time Base when the Time Base has been configured to tune the Reference Source. One of the two sources being measured must be a VCO, either directly or through at Time Base.

**TIME BASE:** The Time Base connects directly to the Reference Source. The Time Base can be either an HP 11848A Internal 10 MHz A or the 10 MHz B Source, or a Users VCO Source under Manual Control.

**DUT (DEVICE UNDER TEST):** The System will allow you to specify a USER's Source, or any of the HP 11848A Internal Sources as a System Controlled DUT. A DUT can be placed under System Control if its setup can be controlled with an HP-IB BASIC Character string statement. (An RF Source defined in the System Configuration Table cannot be selected as the DUT source).

**DUT SETUP STRING:** The DUT setup string field provides for entry of the required command string for setting up the DUT source for the measurement when the DUT is to be under System Control. (The HP 11848A's Internal Sources do not require entry of a setup string.)

For example, for an HP 8642B Signal Generator, the following command string would be required to Preset the instrument and set it to 100 MHz at 16 dBm. (Refer to the operating manual provided for the source being used for appropriate HP-IB commands.)

OUTPUT 719: "PP FR 100MZ AP16DM"

**DN CONV:** The Down Converter is used to down convert the DUT frequency to a frequency within the frequency range of the Reference Source. The Down Converter can be either a Users device under Manual Control or an HP 11729C under either System or Manual Control. (The HP 11729C must be listed in the System Configuration Table to be under System Control.)

## **Considerations for the Phase Noise Using a Phase Lock Loop Measurement**

When loading a Test File from the Mass Storage Media, it is possible for the Source Control Diagram to be configured incorrectly. If the Source Control Diagram contained in a Test File that is being loaded specifies an instrument that is not listed in the current System Configuration Table, the HP 3048A will not be able to include the specified instrument in the Source Control Diagram. Instead, the HP 3048A will specify the instrument that is currently listed in the System Configuration Table, or if an appropriate instrument is not listed, the Users Source specification will be selected. (The System Configuration Table is not stored with the Test File.)

Changing the Measurement Type can change the Source Control Diagram as well as other Measurement Definitions. It is recommended that you verify all Measurement Definition screens after selecting a new Measurement Type.

## Phase Noise Without Using a PLL

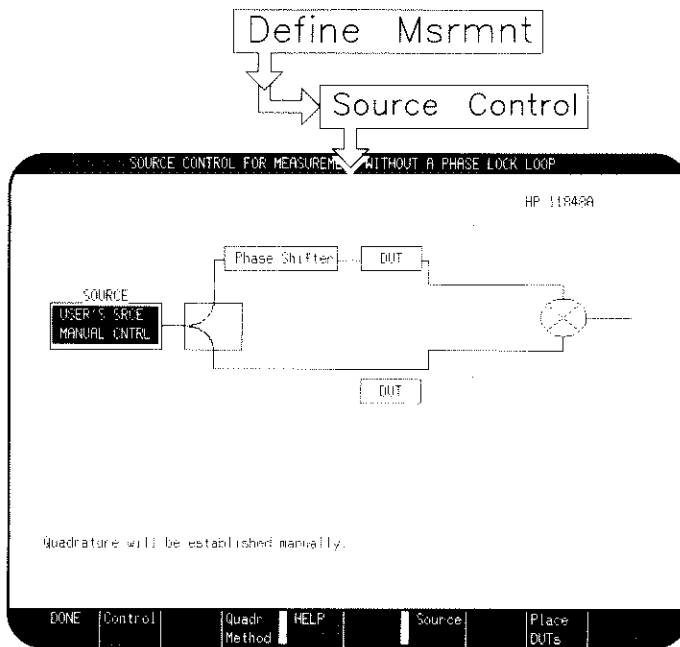

### Softkey and Block Description

When configuring the Source Control Diagram, it is important that the correct connections are made and that the appropriate device is shown in each block being used. For the Phase Noise Without Using a PLL measurement type, the following blocks will appear in the display.

**Source:** This block defines the signal source to be used for the measurement. Either an HP 11848A Internal Source, a USER's Source, or any RF Source defined in the System Configuration Table can be specified.

---

## NOTE

When measuring a Two Port device, the AM Noise contribution of the Source can affect the measurement. It is recommended that a Source with Low AM Noise be used to ensure good results.

---

**Phase Shifter:** When the source frequency cannot be adjusted, a Phase Shifter is required for achieving quadrature for the Residual Two Port measurement.

**DUT:** The DUT blocks allow for either one or two devices to be configured in the measurement paths. The DUT blocks are positioned by pressing the **Place DUTs** softkey. You must configure a device in both measurement paths when measuring devices that translate frequency or add large amounts of phase delay. The physical connection of where the DUT is placed with respect to the Phase Shifter is not important (unless the Two Port device to be measured translates the frequency). In this case, the frequency range of the Phase Shifter needs to be considered.

DUT placement is done only to help visualize the measurement configuration and specify a correct Connect Diagram including DUT's. DUT placement has no affect on any facet of system operation.

**Quadrature:** The System allows you to specify how quadrature (90° phase shift) will be set. Pressing the **Quadr Method** toggles the quadrature selection between adjustment of the source frequency and the manual method. (If the source is under System Control and entered in the System Control Table, the frequency adjustment will be automatic.) The manual method requires a phase shifter (or adjustable line stretcher) to achieve quadrature.



## **Considerations for the Phase Noise Without Using a PLL Measurement**

When loading a Test File from the Mass Storage Media, it is possible for the Source Control Diagram to be configured incorrectly. If the Source Control Diagram contained in a Test File that is being loaded specifies an instrument that is not listed in the current System Configuration Table, the HP 3048A will not be able to include the specified instrument in the Source Control Diagram. Instead, the HP 3048A will specify the instrument that is currently listed in the System Configuration Diagram, or if an appropriate instrument is not listed, the Users Source specification will be selected. (The System Configuration Table is not stored with the Test File.)

Changing the Measurement Type can change the Source Control Diagram as well as other Measurement Definitions. It is recommended that you verify all Measurement Definition screens after selecting a new Measurement Type.

## Phase Noise Using an FM Discriminator

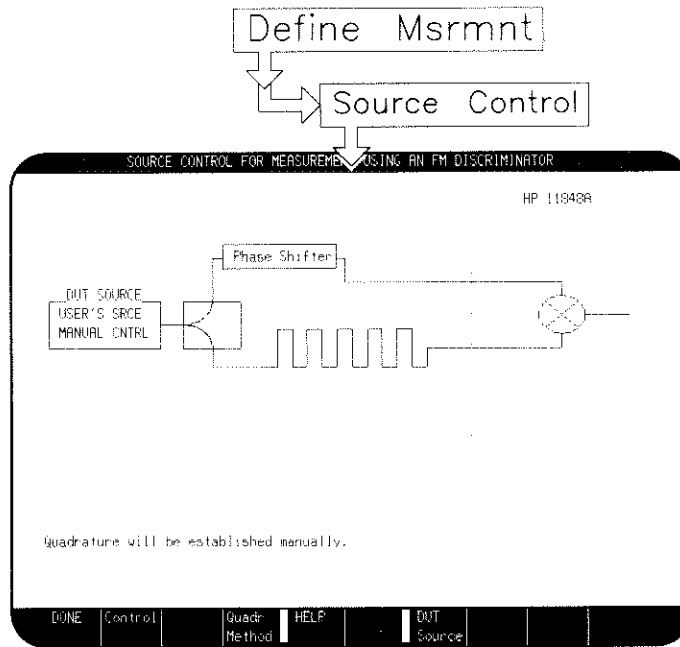

### Softkey and Block Description

When configuring the Source Control Diagram, it is important that the correct connections are made and that the appropriate device is shown in each block being used. For the Phase Noise Using an FM Discriminator measurement type, the following blocks will appear in the display.

**DUT SOURCE:** This block defines the signal source to be measured. In most cases the DUT SOURCE will be a USER'S Source under manual control. One of the HP 11848A Internal sources, or an defined RF Source defined in the System Configuration Table can also be defined.

**Phase Shifter:** A Phase Shifter is required to achieve quadrature for the FM Discriminator measurement when the source frequency cannot be adjusted. Depending on the Quadrature Method selected, the HP 3048A responds differently. For example, if you specify "Quadrature will be established by adjusting the source frequency", you will have to adjust the frequency of the source to obtain quadrature, (unless the source is under System control). If "Quadrature will be established manually" is specified, the HP 3048A expects you to acquire quadrature by adjusting the phase shift of one path.

**Cal Source:** This block will appear on the Source Control display when "Derive from Rate and Deviation" Calibration Process was selected. Either a users Cal Source under Manual Control or a supported RF Source under System Control can be selected for the Calibration Source. The Calibration Source must have a calibrated FM output. Under Manual Control the system will prompt you to connect the Cal Source and apply modulation as well as disconnect it after the calculation process is complete.

**Delay Line:** The Delay Line is represented by  in the diagram. A Delay Line is required to decorrelate the Phase Noise of the DUT. (FM Discriminator)

(Refer to Graph 5 Approximate Sensitivity of Delay Line Discriminator Chapter 7 Quick Reference for details on required delay lines.)

## **Considerations for the Phase Noise Using an FM Discriminator Measurement**

When loading a Test File from the Mass Storage Media, it is possible for the Source Control Diagram to be configured incorrectly. If the Source Control Diagram contained in a Test File that is being loaded specifies an instrument that is not listed in the current System Configuration Table, the HP 3048A will not be able to include the specified instrument in the Source Control Diagram. Instead, the HP 3048A will specify the instrument that is currently listed in the System Configuration Diagram, or if an appropriate instrument is not listed, the Users Source specification will be selected. (The System Configuration Table is not stored with the Test File.)

Changing the Measurement Type can change the Source Control Diagram as well as other Measurement Definitions. It is recommended that you verify all Measurement Definitions after selecting a new Measurement Type.

# AM Noise

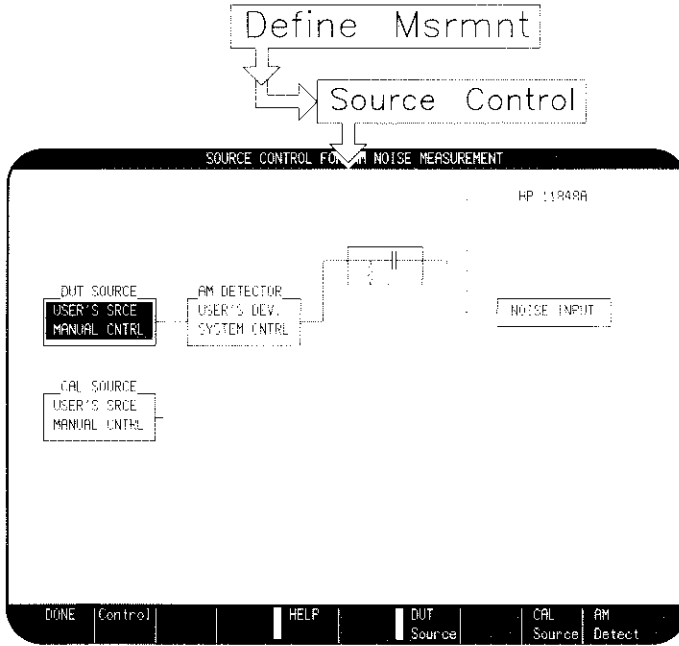

## Softkey and Block Description

When configuring the Source Control Diagram, it is important that the correct connections are made and that the appropriate device is shown in each block being used. For the AM Noise measurement type, the following blocks will appear in the display.

**DUT SOURCE:** This block defines the signal source to be measured. In most cases, the DUT SOURCE will be a USER's Source under manual control. The HP 3048A will also allow you to specify one of the HP 11848A Internal sources, or an RF Source defined in the System Configuration Table.

**AM Detector:** This block specifies the Amplitude Modulation Detector. In most cases, the AM Detector will be a USER's device under manual control (although the System will allow you to specify the HP 11729C Option 130 as an AM Detector). The HP 11729C Option 130 includes an Internal AM Detector. The HP 11729C can be controlled manually, or it can be under System control when it has been entered in the System Configuration Table. (The HP 11729C should be entered as a Down Converter in the System Configuration Table.)

**Cal Source:** This block will appear on the Source Control display when "Derive from Double Sided Spur" Calibration Process was selected. Either a users Cal Source under Manual Control or a supported RF Source under System Control can be selected for the Calibration Source. The Calibration Source must have a calibrated AM output. Under Manual Control the system will prompt you to connect the Cal Source and apply modulation as well as disconnect it after the calculation process is complete.

**DC Block:**

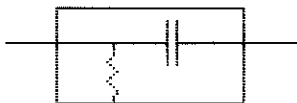

The HP 11848A Phase Noise Interface must be dc blocked when using its NOISE INPUT. The Interface will not tolerate more than  $\pm 2$  mv DC Input without overloading the LNA. A DC block must be connected in series after the AM Detector to remove the dc component. A blocking circuit is not provided with the HP 3048A. A dc block can either be constructed or purchased. The HP 3048A Option K21 is designed specifically for this purpose.

## **Considerations for the AM Noise Measurement**

When loading a Test File from the Mass Storage Media, it is possible for the Source Control Diagram to be configured incorrectly. If the Source Control Diagram contained in a Test File that is being loaded specifies an instrument that is not listed in the current System Configuration Table, the HP 3048A will not be able to include the specified instrument in the Source Control Diagram. Instead, the HP 3048A will specify the instrument that is currently listed in the System Configuration Diagram, or if an appropriate instrument is not listed, the Users Source specification will be selected. (The System Configuration Table is not stored with the Test File.)

Changing the Measurement Type can change the Source Control Diagram as well as other Measurement Definitions. It is recommended that you verify all Measurement Definitions after selecting a new Measurement Type.

## Define Graph

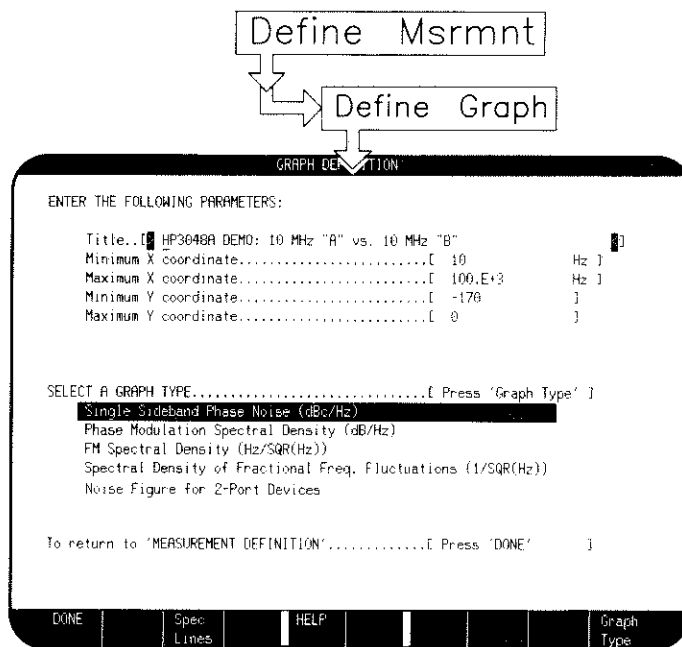

## Introduction

The Define Graph display allows you to specify the Measurement Results graph characteristics. The graph title, X axis range, Y axis range, and graph type for the graph are defined in this display.

## Softkey Descriptions

**Spec Lines:** This softkey appears on the Define Graph display. It accesses the display for setting specification limit lines on the Results Graph.

**DSC FLR OFF and SML ANG OFF:** These softkeys enable the small angle criterion and/or discriminator noise floor lines to be drawn on the graticule.



## Parameter Entry Descriptions

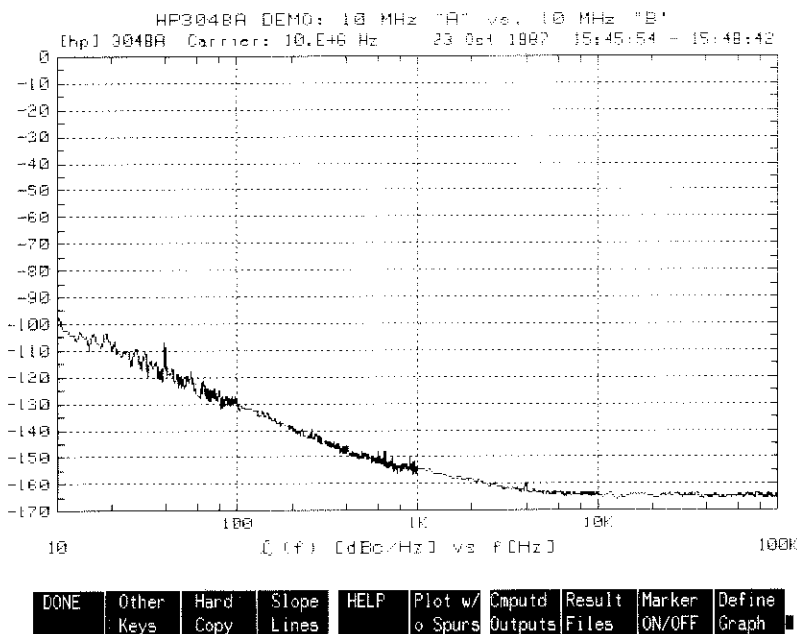

**Figure 2-28. Measurement Results Graph**

**Title:** This parameter allows you to enter a title for the Results Graph (up to 58 characters long).

**Minimum X Coordinate:** This parameter specifies the start value (frequency) for the X axis on the graph. The entry can be in integer or exponential form. The acceptable limits are 1.E-3 Hz. to 10.E+9 Hz. This value must be less than the Maximum X coordinate.

**Maximum X Coordinate:** This parameter specifies the stop frequency for the X axis on the graph. The entry can be in integer or exponential form. The acceptable limits are 1.E-3 Hz. to 10.E+9 Hz. This value must be greater than the Minimum X coordinate.

**Minimum Y Coordinate:** This parameter specifies the upper limit of the Y axis. The entry can be in integer or exponential form. The acceptable limits are displayed on the screen. Units for the Y axis are determined by the Graph Type selected. This value must be less than the Maximum Y coordinate.

**Maximum Y Coordinate:** This parameter specifies the lower limit of the Y axis. The entry can be in integer or exponential form. The acceptable limits are displayed on the screen. Units for the Y axis are determined by the Graph Type selected. This entry must be greater than the Minimum Y coordinate.

**Graph Type Other than AM or Baseband Noise:** This parameter specifies the data type in which the measurement results will be displayed.

- **Single-sideband phase noise (dBc/Hz).** The HP 3048A computes  $\mathcal{L}(f)$  as:  $\int_{f_1}^{f_2} \frac{S_{\phi}(f)}{2} df$ , and plots the results in dBc.
- **Phase Modulation Spectral Density (dB/Hz).** The HP 3048A computes  $S_{\phi}(f)$  as:  $\int_{f_1}^{f_2} S_{\phi}(f) df$ , and plots the results in dB with respect to 1 radian (Radians, and Degrees).
- **FM Spectral Density (Hz/ $\sqrt{\text{Hz}}$ ).** The HP 3048A computes  $S_{\nu}(f)$  as:  $\int_{f_1}^{f_2} S_{\phi}(f) \times f^2 df$ , and plots the results in Hz (Residual FM).
- **Spectral Density of Fractional Frequency Fluctuations (1/ $\sqrt{\text{Hz}}$ ).** The HP 3048A computes  $S_y(f)$  as:  $\int_{f_1}^{f_2} S_{\phi}(f) \times \left(\frac{f}{f_{\text{carrier}}}\right)^2 df$ , and plots the results without units.
- **Noise Figure for 2-Port Devices.** The HP 3048A computes the noise figure (NF) as:  $S_{\Phi}(f) + 174 + Pin$ , and plots the results as dB/Hz. Pin is the input power listed in the Computed Output "Input Power at Amplifier..." field.

**Horizontal Portion of the Display to be Used:** This parameter allows you to specify the percentage of the horizontal display area you want to use for displaying plots.

If you are using a large high-resolution monitor and you want to print out a plot, part of the display's output may be ignored by a printer with less horizontal printing capability than shown on your display. Specifying a smaller amount of the display to be used for the plot allows the printer to print all of the plot shown on your display.

For instance, if you are using an HP 98785A monitor with a Model 350 computer and a PaintJet Printer, using a horizontal scale of 70% and a vertical scale of 53% allows the entire result plot to be printed.

The new graph size is not displayed until Redraw Graph or Redraw Graticule is pressed.

**Vertical Portion of Display to be Used:** This parameter allows you to specify the percentage of the vertical display area you want to use for displaying plots.

If you are using a large high-resolution monitor and you want to print out a plot, part of the display's output may be ignored by a printer limited to fewer vertical lines of resolution than the computer display. Specifying a smaller amount of the display to be used for the plot allows the printer to print all of the plot shown on your display.

For instance, if you are using an HP 98785A monitor with a Model 350 computer and PaintJet Printer, using a horizontal scale of 70% and vertical scale of 53% allows the entire result plot to be printed.

The new graph size is not displayed until Redraw Graph or Redraw Graticule are pressed.

## Placing Specification Lines on the Graph

The Spec Lines feature allows you to place a reference line (specification line) on the Results Graph.

The Spec Lines softkey accesses a display that allows you to define a specification line by entering the offset frequency and amplitude for up to 22 points along the line. The points are connected on the Results Graph with linear lines in the order in which they are entered. The Next Page softkey accesses points 12–22.

For example, if you wished to draw a line on the Results Graph that starts at  $-60$  dBc at  $100$  Hz, with a  $-20$  dB per decade slope to  $1$  kHz, then change to a  $-10$  dB per decade slope to  $100$  kHz, you would enter the parameters shown in the following Specification Line Table.

DEFINITION OF NOISE SPEC LINES			
	Offset Frequency (Hz)	Amplitude (dBc/Hz)	
Point # 1:	[ 10 ]	[ -30 ]	
Point # 2:	[ 1.E+3 ]	[ -70 ]	
Point # 3:	[ 10.E+3 ]	[ -80 ]	
Point # 4:	[ 100.E+3 ]	[ -80 ]	
Point # 5:	[ ]	[ ]	
Point # 6:	[ ]	[ ]	
Point # 7:	[ ]	[ ]	
Point # 8:	[ ]	[ ]	
Point # 9:	[ ]	[ ]	
Point #10:	[ ]	[ ]	
Point #11:	[ ]	[ ]	

Acceptable Values: 10.E-3 TO 10.E+9

To return to 'GRAPH DEFINITION'.....[ Press 'DONE' ]

DONE	Delete Point	Next Page	HELP				
------	--------------	-----------	------	--	--	--	--

Figure 2–29. Example of Noise Spec Line Table

## **Consideration for Defining the Results Graph**

The HP 3048A will complete a measurement even though the ranges defined for the measurement are incorrect. Graph characteristics can be changed when the Measurement Results are displayed after the measurement is complete.

# Test Files

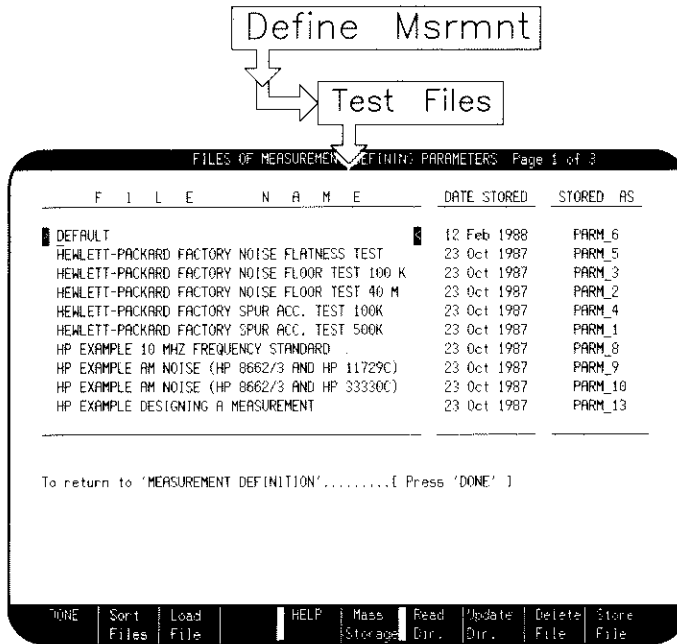

## Introduction

Test Files are stored in the specified Mass Storage Media. When you store a Test File, the HP 3048A stores the currently defined measurement parameters, and the calibration constants created by the HP 3048A when the measurement was run. (The System Configuration Table entries are not stored in the Test File.)

Storing and Loading a Test File can save time and insure that the parameter entries are identical each time a particular measurement is made. Also, it may be helpful to load and modify an existing Test File for making a new measurement for a similar type of device.

## Description of the Test Files

### Test Files Shipped with the HP 3048A

When the HP 3048A is shipped, it includes several predefined Test Files. The Test Files included in the Data Disc are described below.

The **Default** file sets up the HP 3048A to measure the HP 11848A's Internal 10 MHz Sources (10 MHz A vs. 10 MHz B). This measurement provides a quick verification of the HP 3048A's ability to complete a Phase Noise measurement. The results for this measurement may be compared with the Default Result File also stored on the Data Disc.

---

#### NOTE

Any Test File labeled "Default" at the location "Test Parameter Files" specified in the Mass Storage Media table will be loaded automatically every time the HP 3048A Software is loaded or the System Preset softkey is pressed.

---

Files Labeled **HEWLETT-PACKARD FACTORY....** contain predefined Test Files used for performing the HP 3048A Performance Tests. (Please refer to the *HP 3048A Calibration Manual* for details on when and how to perform these tests.)

Files Labeled **HP EXAMPLE....** contain predefined test parameters. The predefined parameters are typical values for measuring the devices indicated by the Test File labels. These files are provided to aid you in setting up your own measurements. (Details for applying or modifying these files to meet your needs are provided in the *HP 3048A Operating Manual*.)

Files Labeled **HP TEST....** contain predefined Performance Tests required to verify operation of the HP 3048A System and its supported options. For example, *HP TEST HP 11729C/8662/63 vs HP 11729C/8662/63* is the Noise

Floor Performance Test for a System configured with an HP 11729C Carrier Noise Set (Down Converter) and an HP 8662A or HP 8663A Synthesized Signal Generator. (Please refer to the *HP 3048A Calibration Manual* for details on when and how to perform these tests.)

## Softkey Descriptions

**Sort Files:** lists the files in alphanumeric order instead of chronological order.

**Load File:** recalls and loads the Test File specified by the cursor's position in the list.

**Next Page:** accesses the following pages of stored Test Files. This softkey only appears if there are more than 10 file entries listed.

**Mass Storage:** accesses the Mass Storage Media display. The locations of the System files are defined in the Mass Storage Media display. Defining the Mass Storage Media allows you to store or load Test Files from various mass media locations.

**Read Dir:** accesses the Test File Directory at the location specified in the Mass Storage Media display. This function allows you to read the directory of any disc or media that contains Test Files by inserting a new disc or changing the Mass Storage Media location for "Test Parameter Files".

**Update Dir:** allows you to re-label a Test File. Position the cursor at the Test File you wish to re-label, and type in the new label over the old label. Press the Update Dir. softkey to assign the new label to the specified Test File, and to re-list the files in alphabetical order.

**Delete File:** removes the Test File indicated by the cursor position, and re-lists the directory without the deleted file.



**Store File:** stores a Test File onto the specified Mass Storage Media. The Test File contains the defined measurement parameters and the Calibration Constants derived during the last measurement.

## **Considerations for Test Files**

The System Configuration Table is not stored with the Test File. When loading a Test File from the Mass Storage Media, it is possible for the Source Control Diagram to be configured incorrectly. If the Source Control Diagram contained in a Test File that is being loaded specifies an instrument that is not listed in the current System Configuration Table, the HP 3048A will not be able to include the specified instrument in the Source Control Diagram. Instead, the HP 3048A will specify the instrument that is currently listed in the System Configuration Table, or if an appropriate instrument is not listed, the Users Source specification will be selected.

Copying the Test Files using the copy routine provided in the Basic Operating System will not update the Test File Directory and may cause loss of the data. Copy Test Files from one disc to another by loading the Test File into the System, then storing the Test File on to the other disc.

The Parm\_number shown for each Test File represents the media file name and the order in which the Test Files were stored.

# How to Manage the Test Files

## Storing a Test File

It is recommended that you complete the measurement before storing the Test File to ensure that all of the entered parameters in the Measurement Definition are correct. Also, when the Test File is stored after the measurement has been completed, the correct calibration constants for the measurement are stored as well. You can then perform a Repeat Measurement directly after loading a Test File for measuring devices having similar characteristics. The following steps describe the storing process.

1. Press the **Test Files** softkey to access the Test File Directory display.
2. Move the cursor to the bottom of the File Name column. (If the page is full, press **Next Page** to access a page with available entry space.)

---

### NOTE

It is possible to lose data when using a hard disc or SRM Mass Storage Device for storing the Test Files. If you attempt to store more than 99 Test Files on one media, the HP 3048A will destroy previously stored Test Files.

Disc storage is usually limited to approximately 50 Test Files per disc.

- 
3. Enter a name for the file. The HP 3048A will allow 47 characters in the File Name column.
  4. Press the **Store File** softkey. The Test File will be stored in the Mass Storage Media location defined for "Test Parameter Files".

## Loading a Test File

The following steps describe the procedure for loading a previously stored Test File.

1. Press **Define Msrmnt** from the Main Software Level.
2. Press **Test Files** to access the Test File Directory.
3. Position the cursor at the file you wish to load. (Press **Next Page** to access the following pages, if necessary.)
4. Once you have positioned the cursor at the file you wish to load, press the **Load File** softkey.
5. After the file has been loaded, press **Done** to exit the Test File Directory.
6. To examine the newly loaded test definition, press **Param Summary**.

## Creating a Directory

The following steps describe the procedure for creating a new Test File Directory (Parm\_Dir).

1. Define the location of the "Test Parameter Files" in the Mass Storage Media Table.
2. Press the **Create Dir** softkey when the error message appears. (The error message indicates the HP 3048A has attempted to load the Parm\_Dir from the new media and has determined that it has not yet been created.)
3. Press the **Fixed** softkey to continue. Test Files can now be stored on the new Mass Storage Media.

# Access Graph

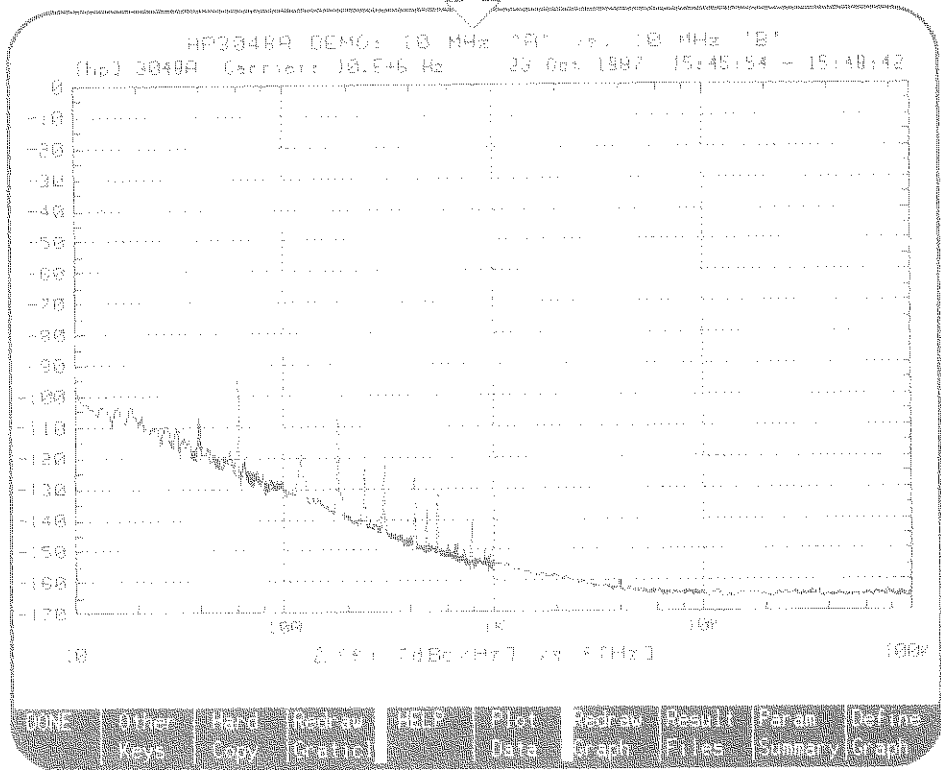

DONE	Other Keys	Hard Copy	Slope Lines	HELP	Plot w/ Source	Input/Output	Result Files	Marker ON/OFF	Define Graph
------	---------------	--------------	----------------	------	-------------------	--------------	-----------------	------------------	-----------------

# Graphics Functions

---

# 3

## Introduction

The HP 3048A Phase Noise Measurement System accesses the Graphics Functions through the Access Graph softkey. These Graphic Functions manipulate the measurement data results. For example pressing the Shift DONE softkey will redraw the graph without the horizontal graticules.

A discussion of each function and its limitations are found on the following pages.

<b>Parameter Summary</b> .....	pg. 3-3
<b>Result Files</b> .....	pg. 3-13
<b>Define Graph</b> .....	pg. 3-19
<b>Marker ON/OFF</b> .....	pg. 3-23
<b>Slope Lines</b> .....	pg. 3-25
<b>Plotters</b> .....	pg. 3-29
<b>Plot without Spurs</b> .....	pg. 3-31
<b>Computed Outputs</b> .....	pg. 4-1

# Param Summary

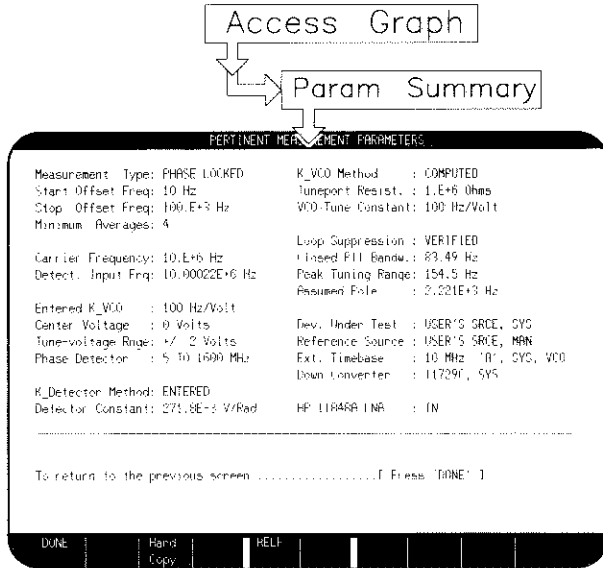

## Introduction

The Parameter Summary lists all of the parameters that are defined for a measurement.

The Parameter Summary is automatically stored and recalled with the Phase or AM Noise Measurement Results as part of a Result File. It is recommended that you include a hard copy of the Parameter Summary with every graph that you output to help when evaluating measurement results.

## Parameter Entry Descriptions

The following is a listing of the parameters included in the summary along with a brief description of each parameter.

**Measurement Type:** This parameter identifies the Measurement Type defined for the measurement. The Measurement Type determines which calibration methods are available and the parameters that are required.

**Start Offset Freq:** This parameter is the minimum offset frequency defined for the measurement in the Type/Range display. This frequency is not necessarily the minimum frequency that will be plotted on the Results Graph. The minimum plotted frequency is set in the Segment Table.

**Stop Offset Freq:** This parameter is the maximum offset frequency defined for the measurement in the Type/Range display. This frequency is not necessarily the maximum frequency that will be plotted on the Results Graph. The maximum plotted frequency is set in the Segment Table.

**Minimum Averages:** This is the minimum number of measurement averages used for the FFT Segments during the measurement. The smoothing of measured data within the FFT Segments is proportional to the square root of the number of averages. For instance, increasing the number of averages by a factor of 4 will cause the results displayed on the graph to be smoothed by a factor of 2.

The segment table also specifies the minimum number of averages for each segment based on measurement time vs. computation time and plot time. The number of averages used by the system for a particular segment is the greater of the two specified minimum average values. (Smoothing for RF Analyzer segments is a function of the Video BW specified in the RF Segment Table.)

**Carrier Frequency:** The Carrier Frequency is used only for labeling the Results Graph, and for the calculation of  $S_y(f)$  and  $\sigma_y(\tau)$  when the HP 11729C Down Converter is not being used.

If the Down Converter is defined to be under system control in the Source Control Diagram, the Carrier Frequency is used to select the proper HP 11729C band as specified in the System Configuration Table. The system also determines the correct IF frequency out of the Down Converter as determined by the Carrier Frequency and HP 11729C band setting.

**Detect. Input Frq:** This is the input frequency to the phase detector as defined for the measurement. It is normally the same value as the Carrier Frequency when a Down Converter is not being used.

If a Down Converter is being used for the measurement, the Detector Input Frequency is the IF output frequency from the Down Converter. The Detector Input Frequency determines which phase detector can be used. At frequencies between 1.2 and 1.6 GHz, either of the internal phase detectors can be used. If the Detector Input Frequency is  $<95$  MHz, then the 2 MHz LPF is enabled after the phase detector and the maximum offset frequency that can be measured is 2 MHz.

**Entered K\_VCO:** This is the VCO Tuning Constant defined for the measurement in the Instrument Parameter display. The Tuning Constant must be estimated to within a factor of 2 of the actual value to optimize the measurement when the HP 3048A is configured to measure the Tuning Constant.

If the Compute from Expected Tuning Constant calibration method is selected, the entry must be accurate to within  $\pm 5\%$  (with respect to the voltage applied to the tune port of the VCO). The VCO tune port input resistance is accounted for in a separate entry.



**Center Voltage:** This is the voltage defined for tuning the VCO to the center of its tuning curve, or to the carrier frequency desired for the measurement. The value of the Center Voltage determines the range of the Tune Voltage possible.

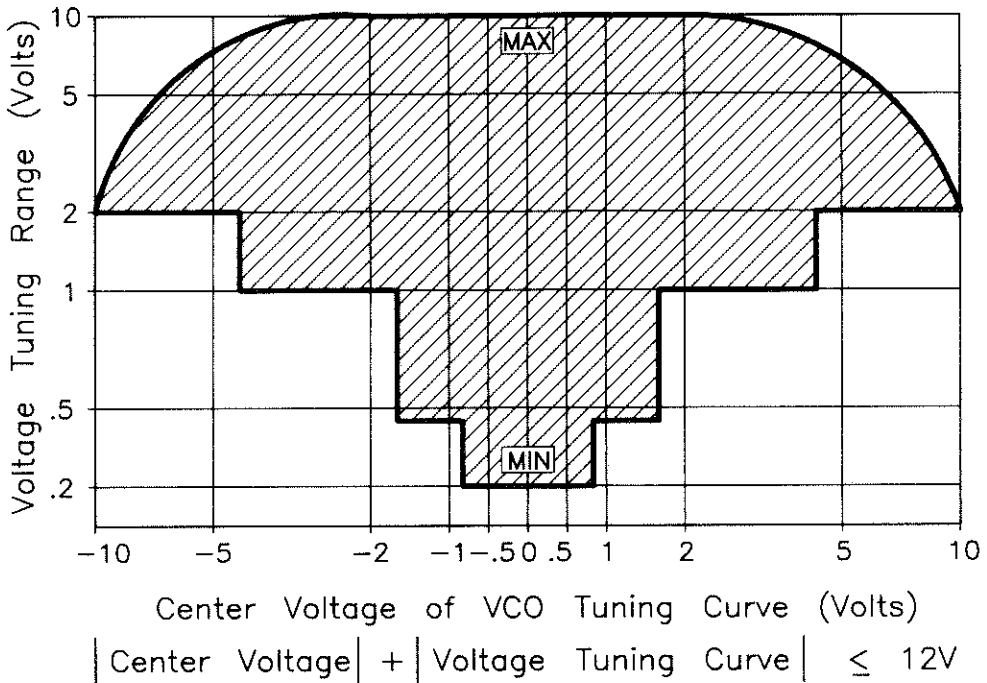

**Figure 3-1. HP 3048A Voltage Tuning Range Limits Relative to the Center Voltage of the VCO Tuning Curve.**

**Tune-voltage Range:** This is the defined Tune Voltage Range through which the system may tune the VCO around the Center Voltage. The VCO output must not change in amplitude by greater than 1 dB, exhibit any reversal in frequency tuning, or be susceptible to damage within the defined Tune Voltage Range around the Center Voltage.

For the system to measure the Tuning Constant accurately, the VCO must tune monotonically across  $\pm 45\%$  of the Voltage Tune Range around the Center Voltage, and the slope must not go to zero. If the VCO Tuning Constant is not measured by the system, the VCO must tune to within  $\pm 10\%$  of the Tune Voltage Range around the Center Voltage using the defined Tuning Constant.

To protect the VCO from possible damage, the Tune Voltage output port should not be connected to the VCO's input port until the Connect Diagram is displayed.

**Phase Detector:** This is the Phase Detector that was defined for the measurement. (For AM and Baseband Noise measurements, the External Phase/AM Detector must be selected in the Instrument Parameter display.)

**K\_Detector Method:** This is the calibration method selected for determining the Phase Detector Constant. (For descriptions of each method for determining the Phase Detector Constant, please refer to *Calibration Process* in the *Measurement Definitions* chapter of this manual.)

**Detector Constant:** This is the Phase Detector Constant (sensitivity of the phase detector) used for the measurement. The accuracy of the Phase Detector Constant is verified if the PLL suppression is verified. The accuracy of the Phase Detector Constant determines the accuracy of the noise measurement.

The Phase Detector Constant value, along with the LNA In/Out parameter, determines the HP 3048A System noise floor exclusive of the reference source. The Phase Detector Constant can be used to approximate the phase detector's R port input level (refer to graph 1 *Approximate HP 3048A Phase Noise Floor vs. R Port Signal Level* in Chapter 7, Quick Reference).

**K\_VCO Method:** This is the calibration method selected for determining the VCO Tuning Constant. If “Measure the VCO Tuning Constant” is selected, the Tuning Constant of the VCO is accurately measured by the system. If the Tuning Constant is not measured, then it is recommended that either the PLL Suppression is verified, the VCO is a calibrated source, or that the Tuning Constant has been verified in a previous measurement.

**Tune port Resist:** This is the Tune Port Resistance as defined in the Instrument Parameter display. The exact Tune Port Resistance is not critical when the system is instructed to measure the VCO Tuning Constant. The Tune Port Resistance is typically 1E+6 when the Tuning Constant is measured. Any correction for the resistance is automatically included in the measurement.

The HP 11848A Tune Voltage Output port has a 50 $\Omega$  internal resistance. The tune voltage output is divided between the 50 $\Omega$  internal resistor and the input resistance of the Tune Port of the VCO. If the selected VCO Tuning Constant calibration method is Compute from Expected T. Constant, the Tune Port Resistance must be accurately defined to correctly calculate the tune voltage output.

**VCO Tune Constant:** This is the VCO Tuning Constant the system used for the measurement. The accuracy of the Tuning Constant determines the accuracy of the PLL noise measurement for offset frequencies greater than or equal to the phase lock loop bandwidth. The accuracy of the Tuning Constant is verified if the PLL Suppression is Verified. The Tuning Constant times the Voltage Tune Range determines the Peak Tune Range (PTR) value for the measurement. The PTR sets the drift tracking and close-in noise suppression capabilities of the system.

**Loop Suppression:** This indicates whether or not the Phase Lock Loop (PLL) Suppression was verified. The PLL Suppression verification verifies the accuracy of the Phase Detector Constant and VCO Tuning Constant.

For all PLL measurements, the system generates a Theoretical Loop Suppression correction and applies it to the measured noise data. When Verification of the Loop Suppression is specified, the system measures the suppression of the phase lock loop and compares the measured suppression to the Theoretical suppression. By adjusting the PTR and the Assumed Pole, the Theoretical suppression is fit to the measured Loop Suppression. If a significant modification is required, the system notifies you of an Accuracy Specification Degradation.

**Acc'y Spec Degrad:** This parameter only appears when Verification of the Loop Suppression is selected, and the Theoretical Loop Suppression must be modified beyond acceptable limits to match it to the measured loop suppression. If the indicated Accuracy Specification Degradation is greater than zero, the VCO Tuning Constant or the Phase Detector Constant is in error at an offset frequency near the PLL BW, or some other problem is effecting the PLL BW, such as injection locking.

Without specific information about the source of the problem, it should be assumed that the accuracy specification for the Results Graph at all offsets has been degraded by the Accuracy Specification Degradation value. That is to say, the specified accuracy of the HP 3048A becomes  $\pm 2$  dB + the Accuracy Specification Degradation for frequencies of 0.001 Hz to 1 MHz, and  $\pm 4$  dB + Accuracy Specification Degradation for frequencies from greater than 1 MHz to 40 MHz. To minimize an Accuracy Specification Degradation, identify and eliminate the probable cause, then initiate a New Measurement with Loop Suppression Verification selected.

**Closed PLL Bandwidth:** This is the predicted Phase Lock Loop Bandwidth (PLL BW) for the measurement. The predicted PLL BW is based on the predicted Peak Tuning Range (PTR) as shown in Figure 3-2. (Note that the predicted PLL BW value is not adjusted when the PTR is adjusted as a result of an Accuracy Specification Degradation.)

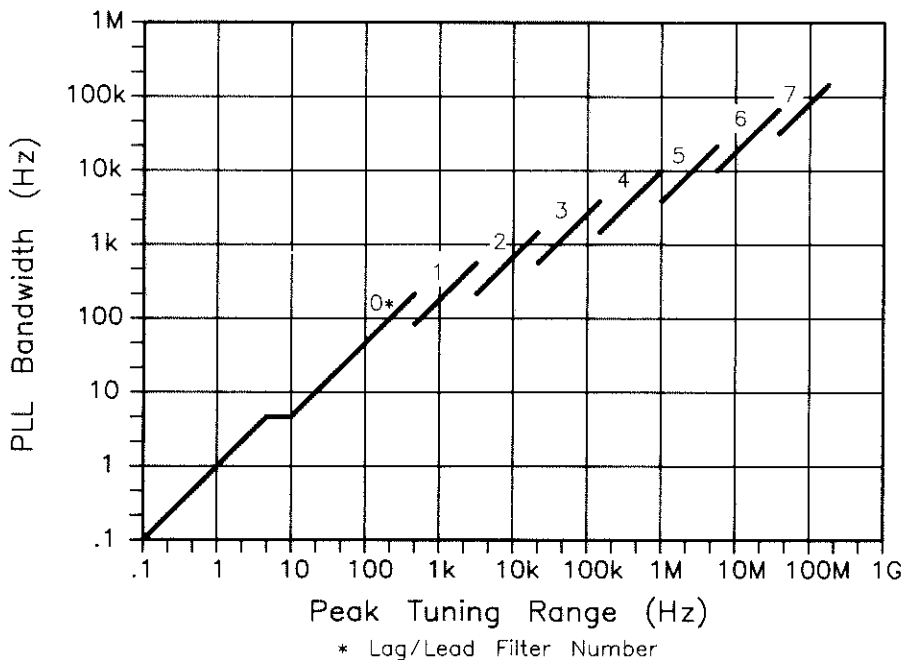

**Figure 3-2. Phase Lock Loop Bandwidth Relative to the Peak Tuning Range.**

**Peak Tuning Range:** This is the Peak Tuning Range (PTR) for the measurement determined from the Tuning Constant and the Voltage Tune Range. This is the key parameter in determining the PLL properties, the Drift Tracking Range, and the ability to phase lock sources with high close in noise.

The PTR value displayed should be approximately equal to the product of the VCO Tune Constant times the Voltage Tune Range. This will not be the case when a significant Accuracy Specification Degradation is detected (> 4 dB) by the Loop Suppression Verification. For Accuracy Specification

Degradations of  $>4$  dB, the PTR and Assumed Pole are adjusted when the Theoretical Loop Suppression is fit to the smoothed measured Loop Suppression. In these cases, the system will not display the adjusted PTR.

Any time the PTR must be adjusted by more than 1 dB (as indicated by an Accuracy Specification Degradation of greater than 0 dB) it is an indication that the Phase Detector Constant or the VCO Tuning Constant will be in error at frequency offsets near the PLL BW, or that the PLL BW is being affected by some other problem such as injection locking.

**Assumed Pole:** This is the frequency of the Assumed Pole required to adjust the Theoretical Loop Suppression to match the smoothed measured Loop Suppression. The Assumed Pole frequency will normally be much greater than the PLL BW.

If the Assumed Pole is adjusted to a frequency of less than  $10 \times$  PLL BW, peaking in the PLL Suppression is indicated. For PLL BWs less than 20 kHz, an Assumed Pole of less than  $10 \times$  PLL BW indicates a delay or phase shift in the VCO Tune Port. For PLL BWs greater than 20 kHz, the Assumed Pole may be adjusted to less than  $10 \times$  PLL BW to account for phase shifts in the HP 11848A.

**Dev. Under Test:** This indicates the device defined as the DUT for the measurement, and how it is being controlled. The DUT cannot be one of the sources listed in the System Configuration Table. You may, however, select one of the HP 11848A internal sources as the DUT.

**Reference Source:** This indicates the device defined as the Reference Source for the measurement, whether or not it is the VCO, and how it is being controlled.

**Ext. Timebase:** This indicates whether or not an External Time Base is being used, and whether it is the VCO for the measurement. (Note that the HP 11848A 10 MHz A and 10 MHz B internal sources can only be operated under system control.)

**Down Converter:** This indicates whether or not a Down Converter is being used in the measurement. If the Down Converter being used is an HP 11729C, an indication is made as to whether it is under system or manual control.

**HP 11848A LNA:** This indicates the state of the Low Noise Amplifier (LNA) the HP 11848A Phase Noise Interface. The LNA is configured either In or Out depending on the output power level of the phase detector. Along with the Phase Detector Constant, the LNA configuration (In or Out) determines the HP 3048A System Noise Floor, exclusive of the reference source.

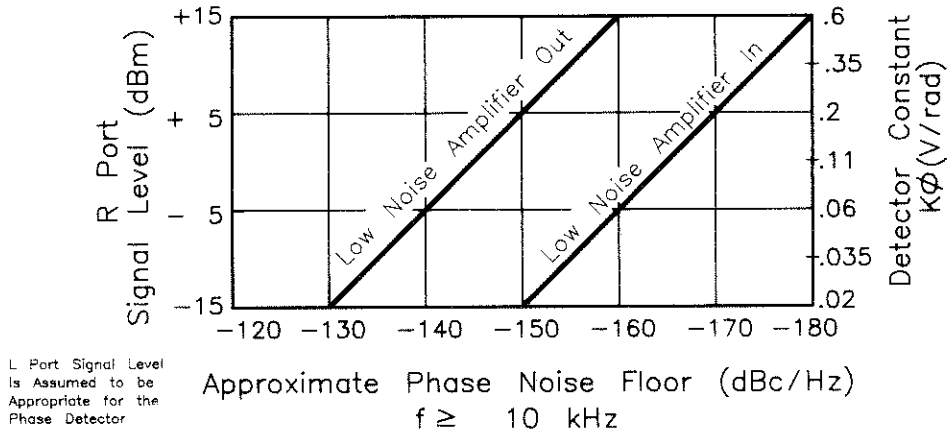

**Figure 3-3. HP 3048A Noise Floor Relative to the Phase Detector Constant and LNA Configuration**

# Result Files

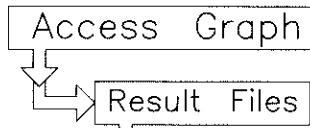

FILES OF MEASUREMENT RESULTS Page 1 of 2

F I L E	N A M E	DATE STORED	STORED AS
350-500 MHZ VCO 8'	DISCRIMINATOR	1 Apr 1987	RESU_11
8656B OVEN OPT VS 8663A	AT 100 MHZ	17 Mar 1987	RESU_2
8662A VS 8662A EFC #1		20 Mar 1987	RESU_6
AM NOISE 8341A	2.6 GHZ	19 Mar 1987	RESU_5
DEFAULT		26 Jan 1987	RESU_1
DISCRIMINATOR		1 Apr 1987	RESU_14
FREE RUNNING RF OSC VS 8640B	5.12 MHZ DC FM	1 Apr 1987	RESU_12
FREE-RUNNING		1 Apr 1987	RESU_13
PLS RES FLR 1.25 %, 2 PLS	MODULATORS	19 Mar 1987	RESU_4
PULSE RESIDUAL FLOOR 50 OHM	TERMINATION	19 Mar 1987	RESU_3

To return to 'ACCESS GRAPH'.....[ Press 'DONE' ]

DONE | Sort | Load | Next | HELP | Mass | Read | Update | Delete | Store  
 Files | File | Page | Storage | Dir. | Dir. | File | File

## Introduction

Result Files contain data from a completed noise measurement or computation and the associated Parameter Summary. The location of the Test Result File is specified in the Mass Storage Table.



## Description

A Result File should be stored any time a permanent record of the results is required, such as for verification of performance testing during calibration, or when a "3 Oscillator Comparison" is performed.

The HP 3048A is shipped with a "Default" Result File on the System Data Disc. This Result File contains phase noise measurement data for the HP 11848A Internal 10 MHz sources (10 MHz A vs. 10 MHz B). This default measurement data is provided to allow you to quickly verify system operation by comparing your measurement of A vs. B to the results obtained at the factory prior to shipment.

---

### NOTE

Any file stored as the Default Result File will be automatically loaded. The system automatically loads the Default Result File when the software is loaded, or if the System Preset softkey is pressed.

---

## Softkey Descriptions

**Sort Files:** Lists the files in alphanumeric order instead of chronological order.

**Load File:** Recalls and loads the Result File specified by the cursor's position in the list.

**Next Page:** Accesses the following pages of the Result File Directory. This softkey only appears if there are more than 10 file entries listed.

**Mass Storage:** Accesses the Mass Storage Media display. The locations of the System files are defined in the Mass Storage Media display. Defining the Mass Storage Media allows you to store or load Result Files from various mass media locations.

**Read Dir.:** Accesses the Result File Directory at the location specified in the Mass Storage Media display. This allows you to read the directory of any disc or media that contains Result Files by inserting a new disc, or changing the Mass Storage Media location for "Test Result Files".

**Update Dir.:** Allows you to re-label a Result File. Position the cursor at the Result File you wish to re-label, then type in the new label over the old label. Press the Update Dir. softkey to assign the new label to the specified Result File, and to re-list the files in alphabetical order.

**Delete File:** Removes the Result File indicated by the cursor position and re-lists the directory without the deleted file.

**Store File:** Stores a Result File onto the specified Mass Storage Media. The Result File contains the measurement results and the Parameter Summary currently stored in memory.

## Consideration for Result Files

Copying the Result Files using copy routines provided in the Basic Operating System will not update the Result File Directory and may cause loss of data. Copy Result Files from one disc to another by loading the Result File into the System and then Storing the Result File on to the other disc.

When loading a result file, be certain you have specified the correct graph type for the file being loaded. For instance, if you have selected the graph type for a Phase Noise Using PLL measurement, and then you load a result file for an AM Noise measurement, an error message is displayed to alert you to the condition.

When a Result File is loaded, the Carrier Frequency parameter entered into the Instrument Parameter display is not changed. If you plan to compute Sigma vs. Tau for the loaded Result File, first verify that the defined Carrier Frequency is appropriate for the loaded file. An incorrect Carrier Frequency entry will produce invalid Sigma vs. Tau computations. (Carrier Frequency is the only measurement parameter that is used for the Sigma vs. Tau computation).

The "Resu\_" numbers represent the media file name and the order in which the Result Files were stored.

## Storing a Result File

Once a measurement is completed and the Results Graph is displayed, you can store the measurement data in a Result File. The following steps describe the storing process.

1. Press the **Result Files** softkey to access the Result File Directory display.
2. Move the cursor to the bottom of the File Name column. (If the page is full, press **Next Page** to access a page with available entry space.)

---

### NOTE

It is possible to lose data when using a hard disc or SRM Mass Storage Device for storing the Result Files. If you attempt to store more than 99 Result Files on one media, the HP 3048A will destroy previously stored Result Files.

Disc storage is usually limited to approximately 50 Result Files per disc.

- 
3. Enter a name for the file. The HP 3048A will allow 47 characters in the File Name column.
  4. Press the **Store File** softkey. The Result File will be stored in the Mass Storage Media location defined for "Test Result Files".

## Loading a Result File

The following steps describe the procedure for loading a previously stored Result File.

1. Press **Access Graph** if you are at the Main Software Level.
2. Press **Result Files** to access the Result File Directory.
3. Position the cursor at the file you wish to load. (Press **Next Page** to access the following pages, if necessary.)

---

### NOTE

The measurement data currently in memory will be overwritten when you load a Result File.

---

4. Once you have positioned the cursor at the file you wish to load, press the **Load File** softkey.
5. After the file has been loaded, press **Done** to exit the Result File Directory.
6. Press the **Redraw Graph** softkey to display the measurement data from the Result File just loaded.

## Creating a Directory

The following steps describe the procedure for creating a new Result File Directory (Parm\_Dir).

1. Define the location of the "Test Result Files" in the Mass Storage Media Table.
2. Press the **Create Dir** softkey when the error message appears. (The error message indicates the HP 3048A has attempted to load the Parm\_Dir from the new media and has determined that a Directory has not yet been created.)
3. Press the **Fixed** softkey to continue. Result Files can now be stored on the new Mass Storage Media.

When the HP 3048A System software is shipped to the customer it includes several predefined Test Files. These Test Files allow you to perform the required Performance Test exactly how the Factory test the System. Also included are Test Files of specific examples defined in the HP 3048A Operating Manual and a Default Test that allows you to quickly verify the operation of the System and build confidence in the measurement process. The Test Files included in the Data Disc when shipped are:

**Default** sets up the System to measure the HP 11848A Internal 10 MHz Sources. (10 MHz A vs. 10 MHz B). This measurement quickly verifies the Systems ability to measure Phase Noise. The results for this measurement may be compared with the Default Result File also stored on the Data Disc.

Any Test File named "Default" at the location "Test Parameter Files" specified in the Mass Storage Media table will be loaded automatically every time the HP 3048A Software is loaded or the **System Preset** is pressed.

# Define Graph

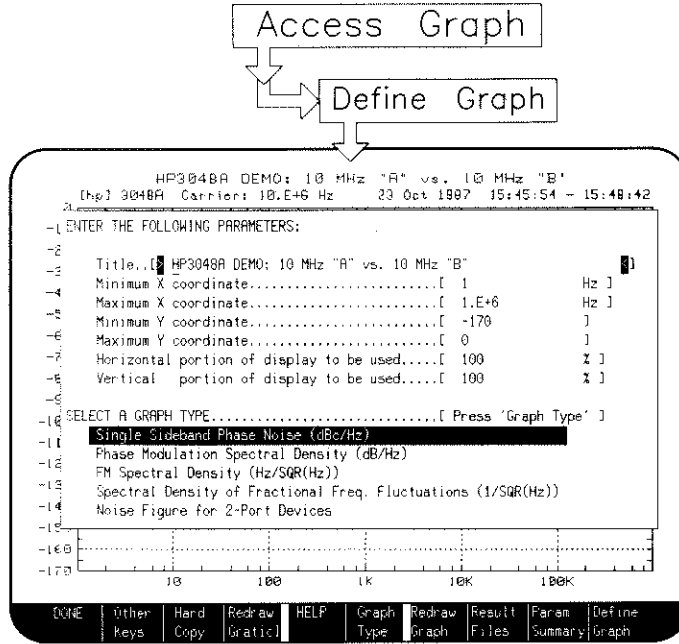

## Introduction

The Define Graph display allows you to specify the Measurement Results graph characteristics. The graph title, X axis range, Y axis range, and graph type for the graph are defined in this display.

## Parameter Entry Descriptions

**Title:** This parameter allows you to enter a title for the Results Graph (up to 58 characters long).

**Minimum X Coordinate:** This parameter specifies the start value (frequency) for the X axis on the graph. The entry can be in integer or exponential form. The acceptable limits are 1.E-3 Hz. to 10.E+9 Hz. This value must be less than the Maximum X coordinate.

**Maximum X Coordinate:** This parameter specifies the stop frequency for the X axis on the graph. The entry can be in integer or exponential form. The acceptable limits are 1.E-3 Hz. to 10.E+9 Hz. This value must be greater than the Minimum X coordinate.

**Minimum Y Coordinate:** This parameter specifies the upper limit of the Y axis. The entry can be in integer or exponential form. The acceptable limits are displayed on the screen. Units for the Y axis are determined by the Graph Type selected. This value must be less than the Maximum Y coordinate.

**Maximum Y Coordinate:** This parameter specifies the lower limit of the Y axis. The entry can be in integer or exponential form. The acceptable limits are displayed on the screen. Units for the Y axis are determined by the Graph Type selected. This entry must be greater than the Minimum Y coordinate.



**Horizontal Portion of the Display to be Used:** This parameter allows you to specify the percentage of the horizontal display area you want to use for displaying plots.

If you are using a large high-resolution monitor and you want to print out a plot, part of the display's output may be ignored by a printer with less horizontal printing capability than shown on your display. Specifying a smaller amount of the display to be used for the plot allows the printer to print all of the plot shown on your display.

For instance, if you are using an HP 98785A monitor with a Model 350 computer and a PaintJet Printer, using a horizontal scale of 70% and a vertical scale of 53% allows the entire result plot to be printed.

The new graph size is not displayed until Redraw Graph or Redraw Graticule is pressed.

**Vertical Portion of Display to be Used:** This parameter allows you to specify the percentage of the vertical display area you want to use for displaying plots.

If you are using a large high-resolution monitor and you want to print out a plot, part of the display's output may be ignored by a printer limited to fewer vertical lines of resolution than the computer display. Specifying a smaller amount of the display to be used for the plot allows the printer to print all of the plot shown on your display.

For instance, if you are using an HP 98785A monitor with a Model 350 computer and PaintJet Printer, using a horizontal scale of 70% and vertical scale of 53% allows the entire result plot to be printed.

The new graph size is not displayed until Redraw Graph or Redraw Graticule are pressed.

**Graph Type Other than AM or Baseband Noise:** This parameter specifies the data type in which the measurement results will be displayed.

- **Single-sideband phase noise (dBc/Hz).** The HP 3048A computes  $\mathcal{L}(f)$  as:  $\int_{f_1}^{f_2} \frac{S_\phi(f)}{2} df$ , and plots the results in dBc.
- **Phase Modulation Spectral Density (dB/Hz).** The HP 3048A computes  $S_\phi(f)$  as:  $\int_{f_1}^{f_2} S_\phi(f) df$ , and plots the results in dB with respect to 1 radian (Radians, and Degrees).
- **FM Spectral Density (Hz/ $\sqrt{Hz}$ ).** The HP 3048A computes  $S_\nu(f)$  as:  $\int_{f_1}^{f_2} S_\phi(f) \times f^2 df$ , and plots the results in Hz (Residual FM).
- **Spectral Density of Fractional Frequency Fluctuations (1/ $\sqrt{Hz}$ ).** The HP 3048A computes  $S_y(f)$  as:  $\int_{f_1}^{f_2} S_\phi(f) \times \left(\frac{f}{f_{carrier}}\right)^2 df$ , and plots the results without units.
- **Noise Figure for 2-Port Devices.** The HP 3048A computes the noise figure (NF) as:  $S_\phi(f) + 174 + Pin$ , and plots the results as dB/Hz. Pin is the input power listed in the Computed Output "Input Power at Amplifier..." field.

## Consideration for Defining the Results Graph

The HP 3048A will complete a measurement even though the ranges defined for the measurement are incorrect. Graph characteristics can be changed when the Measurement Results are displayed after the measurement is complete.

## Marker ON/OFF

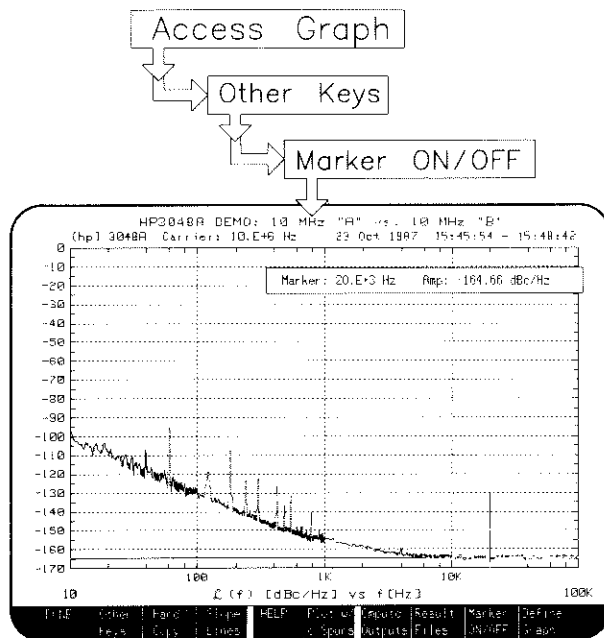

## Introduction

The Marker function allows you to read the amplitude and frequency of the displayed noise or spur level at a discrete point. The Marker is accessed by pressing the **Marker ON/OFF** softkey that appears in the Graphics Display. The marker can be positioned using the right and left direction keys or the control knob.

The Marker can be included on a printer hardcopy by pressing **Hard Copy** with the Marker function on. The Marker can be included on a plotter hardcopy by pressing **SHIFT Plot Data** with the Marker function on.

## Description

The Marker's resolution is a function of the measurement span defined in the FFT and RF Segment Tables. Because each span for a particular analyzer contains the same number of data points, narrower spans provide better resolution than do wider spans. The following table lists the number of data points per span for supported analyzers.

<b>Model</b>	<b>Data Points Per Frequency Span</b>
HP 3561A	401
HP 3585A/B	1001
HP 8562A/B	601
HP 8566A/B	1001
HP 8568A/B	1001
HP 71000	801

# Slope Lines

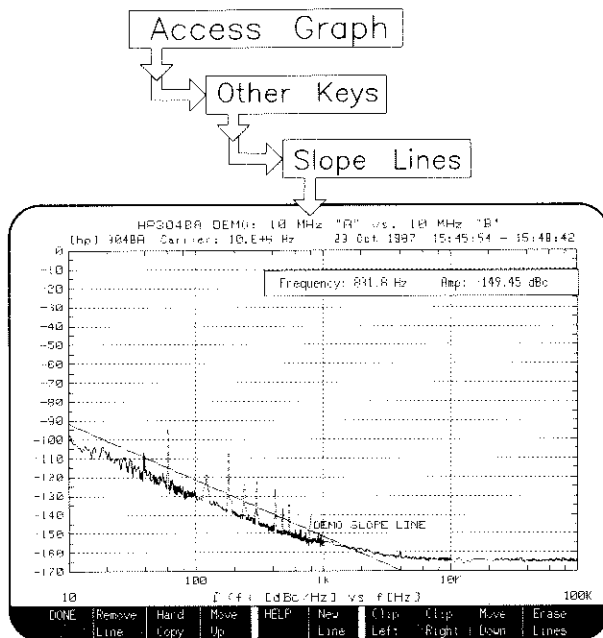

## Introduction

The Slope Line function allows you to position lines on the display for estimating the slope of the measured noise data. These lines can be outputted to a printer along with the Results Graph.

## Softkey Descriptions

**Remove Line:** Erases the line currently indicated by the position of the cursor.

**Hard Copy:** Outputs the current display to the printer. **SHIFT** Hard Copy outputs the display and the current Parameter Summary to the printer.

**Move Up:** Moves the Slope Line up. The cursor must be positioned on the line to be moved.

**New Line:** Enables you to position a Slope Line. The knob and arrow keys rotate the displayed line through 360 degrees.

**Set Line:** Sets the currently defined Slope Line. Once a line is set, it can be modified (Move Up/Down, Clip Right/Left) and labeled.

**Clip Left:** Removes the portion of the Slope Line to the left of the cursor. The cursor must be positioned on the Slope Line and to the left of any intersections with other slope lines.

**Clip Right:** Removes the portion of the Slope Line to the right of the cursor. The cursor must be positioned on the Slope Line and to the right of any intersections with other slope lines.

**Move Down:** Moves the Slope Line down. The cursor must be positioned on the line to be moved.

**Erase Lines:** Removes all of the Slope Lines from the display.

**Help:** Accesses the help text for the Slope Line function. **SHIFT** Help opens the Label window for labeling a Slope Line. Labels can contain up to 40 characters. Press **SHIFT** Help again to close the Label window.

## Considerations for the Slope Lines Function

Slope Lines can be stored in a Result File by storing the file after the Slope Lines have been defined.

Slope Lines can be output to a printer, but not to a plotter.

The slope of the line can be incremented (or decremented) in 1 dB steps between  $\pm 100$  dB/decade. The resolution along the Slope Line is a function of the measurement spans set in the FFT and RF Segment Tables.

If you wish to set a Specification Line (reference) rather than a Slope Line, refer to *Define Graph* in Chapter 2, *Measurement Definitions*.

## How to Create Slope Lines

The following steps describe the procedure for creating and modifying Slope Lines.

1. Press the **New Line** softkey to create a Slope Line. Use the knob and arrow keys to rotate the Slope Line in  $\pm 1$  dB increments. (Beyond  $\pm 100$  dB/decade, the Slope Line steps to a Vertical position.) The slope of the line is displayed in the slope window.
2. Once the slope is in the desired position, press the **Set Line** softkey.
3. After the Slope Line has been set, it may be modified using the Move up, Move Down, Clip left, or Clip Right softkeys.

## How to Label Slope Lines

The Slope Line label window is accessed by pressing the **SHIFT** **Help** softkey. This opens a window that allows a keyboard entry of up to 40 characters to describe the line. Exit the label window by pressing **SHIFT** **Help** softkey again.

# Plotters

## Introduction

The HP 3048A outputs the displayed graphics to the plotter. A Plotter offers better resolution and allows use of colors for designating such things as noise versus spurs, or multiple measurement results. (Plotter Pen selection is provided at the System Configuration Display.) The HP 3048A only supports HP-GL Plotters.

## Softkey Descriptions

**SHIFT** Redraw Graph outputs the current display to a plotter.

**SHIFT** Plot Data is only the noise curve to a plotter. This function is used to plot several noise curves on the same graticule.

**SHIFT** Plot w/o Spurs outputs the noise curve without the spurs.

## Considerations for Plotting Data

Slope Lines cannot be plotted. Specification Lines can be defined in such a way as to simulate Slope Lines. If you wish to output specified lines on the plotted graph, refer to *Define Graph Chapter 2, Measurement Definition* for details on Specification Lines.



## Plot w/o Spurs

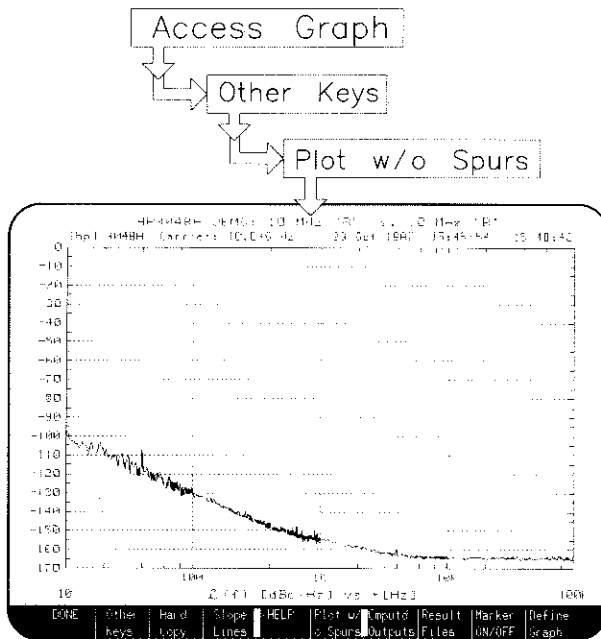

## Introduction

The Plot Without Spurs function plots the measured noise data excluding the recognized spurs. This feature is helpful when evaluating the noise data at an offset frequency cluttered by a forest of spurs. The system uses an elaborate algorithm to remove the spurs and replace that area with continuous data.

## Description

The Plot without Spurs graphic function replots the noise data on the current graticule. Therefore, to eliminate the spurs of the current measurement results you must first press the **Redraw Gratic** softkey to create a new graticule, then press the **Plot w/o Spurs** softkey to display the noise data on the new graticule.

To output the noise data without spurs to a Plotter press the SHIFT **Plot w/o Spurs** softkey.

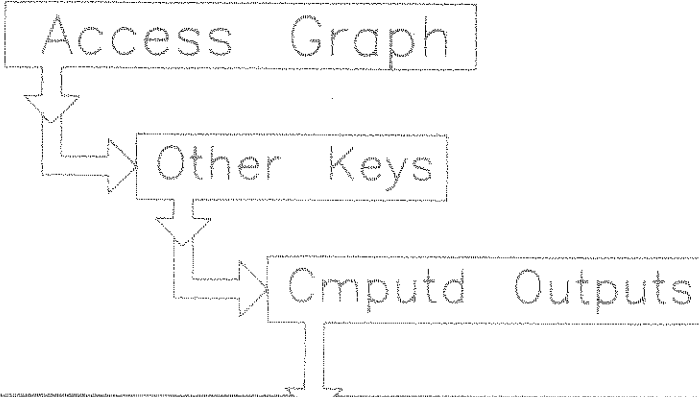

COMPUTED FORMAT OF TEST RESULTS

To perform Sigma vs. Tau (Allen var.) computations....[ Press 'Sigma vs. Tau' ]  
 To list spurs in a specified offset-frequency range...[ Press 'Spur List' ]  
 To subtract a known ref. osc. from a measurement.....[ Press '2 Osc. Compar.' ]  
 To solve for 3 unknown osc. using 3 measurements.....[ Press '3 Osc. Compar.' ]  
 To integrate (sum) the noise of the last measurement..[ Press 'Integr. Noise' ]

---

The following parameters modify only the PLOTTED representation of the data.

Normalize data to a [ 1 ] Hz bandwidth. ('0' Hz omits normalization.)  
 Scale data to new carrier freq defined as: 10.E+6 Hz \* [ 1 ]  
 Shift all data (including spurs) DOWN by.....[ 0 ] dB  
 Input power at amplifier for Noise Figure computation.....[ 0 ] dBm

Acceptable Values: 0 TO 10.E+6

No test-result data exists in memory.

To return to 'ACCESS GRAPH'.....[ Press 'DONE' ]

DONE	Integr Noise	Sigma vs. Tau	HELP		Spur List	2 Osc. Compar.	3 Osc. Compar.
------	-----------------	------------------	------	--	--------------	-------------------	-------------------

# Computed Outputs

---

# 4

## Introduction

The Computed Outputs are the output functions available after the completion of a noise measurement. These outputs are derived from the data currently in memory.

<b>Integrated Noise</b> .....	pg. 4-3
<b>Sigma vs. Tau</b> .....	pg. 4-9
<b>Normalized Bandwidth</b> .....	pg. 4-15
<b>3 Osc. Comparison</b> .....	pg. 4-19
<b>2 Osc. Comparison</b> .....	pg. 4-23
<b>Spur List</b> .....	pg. 4-27
<b>Spur List</b> .....	pg. 4-27
<b>Phase Jitter in the Frequency Domain</b> .....	pg. 4-29
<b>Scale Data</b> .....	pg. 4-33
<b>Shift Data</b> .....	pg. 4-35
<b>Input Power at Amplifier</b> .....	pg. 4-37

# Integr Noise

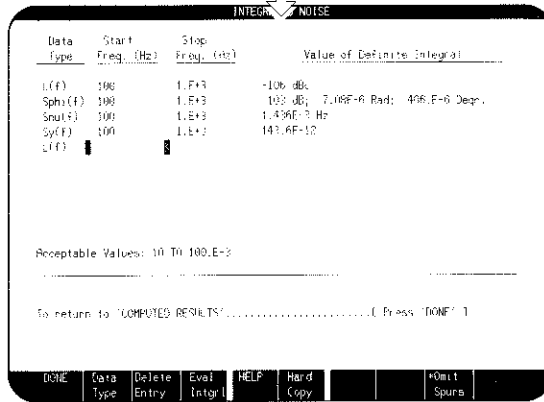
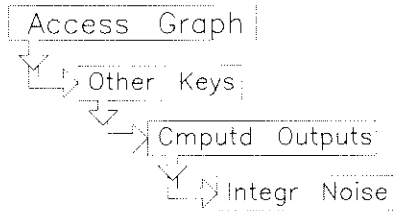

## Introduction

The Integrated Noise function integrates the selected noise type between specified start and stop frequencies. (Integrated noise is defined as the rms modulation in a frequency band.)

The HP 3048A computes the Definite Integral Value between two specified frequencies in which continuous data exists. The integration is computed on the noise data currently in memory. The computation is only as accurate as the measurement data being integrated. (The *Evaluating the Results* Chapter of the Operating Manual provides help in verifying your measurement results.)

The Integrated Noise feature allows you to include or omit the detected spurs in the calculation. Detected spurs are not integrated as noise, but they are included in the calculation as discrete power additions.

## Softkey Descriptions

**Data Type:** Specifies the result for the Definite Integral.

**Delete Entry:** Removes the row currently defined by the cursor.

**Eval Intgrl:** Initiates the Definite Integral solution.

**\*Omit Spurs:** Initiates the Definite Integral solution without the addition of the spurs. This will solve for only the noise power of the measurement data and not the power contributed by the spurs.

## Parameter Entry Descriptions

### Data Type

$\mathcal{L}(f)$ : Single-sideband phase noise. Selecting  $\mathcal{L}(f)$  instructs the system to solve  $\int_{f_1}^{f_2} \frac{S_\phi(f)}{2} df$  in dBc.

$S_\phi(f)$ : Spectral density of phase fluctuations. Selecting  $S_\phi(f)$  instructs the system to solve  $\int_{f_1}^{f_2} S_\phi(f) df$  in dB with respect to 1 radian (Radians, and Degrees).

$S_\nu(f)$ : Spectral density of frequency fluctuations. Selecting  $S_\nu(f)$  instructs the system to solve  $\int_{f_1}^{f_2} S_\phi(f) \times f^2 df$  in Hz (Residual FM).

$S_y(f)$ : Spectral density of fractional frequency fluctuations. Selecting  $S_y(f)$  instructs the system to solve  $\int_{f_1}^{f_2} S_\phi(f) \times \left(\frac{f}{f_{carrier}}\right)^2 df$  (without units).

## **Start Freq. (in Hz)**

The system allows you to enter a start frequency within the range of the measured data. The (Acceptable Value) range is displayed in the lower left portion of the HP 3048A's display.

## **Stop Freq. (in Hz)**

The system allows you to enter a stop frequency within the range of the measured data. The (Acceptable Value) range is displayed in the lower left portion of the HP 3048A's display.

## **Minimum Range of Integration**

### **Frequency offsets $\leq$ 100 kHz**

To measure frequency offsets less than or equal to 100 kHz, the HP 3048A uses the HP 3561A FFT Dynamic Signal Analyzer. The minimum frequency resolution of the HP 3561A is equal to its frequency span divided by 400. Each of the 400 increments is called a Bin. The HP 3048A cannot integrate less than 1 Bin. To determine the resolution of 1 Bin, divide the frequency span by 400. The HP 3561A's frequency span is defined in the FFT Segment Table.

$$\text{Minimum range of Integration} = 1 \text{ Bin} = \frac{\text{HP 3561A Frequency Span}}{400}$$

**For example:** A frequency span setting on the HP 3561A of 100 Hz will provide 0.25 Hz of resolution for each Bin. Therefore, the minimum frequency range you can specify for integration is 0.25 Hz in the frequency range where the data from the 100 Hz span is plotted.

## Frequency offsets > 100 kHz

The HP 3048A System supports a number of RF Spectrum Analyzers for measuring frequency offsets greater than 100 kHz. The minimum frequency resolution of any RF analyzer is determined from the frequency span selected to make the measurement. Systems with an RF analyzer cannot integrate less than their frequency resolution, or the interval between two consecutive data points within the frequency span. RF analyzers typically have approximately 1000 data points per span. (Table 4-1. shows the intervals per frequency span for several RF analyzers supported by the HP 3048A.) The minimum range of integration is greater than or equal to the selected frequency span divided by the total number of data points (1000) within the span. The frequency span and resolution is defined in the RF Segment Table.

$$\text{Min. Range of Integration} = \frac{\text{RF Analyzer Frequency Span}}{\text{Intervals Per Frequency Span}}$$

**For example:** The HP 3585A RF analyzer uses 1000 data points for each frequency span. A span setting of 500 kHz will provide 500 Hz of resolution between data points. Therefore, the minimum frequency range you can specify to integrate is 500 Hz for a 500 kHz setting.

**Table 4-1. Table of Data Points for Supported Analyzers**

Model	Data Points Per Frequency Span	Intervals Per Frequency Span	Minimum Range of Integration
HP 3561A	401	400	Freq. Span $\div$ 400
HP 3585A	1001	1000	Freq. Span $\div$ 1000
HP 8562	601	600	Freq. Span $\div$ 600
HP 8566A/B	1001	1000	Freq. Span $\div$ 1000
HP 8568A/B	1001	1000	Freq. Span $\div$ 1000
HP 71000	801	800	Freq. Span $\div$ 800



## Description

### How Does the HP 3048A Compute Integrated Noise?

The software routine begins by storing the marked spurs within the specified start and stop frequency range. The marked spurs are then removed from the noise data. (A linear connection is made between the data points in the area where each spur was removed.) The remaining measured noise data is converted to noise power and integrated between the specified start and stop frequencies. When the integration is complete, the marked spurs are added to the integrated noise as discrete powers. The Definite Integral solution is then displayed for the Data Type selected.

The Definite Integral Value is computed by the HP 3048A using the following summation:

$$\sum_{i=a}^b G_{power(f_i)} \times Hz/Bin$$

where :  $f_i$  = frequency from 'a' (start) to 'b' (stop)  
 $Bin$  = Analyzer span resolution.

and :

$$\begin{aligned} G_{power(f_i)} &= \left[ \frac{10^{\frac{S_{\phi}(f_i)}{10}}}{2} \right] \text{ for } \mathcal{L}(f). \\ &= \left[ 10^{\frac{S_{\phi}(f_i)}{10}} \right] \text{ for } S_{\Phi}(f). \\ &= \left[ 10^{\frac{S_{\phi}(f_i)}{10}} \times f_i^2 \right] \text{ for } S_{\nu}(f). \\ &= \left[ 10^{\frac{S_{\phi}(f_i)}{10}} \times \left( \frac{f_i}{\text{carrier freq.}} \right)^2 \right] \text{ for } S_y(f). \end{aligned}$$

## Considerations for Computing Integrated Noise

**Unable to Integrate Over Non-contiguous Data** This message appears on the display if the measured noise data is non-contiguous over the range defined for the integration. The system cannot solve the Definite Integral over non-contiguous data. Any gaps (missing data) between the specified start and stop frequencies prevent the system from solving the Definite Integral. Examine the measured data within the noise graph for breaks or missing segments within the specified range of integration. Re-enter the start and stop frequencies so that the specified range contains only contiguous data.

**Span Too Narrow Cannot Integrate** This message will appear if the frequency range specified for integration is smaller than the resolution of the analyzer (as defined in the FFT and RF Segment Tables). Re-enter the start and stop frequencies to specify a wider range to be integrated, or redefine the segment tables for more resolution and initiate a new measurement of the DUT. (For information on modifying the segment table, refer to *FFT Segmnts* or *RF Segmnts* in Chapter 5, Special Functions.)

If you wish to calculate the noise in a bandwidth less than the resolution of the data (other than 1 Hz), either:

- Plot the data in the desired bandwidth first (refer to *Normalized Bandwidths* in Chapter 4, Computed Outputs for details), or
- Calculate the noise of the frequency offset in the desired bandwidth by adding  $10 \log$  (desired bandwidth) to the measurement noise level.

# Sigma vs. Tau

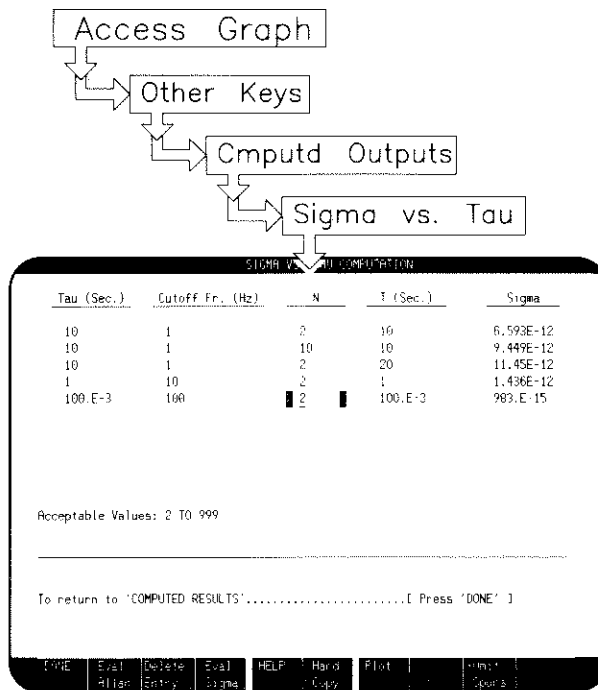

## Introduction

The Sigma vs. Tau function calculates fractional frequency deviation ( $\sigma$ ) as a function of averaging time or measurement time ( $\tau$ ) over the range of  $\tau$  permitted by the available phase noise data. This calculation requires that parameters  $N$ ,  $T$ , and  $f_h$  (cutoff frequency) be specified.

- **N** is the number of frequency averages used to compute the mean frequency for the calculation of  $\sigma$ .
- **T** is the total time period (dwell plus samples).
- $\tau$  (tau) is the averaging time selected (sample time, measurement time).
- **Cutoff Fr.** ( $f_h$ ) is the measurement system bandwidth.

Allan Variance is the fractional frequency deviation versus the averaging time when  $N = 2$  and  $T = \tau$ . This section describes the process used by the HP 3048A to calculate sigma of  $\tau$  and the Allan Variance.

## Softkey Descriptions

**Eval Sigma:** Initiates the calculation of Sigma when  $N$ ,  $T$ ,  $\tau$ , and  $f_h$  are specified.

**Eval Allan:** Calculates Sigma when  $\tau$  and  $f_h$  are specified.

**\*Omit Spurs:** Calculates Sigma excluding the spur contributions for the specified entries.

**Plot:** Plots all calculated Sigma on a Sigma versus Tau graph.

## Description

### Sigma vs. Tau

The following equations define fractional frequency deviation versus averaging time.

$$\sigma_y^2(N, T, \tau, f_h) = \left\langle \frac{1}{N-1} \sum_{h=1}^N (\bar{Y}_h - \frac{1}{N} \sum_{k=1}^N \bar{Y}_k)^2 \right\rangle$$

where:  $f_h = \text{noise bandwidth}$

and:  $\langle \rangle \equiv \text{infinite time average}$

where:  $\bar{Y}_k = \frac{1}{\tau} \int_{t_k}^{t_k+\tau} Y(t) dt = \frac{\Phi(t_k+\tau) - \Phi(t_k)}{2\pi\nu_0\tau}$

and:  $Y_k \equiv \text{average frequency over } K\text{th time interval of length } \tau$   
(as would be determined by a high resolution counter)

---

## NOTE

The Sigma vs. Tau function uses the Carrier Frequency defined in the Instrument Parameters display for its computation. If Sigma vs. Tau is being computed for a Result File loaded from memory, be sure that the same Carrier Frequency used for the measurement is entered into the Instrument Parameters display.

---

### Allan Variance <sup>1</sup>

David Allan of the National Bureau of Standards recognized that  $\sigma_y^2(\tau)$  is also a function of N and T for some noise processes. Therefore, he proposed the following:

Let  $N = 2$ ,  $T = \tau$ , Allan Variance =  $\sigma_y^2(2, \tau, \tau, f_h) = \sigma_y^2(\tau, f_h)$

$$\langle \sigma_y^2(\tau, f_h) \rangle = \left\langle \frac{(\bar{Y}_{k+1} - Y_k)^2}{2} \right\rangle$$

Cutler<sup>2</sup> has shown that:

$$\langle \sigma_y^2(N, T, \tau, f_h) \rangle = \frac{N}{N-1} \int_0^{f_h} S_y(f) \frac{\sin^2(\pi f \tau)}{(\pi f \tau)^2} \left[ 1 - \frac{\sin^2(\pi N f T)}{N^2 \sin^2(\pi f T)} \right] df$$

---

<sup>1</sup> D. W. Allan, "Statistics of atomic frequency standards," Proc. IEEE, vol. 54, pp. 221-230, February 1966.

<sup>2</sup> L. Cutler and C. Searle, "Some aspects of the theory and measurement of frequency fluctuations in frequency standards," Proc. IEEE, vol. 54, pp. 135-154, February 1966.

where :  $S_y(f) = \frac{f^2}{v_0^2} S_\Phi(f)$

This equation is numerically integrated in the HP 3048A software. The lower limit of integration, 0, is replaced by the minimum offset frequency for which there is data in memory ( $f_{min}$ ). Because arbitrarily low frequency data is not available, the maximum possible  $\tau$  for which  $\sigma(\tau, f_h)$  can be computed is  $\tau_{max} = \frac{1}{5f_{min}}$ .

The upper limit of integration ( $f_h$ ) is specified by the user based on the actual bandwidth of the system in which he tests or uses the particular device for which  $\sigma_y(\tau)$  is being calculated.

Depending on the dominant slope of the phase noise at offsets 1 decade above and below  $\frac{1}{2\tau}$ , the maximum value of  $\tau$  for which an accurate computation of  $\sigma$  can be made and can be chosen as shown in Table 4-2.

**Table 4-2. Slope versus Maximum Tau**

Slope of $\mathcal{L}(f)$ or $S_\Phi(f)$	Maximum $\tau$ for data to $f_{min}$	$f_h$
-50 dB/decade	*	*
-40 dB/decade	$\tau \leq \frac{1}{10f_{min}}$	$\frac{10}{\tau}$
-30 dB/decade	$\tau \leq \frac{1}{5f_{min}}$ **	$\frac{10}{\tau}$
-20 dB/decade	$\tau \leq \frac{1}{5f_{min}}$ **	$\frac{10}{\tau}$
-10 dB/decade	$\tau \leq \frac{1}{5f_{min}}$ **	As appropriate
0 dB/decade	$\tau \leq \frac{1}{5f_{min}}$ **	As appropriate
* Calculation not recommended. Will not be accurate unless there is a region of shallower slope below the 50 dB/decade region. ** System Default.		

Table 4-3 shows the relationship of  $\mathcal{L}(f)$  to Allan Variance for a power low-noise process. Using this table, an estimate of  $\sigma_y(\tau)$  can be made directly from a phase noise plot.

**Table 4-3. Relation of  $\mathcal{L}(f)$  to Allan Variance**

	Slope of $\mathcal{L}(f)$ (dB/decade)	$\sigma_y(\tau) =$
White Phase	0	$\frac{\sqrt{\mathcal{L}(f)f_h}}{2.565\nu_o} \tau^{-1}$
Flicker Phase	-10	$\frac{\sqrt{\mathcal{L}(f)f(2.184 + \ln(f_h\tau))}}{2.565\nu_o} \tau^{-1}$
White Freq.	-20	$\frac{\sqrt{\mathcal{L}(f)f^2}}{\nu_o} \tau^{-\frac{1}{2}}$
Flicker Freq.	-30	$\frac{1.665\sqrt{\mathcal{L}(f)f^3}}{\nu_o} \tau^0$
Random Walk Freq.	-40	$\frac{3.63\sqrt{\mathcal{L}(f)f^4}}{\nu_o} \tau^{\frac{1}{2}}$

$\tau$  = measurement time,  $y = \Delta\nu/\nu_o$ ,  $\nu_o$  = carrier frequency,  $f$  = modulation rate or offset frequency,  $f_h$  = measurement system bandwidth,  $y = \frac{\Delta\nu}{\nu_o} \nu_o$

---

### NOTE

Frequency  $f_h$  is specified as the measurement system bandwidth to minimize computation time. You may wish to determine the smallest  $f_h$  for a given  $\tau$  that will provide accurate results.

---

# Normalized Bandwidth

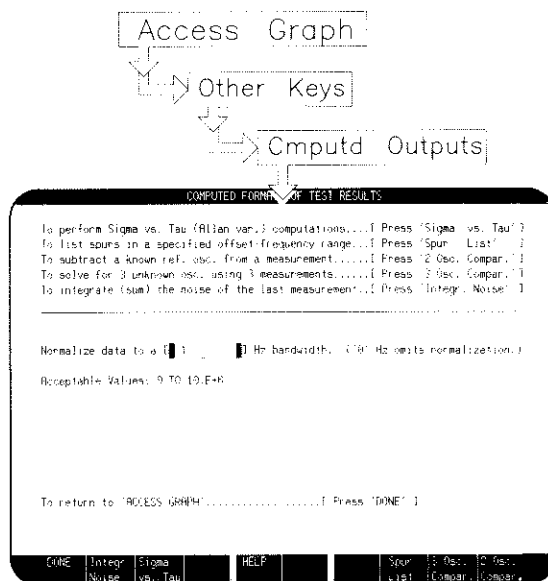

## Introduction

The Normalized Bandwidth function mathematically adjusts the measured noise data to a user specified bandwidth. The HP 3048A allows you to select bandwidths other than the default value of 1 Hz. Some applications, such as Doppler radar require that the results are plotted in other than a 1 Hz bandwidth (BW). The Normalized Bandwidth value can be changed before or after the measurement is made.



## Considerations When Changing the Normalized Bandwidth

Changing the BW effects the noise data but does not effect the spur level. The HP 3048A does not normalize marked spurs. However, unmarked spurs are treated as noise. Spurs are always marked at their actual level regardless of the normalization bandwidth. For example, changing the BW from 1 Hz to 10 Hz will raise the plotted noise data by 10 dB ( $10 \log 10 \text{ Hz}/1 \text{ Hz}$ ). The level of the marked spurs will not change.

The bandwidth value defined for the measurement is accessed in the Computed Output display. To re-plot the results in a new BW, enter the desired bandwidth, press **Done** then press the **Redraw Graph** softkey.

### What Effect Does Changing the Bandwidth Have on the Plotted Noise Level?

Increasing the normalization bandwidth causes the plotted noise level to increase by  $10 \log_{10} \text{ BW}$ . For example, changing the bandwidth from 1 Hz to 1 kHz will increase the plotted noise level 30 dB. ( $10 \log 1000 = 30 \text{ dB}$ ).

The default noise measurements are normalized to a 1 Hz BW. The units on the graph for a bandwidth of 1 Hz are dBc/Hz. For a 10 Hz BW normalization, the units are dBc/10 Hz.

## Normalization to 0 Hz Bandwidth

When you enter a Normalized Bandwidth of 0 Hz, the system plots the measured noise data without normalizing it. Plotting the measured data without normalization, causes all spurs, marked or unmarked to be plotted at their true level in dBc. The criteria for marking spurs is a function of the number of averages and the level of the spur. Spurs that were not marked in a 1 Hz Normalized Bandwidth can be observed at their actual level when there's no normalization of the noise.

When the measurement data is not normalized (0 Hz bandwidth), it is plotted in the actual bandwidth in which it was measured. As a result, breaks in the noise curve will appear at the band edges as shown in Figure 4-1.

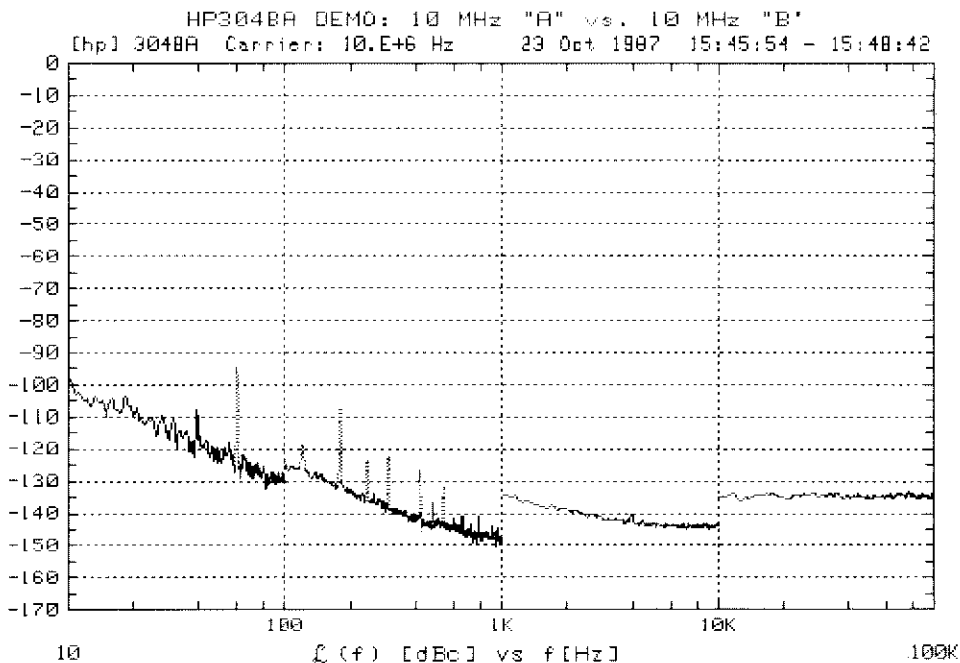
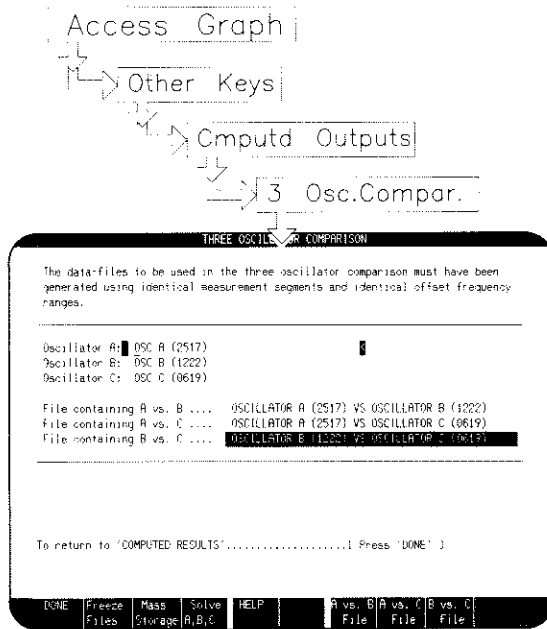

Figure 4-1. Noise Data Plotted in a 0 Hz Bandwidth.

## 3 Osc. Compar.



## Introduction

The 3 Oscillator Comparison function determines the phase noise level of each of three similar sources or devices. This function is useful when a reference source with a known lower noise level is not available for a direct comparison.

## Description

The 3 Oscillator Comparison function computes the noise level of three separate devices by measuring them in pairs (A vs. B, A vs. C, and then B vs. C). To achieve accurate results, each of the three measurements must be performed under the same conditions (frequency, measurement range, and segment definition). The system computes the noise level of each device by comparing and analyzing the measurement results for each of the three noise measurements. The system stores the computed noise level for each of the three devices in separate Result Files.

The following expressions are used to evaluate the three devices.

A vs. B = X	X = <i>The results of device A vs. B without spurs.</i>
A vs. C = Y	Y = <i>The results of device A vs. C without spurs.</i>
B vs. C = Z	Z = <i>The results of device B vs. C without spurs.</i>

Therefore:

A = (X + Y - Z)/2	A = <i>The result of device A only.</i>
B = (X + Z - Y)/2	B = <i>The result of device B only.</i>
C = (Y + Z - X)/2	C = <i>The result of device C only.</i>

## Measurement Uncertainty

To insure accurate results, the noise levels of the three devices should be within 3 to 6 dB of each other at the frequency offsets of interest. Computation uncertainty increases when the phase noise differs by more than 3 dB between the three devices. A minimum of 20 averages, defined in the Type/Range display, is recommended when making the noise measurements. A good test to use for verifying the validity of the noise measurements before performing the 3 Oscillator Comparison is to check that the combined level of the two lowest measurements is greater than or equal to the level of the highest measurement.

## How to Make a 3 Oscillator Comparison

1. **Measure** the phase noise level of the three devices, measuring them in pairs, and store the results in three separate files. (A vs. B, A vs. C, and B vs. C). (Refer to *Result Files* in Chapter 3, Graphic Functions if you need information about storing Result Files.)
2. Access the 3 Oscillator Comparison display from the main software level by pressing    .

---

### NOTE

The system expects to find the results for the 3 Oscillator Comparison stored in the defined mass storage.

---

3. Enter a title for each device in the **Oscillator A, B, and C** rows. (You are limited to 35 characters in the title.) We suggest using device related nomenclatures and serial numbers as a method for titling the devices.
4. Press the  softkey to select the Result File for the first pair of devices measured. You are required to select the proper files to be compared so that device (A) in (A vs. B) is the same as device (A) in (A vs. C) and so on.
5. Press  softkey to select the Result File for the second pair of devices measured.
6. Press  softkey to select the Result File for the third pair of devices measured.
7. Press the  softkey to return to the **Oscillator A** entry, and freeze the comparison files.
8. Press the  softkey to start the computation.
9. Once the computation is complete, the system stores the three results in the Result Directory. \*ONE OSC.\* is added to the titles entered for

- each result indicating that the data was computed, and only represents the noise level of one device.
10. To recall the results of each device, access the Results Directory by pressing **DONE** **Result Files**.
  11. To load a Result File, position the cursor at the appropriate title in the directory and press **Load File**.
  12. To display the noise graph on the current graticule, press **Done** **Other Keys** **Plot Data**.
  13. Pressing **Redraw Graph** will create a new graticule and only display the new data.

## Considerations for the 3 Oscillator Comparison Function

**Unmarked spurs** can cause erroneous results for the 3 Oscillator Comparison. Marked spurs are automatically stripped out during the computation, unmarked spurs are not. Unmarked spurs prevent the system from performing a proper subtraction since spurs cannot be subtracted on a power basis. Observe the measurement results to insure a minimum of unmarked spurs are present around the offsets of interest.

The number of unmarked spurs within the measurement can be reduced by either reducing the measurement bandwidth, or by increasing the number of averages specified. The number of averages are specified in the Type/Range display in the FFT and RF Segment Tables.

**“ERROR: Insufficient data file for 3 Oscillator Comparison”** message appears momentarily, if the system is unable to find three results to compare in the specified mass storage. Verify that the proper mass storage is specified for your Result Files. (Refer to *Result Files* in Chapter 3, Graphics Functions for detailed information on specifying a mass storage location.)

## 2 Osc. Compar.

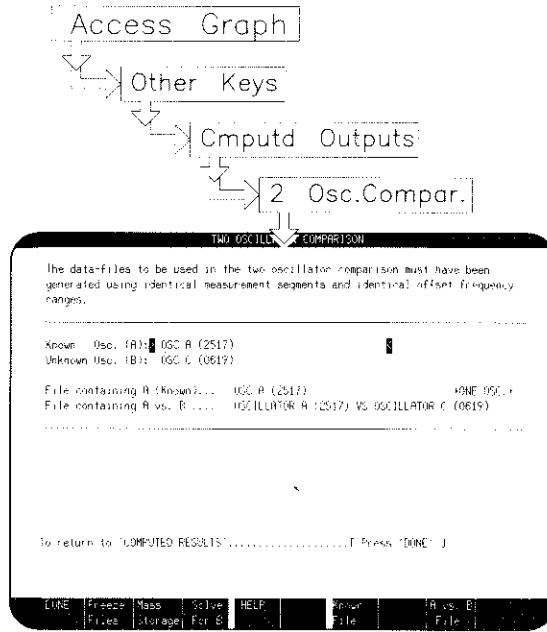

### Introduction

The 2 Oscillator Comparison function determines the actual phase noise level of the device under test (DUT) by subtracting the known noise level of the reference device. (This procedure is nearly identical to the 3 Oscillator Comparison function, except here only one measurement from a pair of devices is necessary.)

# Parameter Entry Descriptions

## Known Osc.

The 3 Oscillator Comparison function must be used to determine the noise level of the reference device (Known Osc.). Once a known reference level is established, the HP 3048A subtracts the reference noise from the measurement results. The 2 Oscillator Comparison function is only valid if the Measurement Definition parameters and the segment table parameters are kept the same for the reference device vs. the DUT, as when the reference device was measured using the 3 Oscillator Comparison function.

## Description

### Measurement Uncertainty

The noise level of the two devices should be within 3 to 6 dB of each other at the frequency offset of interest. The amount of uncertainty increases when the phase noise differs by more than 3 dB. Also, a minimum of 20 averages defined in the Type/Range display is recommended when measuring the devices.

## How to Make a 2 Oscillator Comparison

---

### NOTE

This procedure assumes that the 3 Oscillator Comparison function has been used to establish the noise level of the reference device (Known Osc.).

- 
1. **Measure** the known reference device against the DUT and **Store** the results at the same mass storage location as the Result File for the reference device. (Refer to *Result Files* in Chapter 3, Graphic Functions if you need information about storing files.)



2. Access the 2 Oscillator Comparison display from the main software level by pressing    .

---

### NOTE

The system expects to find the results for the 2 Oscillator Comparison stored in the defined mass storage.

---

3. Enter the title for each of the devices into the **Oscillator A and B** rows. (You are limited to 35 characters in the title.) We suggest using device related nomenclatures and serial numbers as a method for titling the devices.
4. Press the  softkey to select the result file for the devices measured. You are required to select the proper files to be compared so that device (A), in (A vs. B) is the known device and (B) is the unknown device.
5. Press the  softkey to return to the **Oscillator A** entry and freeze the comparison files.
6. Press the  softkey to start the computation.
7. Once the computation is complete, the system stores the results for the unknown device in the Result Directory. \*ONE OSC.\* is added to the file title to indicate that the data was computed, and only represents the noise level of one device.
8. To recall the results of the DUT, access the Results Directory by pressing  .
9. To load the Result File, position the cursor at the appropriate title in the directory and press .
10. To display the noise graph, press   .

## Considerations for Making a 2 Oscillator Comparison

**Unmarked spurs** can cause erroneous results for the 2 Oscillator Comparison. Marked spurs are automatically stripped out during the computation, unmarked spurs are not. Unmarked spurs prevent the system from performing a proper subtraction since spurs cannot be subtracted on a power basis. Observe the measurement results to insure that a minimum of unmarked spurs are present around the offsets of interest.

The number of unmarked spurs within the measurement can be reduced by reducing the measurement bandwidth, or by increasing the number of averages specified in the FFT or RF Segment Tables for the offsets of interest.

**“ERROR: Insufficient data files for 2 Osc Comparison”** message appears momentarily, if the system is unable to find three results to compare in the specified mass storage. Verify that the proper mass storage is specified for your Result Files. (Refer to *Result Files* in Chapter 3, Graphics Functions for detailed information on specifying a mass storage location.)

# Spur List

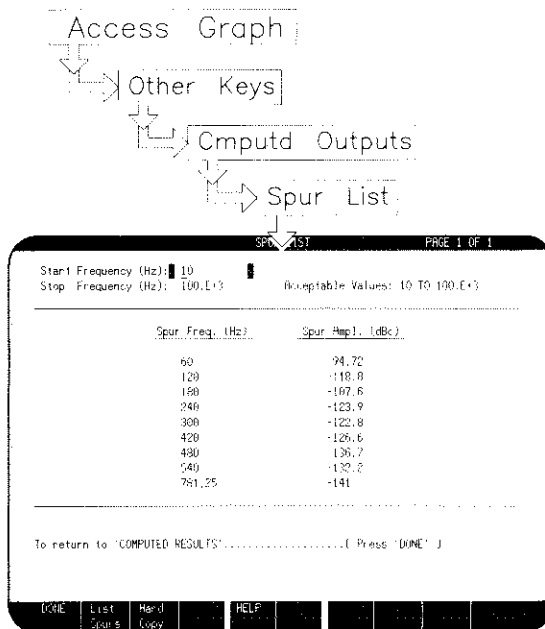

## Introduction

The Spur List function provides a listing of the frequency and amplitude of up to 100 spurs. The HP 3048A marks all detected spurs with a dotted line. The criteria for marking spurs is a function of the measurement BW and the amount the spur projects out of the noise. For offset frequencies less than or equal to 100 kHz, the amount the spur must project above the noise level to be marked as a spur is a function of the number of averages taken. All marked spurs are displayed at their true level. Only the marked spurs will be listed in the Spur List. Table 4-4 shows the amount spurs must project out of the noise to be marked.

**Table 4–4. HP 3048A Spur Marking Criteria**

<b>Offset Frequency</b>	<b>Number of Averages</b>	<b>Required Amount Spur Must Project Out of Noise to be Marked</b>
.01 Hz to 100 kHz	<4	30 dB
	4 to <8	17 dB
	8 to <30	12 dB
	≥30	6 dB
>100 kHz to 40 MHz	NA	4 dB

## **Considerations for the Spur List Function**

The Spur List function can list a maximum of 100 spurs from between the start and stop measurement range. If there are more than 100 spurs within this range, you may have to redefine the measurement to a subset of the initial measurement range.

The systems sensitivity for marking spurs can be determined by plotting the measurement results normalized to 0 Hz BW. This displays all spurs (marked and un-marked) at their true level.

## Phase Jitter in the Frequency Domain

Frequency domain jitter may be expressed in units of phase, frequency, fractional frequency, or time. Jitter is the total rms fluctuation of the particular quantity incurred when integrated over a specified frequency range.

The square root of the integral of spectral density of phase fluctuations,  $S_{\phi}(f)$ , over the (modulation rate range) is the phase jitter of that range.

### Frequency domain Phase Jitter in radians

Calculated by the HP 3048A Phase Noise Measurement System using the following equation.<sup>1</sup>

$$\Phi_{rms}[rad] = \left[ \int_{f_1}^{f_2} S_{\phi}(f) df \right]^{\frac{1}{2}}$$

### Frequency domain Phase Jitter in degrees

Calculated by the HP 3048A Phase Noise Measurement System using the following equation.<sup>1</sup>

$$\Phi_{rms}[deg] = \frac{360}{2\pi} \left[ \int_{f_1}^{f_2} S_{\phi}(f) df \right]^{\frac{1}{2}}$$

---

<sup>1</sup> Calculations are performed when you specify Sphi(f) as the Data Type in the Integrate Noise menu and enter the appropriate start and stop frequencies. The results are displayed in radians and degrees.

## Frequency domain Phase Jitter in Unit Intervals

Calculated by the User with the following equation.

$$\Phi_{rms}[UI] = \frac{1}{2\pi} \left[ \int_{f_1}^{f_2} S_{\phi}(f) df \right]^{\frac{1}{2}}$$

## Time Jitter in the Frequency Domain

Phase Jitter in the frequency domain can be expressed as a time jitter in the frequency domain.

Calculated by the User with the following equation.

$$t_{rms}[sec] = \frac{1}{2\pi\nu_0} \left[ \int_{f_1}^{f_2} S_{\phi}(f) df \right]^{\frac{1}{2}}$$

## Phase Jitter in the Time Domain

Time domain Jitter may be expressed in units of phase or time. Jitter is the total rms fluctuations of the particular quantity incurred during a specified time period of observation ( $\tau$ ).

The sigma of Allan Variance can be used to calculate jitter in the time domain over the specified time interval ( $\tau$ ) using the following equations:

### Time domain Phase Jitter in radians

Calculated by the User with the following equation.

$$\Delta\phi_{rms}[rad] = \sigma_y(\tau, f_h) 2\pi\nu_0\tau$$

### **Time domain Phase Jitter in degrees**

Calculated by the User with the following equation.

$$\Delta\phi_{rms}[deg] = \sigma_y(\tau, f_h)360^\circ\nu_0\tau$$

### **Time domain Phase Jitter in Unit Intervals**

Calculated by the User with the following equation.

$$\Delta\phi_{rms}[UI] = \sigma_y(\tau, f_h)\nu_0\tau$$

### **Time Jitter in the Time Domain**

Calculated by the User with the following equation.

$$\Delta\tau_{rms}[sec] = \sigma_y(\tau, f_h)\tau$$

---

#### **NOTE**

The time domain and frequency domain solutions for jitter in phase or time are not identical or equivalent, and similar results should not be expected.

---

## Scale Data

“Scale data to new carrier freq defined as:  $(f_c) * [1]$ ” (where  $f_c$  is the defined carrier frequency in the Instrument Parameters menu), allows you to plot results based on frequency changes in the carrier. This feature allows you to plot the noise of the measured source to a translated frequency. The carrier frequency is shown on the same line opposite the field for entering the scale factor. The scale factor is a direct multiple. Entering a factor-of-2 doubles the frequency, a factor-of-3 triples the frequency, and so on.

Plots made after the scale factor has been entered indicate noise for the scaled frequency. Noise levels increase for scale factors  $> 1$  and decrease for factors  $< 1$ .



## Shift Data

“Shift all data (including spurs) DOWN by ...[0] dB” allows you to move the noise plot up or down by entering a shift factor. Entering a positive number moves the plotted data down. Entering negative number raises the plot data. Use this function to compensate for known errors in the source being tested.

## Input Power at Amplifier

“Input power at amplifier for Noise Figure computation...[0] dBm” is used to create Noise Figure plots. Enter the input power level of the amplifier under test.



# Special Functions

---

# 5

## Introduction

The Special Functions allow the advanced user to manipulate the system or customize a measurement using the extended capabilities provided by the HP 3048A. These functions are recommended to be used only by those who understand how the function will affect the measurement and the system.

<b>Test Mode</b> .....	pg. 5-3
<b>Carrier Type</b> .....	pg. 5-9
<b>FFT Segments</b> .....	pg. 5-13
<b>RF Segments</b> .....	pg. 5-23
<b>Noise Monitor/New Noise Monitor</b> .....	pg. 5-29
<b>11848 Control</b> .....	pg. 5-35
<b>3048 System Checks</b> .....	pg. 5-43

## Test Mode

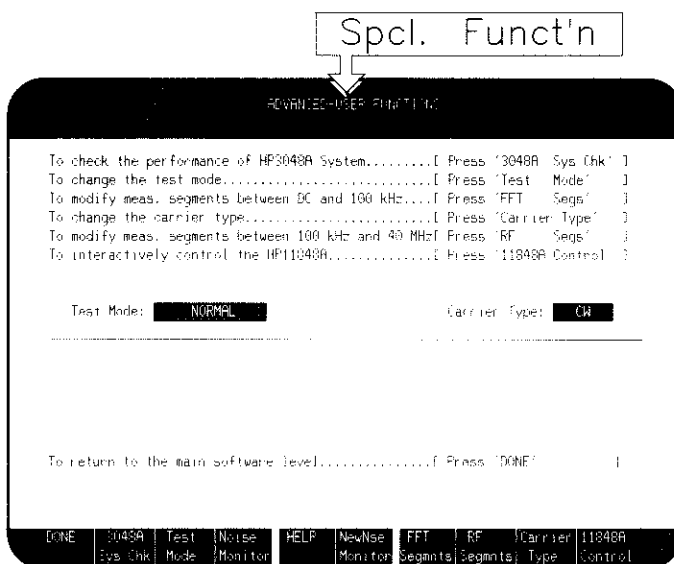

## Introduction

The TEST MODE softkey allows you to select between three operating modes for making measurements:

- Normal
- Trouble shoot
- Ignore Out Of Lock

## Description

### Normal Test

The Normal Test Mode is the default operating condition for the HP 3048A. The Normal Test Mode configures the system to perform each measurement in the minimum time and with the minimum amount of operator assistance.

### Trouble Shoot Mode

The Trouble Shoot Test Mode is helpful for trouble shooting the measurement. When the HP 3048A has been configured in the Trouble Shoot Mode, the 11848 Control softkey appears at various times throughout the measurement process, including in the Connect Diagram display. This softkey provides access to control of the HP 11848A's internal hardware.

---

#### NOTE

Changing the HP 11848A's internal hardware is considered an Advanced Function and should only be done by persons with a complete understanding of the HP 11848A's circuit block diagram and the measurement process. For further information on the HP 11848A control feature, refer to *11848A Control* in this chapter.

---

## Phase Lock Loop Suppression

Configuring the HP 3048A in the Trouble Shoot Mode also causes the system to display the plot of the PLL Suppression Curve when it is verified during the measurement calibration, whether an accuracy specification degradation occurs or not. Note that the PLL Suppression verification must be defined in the Calibration Process display prior to the measurement in order for verification to occur. (Refer to *Calibration Process* in Chapter 2, *Measurement Definitions* and *Parameter Summary* in Chapter 3, *Graphic Functions* for details about the PLL Suppression verification.)

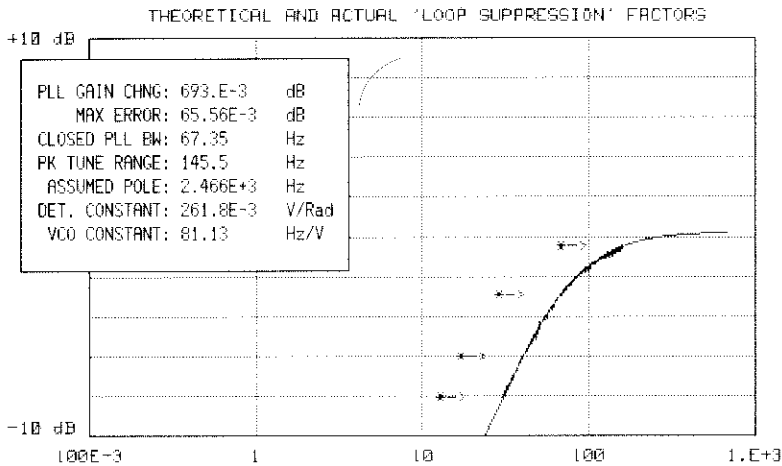

Figure 5-1. HP 3048A Display of the Phase Lock Loop Suppression Curve.

## PLL Suppression Parameters

The following measurement parameters are displayed along with the PLL Suppression Curve.

**PLL GAIN CHANGE:** This is the amount of gain change required to fit the Theoretical Loop Suppression curve to the measured loop suppression. A PLL GAIN CHANGE of greater than 1 dB will create an Accuracy Specification Degradation Error. If an Accuracy Specification Degradation is detected, the amount of error is determined from either the PLL GAIN CHANGE or the MAX ERROR, which ever is larger. The degradation itself is 1 dB less than the greater of these.

**MAX ERROR:** This is the measured error that still exists between the the measured Loop Suppression and the Adjusted Theoretical Loop Suppression. The four points on the Loop Suppression graph marked with arrows (ranging from the  $-3$  dB point down approximately  $-8$  dB) are the points over which the MAX ERROR is determined. An error of greater than 1 dB will result in an Accuracy Specification Degradation.

**CLOSED PLL BW:** This is the predicted Phase Lock Loop Bandwidth for the measurement. The predicted PLL BW is based on the predicted PTR. The Closed PLL BW will not be adjusted as a result of an Accuracy Specification Degradation. If an Accuracy Specification Degradation is detected, the amount of error is determined from either the PLL GAIN CHANGE or the MAX ERROR, which ever is larger. The degradation itself is 1 dB less than the greater of these.

**PK TUNE RANGE:** This is the Peak Tuning Range (PTR) for the measurement determined from the Tuning Constant and the Voltage Tune Range. This is the key parameter in determining the PLL properties, the Drift Tracking Range, and the ability to phase lock sources with high close in noise.



The PTR displayed should be approximately equal to the product of the VCO Tune Constant times the Voltage Tune Range. This will not be the case when a significant Accuracy Specification Degradation is detected ( $> 4$  dB) by the Loop Suppression Verification. In this case, the PTR and Assumed Pole are adjusted when fitting the Theoretical Loop Suppression to the smoothed measured Loop Suppression, and the system will not display the adjusted PTR. If the PTR must be adjusted by more than 1 dB, as indicated by an Accuracy Specification Degradation of greater than 0 dB, the Phase Detector Constant or the VCO Tuning Constant is in error at frequency offsets near the PLL BW, or the PLL BW is being affected by some other problem such as injection locking.

**ASSUMED POLE:** This is the frequency of the Assumed Pole required to adjust the Theoretical Loop suppression to match the smoothed measured Loop suppression. The Assumed Pole frequency will normally be much greater than the CLOSED PLL BW. An Assumed Pole frequency of less than  $10 \times$  PLL BW is an indication of peaking on the PLL Suppression curve. For PLL BWs less than 20 kHz, an Assumed Pole of less than  $10 \times$  PLL BW indicates a delay or phase shift in the VCO Tune Port. For PLL BWs greater than 20 kHz, the Assumed Pole may be adjusted to less than  $10 \times$  PLL BW to account for phase shifts in the HP 11848A.

**DET. CONSTANT:** This is the Phase Detector Constant (sensitivity of the phase detector) used for the measurement. The accuracy of the Phase Detector Constant is verified if the PLL suppression is verified. The accuracy of the Phase Detector Constant determines the accuracy of the noise measurement.

The Phase Detector Constant value, along with the LNA In/Out parameter, determines the HP 3048A System noise floor exclusive of the reference source.

**VCO CONSTANT:** This is the VCO Tuning Constant the system used for the measurement. The accuracy of the Tuning Constant determines the accuracy of the PLL noise measurement for offset frequencies greater than or equal to the phase lock loop bandwidth. The accuracy of the Tuning Constant is verified if the PLL Suppression is Verified. The Tuning Constant times the Voltage Tuning Range determines the Peak Tune Range (PTR) value for the measurement. The PTR sets the drift tracking and close-in noise suppression capabilities of the system.

## **Ignore Out Of Lock Mode**

The Ignore Out Of Lock Test Mode enables all of the troubleshoot mode functions, plus it causes the HP 3048A to not check for an out of lock condition before or during a measurement. This allows you to measure sources with high close-in noise that normally would cause an out of lock condition and stop the measurement. When Ignore Out Of Lock is selected, the user is responsible for monitoring phase lock. This can be accomplished using an oscilloscope by connecting it to the HP 11848A AUX. MONITOR port; verify the absence of a beatnote and monitor the dc output level.

## **Considerations for the Test Mode Function**

This Test Mode function, like all Special Functions, is considered an Advanced Feature. Use of these features can change the outcome of the measurement. It is sometimes left to the user to ensure measurement validity when changes have been made within the Special Functions. Remember:

- When Ignore Out Of Lock is selected, the system will not verify the phase lock of the measurement. The user must ensure that the measurement maintains phase lock during the measurement.
- Any changes entered into the 11848A Control screen can effect the measurement results or even the ability of the system to complete the measurement.

# Carrier Type

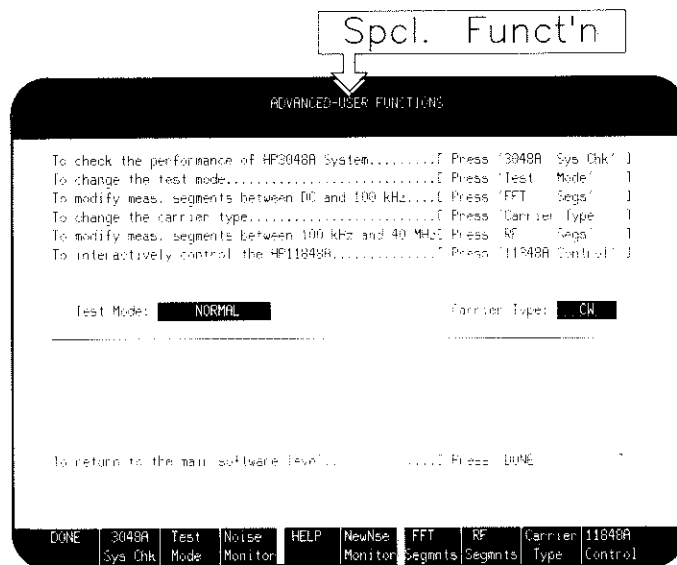

## Introduction

The Carrier Type function configures the HP 3048A for measuring a Continuous Wave (CW) carrier or a Pulsed (PULSED) carrier. The CW selection is the default Carrier Type. All measurements except pulse modulated measurements and some special cases should be made using the CW Carrier Type. The Pulsed Carrier Type is frequently useful in special cases for measurements on CW Carriers when the user wishes to control the Low Noise Amplifier (LNA) selection.

## Description

### Pulse Modulated Carriers

When a pulse modulated carrier is input to the phase detector, the PULSED Carrier Type usually should be selected. Selecting the PULSED Carrier Type configures the system to display the LNA Toggle softkey each time the decision to switch the Low Noise Amplifier in or out must be made. The user is responsible for choosing the correct state for the Low Noise Amplifier (LNA). To determine if the LNA should be in or out, connect an oscilloscope to the AUX. MONITOR port on the HP 11848A when the Connect Diagram appears. If the AUX. MONITOR port output level is less than 0.5 Vpk with the LNA In, leave the LNA switched in and proceed with the measurement. If the AUX. MONITOR port output is greater than 0.5 Vpk and there is significant clipping of the noise waveform with the LNA In, toggle LNA Out then proceed with the measurement. (In the case of pulsed measurements, clipping of narrow spikes at each edge of the pulse is acceptable (Refer to Figure 5-1).) Note that the HP 3048A's sensitivity (noise floor) is degraded by 20 dB when the LNA is out.

$$\text{LNA In} \leq 0.5 \text{ mV} > \text{LNA Out}$$

### Consideration for the Pulsed Carrier Function

When the PULSED Carrier function is selected and a phase noise measurement is being made, other than the phase lock loop type, the user is responsible for zero beating the sources and maintaining quadrature during the measurement. Zero beat is accomplished by manually adjusting the frequency of one of the sources so the beatnote frequency falls within the capture range for the system ( $< 10\%$  of PTR). For quadrature, monitor the dc level out of the HP 11848A AUX. MONITOR port with an oscilloscope. If the LNA is switched out, the dc level seen on the scope must be less than or equal to 20% of the Detector Constant value. If the LNA is switched in, quadrature must be maintained so that the LNA does not cause severe clipping.

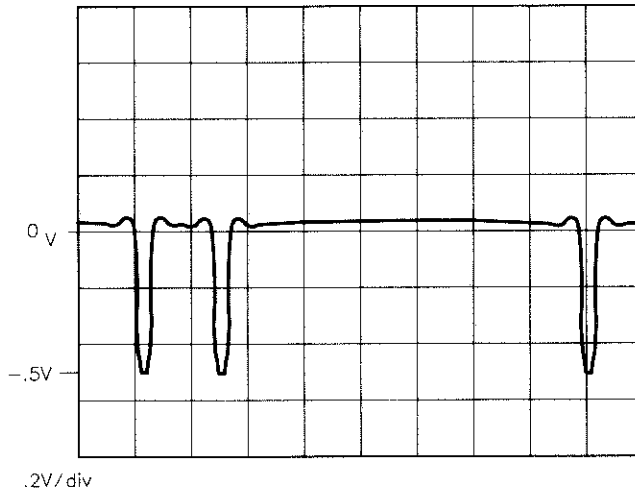

**Figure 5-2. Oscilloscope Display of Maximum Acceptable Clipping**

# FFT Segmnts



SWEET-SEGMENT DEFINITIONS FOR FFT ANALYZER

Plotted Range (Hz)		Measurement Range (Hz)		Min. Avg	BW (Hz)	Time Record Length (Seconds)
10E-3	1	0	1	1	.010	400.000
10	10	0	10	1	.095	40.000
100	100	0	100	5	.955	4.000
1000	500	100	500	30	3.819	1.000
5000	1.E+3	500	1.E+3	30	4.774	.800
1.E+3	10E+3	0	10E+3	100	95.485	.040
10E+3	100E+3	0	100E+3	100	954.850	.004

Acceptable Values: 1.E-3 TO 100.E+3

To return to 'ADVANCED-USER FUNCTIONS'.....[ Press 'DONE' ]

DONE
HELP
Delete Entry
Test Files

## Introduction

The FFT Segment function defines the measurement frequency spans (segments) for the HP 3561A Dynamic Signal Analyzer. The HP 3048A makes measurements by analyzing one segment of frequency data at a time. Up to 20 segments can be defined for each segment table. For frequencies up to 100 kHz, the FFT Segment Table is used. For frequencies from 100 kHz to 40 MHz, the RF Segment Table is used (refer to "RF Segmnts" in this chapter).

## Description

### The Default Table Values

The default FFT Segment Table provides an optimum set of values for most noise measurements. The default Segment Table values should be used the first time a new measurement is made. This guarantees that any measurement problems are not due to the defined segment table.

### Storing the Table

Segment Table data is stored whenever a Test File is created. When a Test File is loaded, the Segment Table data is set to the values stored in the Test File.

### Modifying the Table

Changes made to the Segment Table do not affect measurement accuracy, but changes can cause gaps in the Results Graph if the segments do not cover a continuous frequency range. Also, changes can result in longer than necessary measurement periods.

Any time the Segment Table is changed and  Repeat Msrmnt is selected the entire frequency offset range of interest should be remeasured, as existing segment data may be overwritten by new data.

### Considerations for Modifying the Segment Table

There is a basic trade-off between the resolution of a measurement and the time the measurement takes. To increase measurement resolution, frequency, or amplitude, you must be willing to accept longer measurement times. It may be possible, however, to minimize the increase in measurement time and still get the increased measurement resolution you need over a specific portion of the graph by decreasing the resolution for other portions of the graph.

## Ranges

The Measurement Range entries in the Segment Table define the measurement bandwidth of each segment. The Plotted Range entry defines what portion of the measured data will be plotted on the Results Graph. The Plotted Range can be the same as, or a subrange of the Measurement Range within the following limitation:

$$\text{Minimum Plotted Frequency} \geq \frac{\text{Measurement Range}}{100}$$

## Considerations for Changing Measurement Ranges

Due to the possible steepness of the slope of the phase noise curve slope, spurs are not marked for offset frequencies less than 10% of the Measurement Range.

$$f < \frac{\text{Measurement Range}}{10}$$

$f$  = frequency offset for which spurs are not marked

## Minimum Averaging

The Minimum Average value designates the minimum number of measurements the HP 3048A will make for a given Measurement Range. The values entered in the segment table may or may not be used depending on the minimum number of averages specified in the measurement definition. (Refer to *Type/Range* in Chapter 2, Measurement Definitions for further information about defining the minimum number of averages for the measurement.) The actual minimum number of averages used is the larger of the two averages specified.

For example, if the measurement definition specifies 4 as the minimum number of averages, and the Segment Table specifies 30 as the minimum number of averages for a given Measurement Range; the software will use 30 averages as the number of averages for that range.



## Considerations for Changing the Minimum Number of Averages

The default Minimum Average values have been selected so that the measurement time for each Measurement Range is approximately equal to the time it takes to process and plot the data taken during the previous measurement.

Increasing the number of averages reduces the scatter of the points around the true noise; however, it may also increase the time it takes to complete the measurement.

The following equations can be used to compute the measurement time using the greater of the two Minimum Average values.

**For HP 3561A Spans  $\leq 5$  kHz:**

$$\text{Measurement Time} = (1 + \text{Min. Avg}) \times \frac{\text{Time Record Length}}{2}$$

**For HP 3561A Spans  $> 5$  kHz:**

$$\text{Measurement Time} = \text{Min. Avg.} \times 60\text{msec}$$

## Bandwidth

The Bandwidth is automatically set by the HP 3048A to the appropriate value for each Measurement Range. The Bandwidth is determined by the Frequency Span setting of the HP 3561A. The Bandwidth value is approximately 1% of the HP 3561A's span setting. (Note that this is not the same as display resolution which is 0.25% of the span setting).

## Time Record Length

The Time Record Length is also determined by the HP 3561A Frequency Span and cannot be set independently. The Time Record Length is the approximate time it takes the analyzer to measure and record data for one measurement of the Measurement Range. Table 5-1 shows the relationship between span, record lengths, and display resolution for the HP 3561A.

**Table 5-1. Frequency Spans, Time Record Lengths, and Display Resolution for the HP 3561A**

Frequency Span (Hz)	Time Record Length (Sec.)	Display Resolution (Hz)	Frequency Span (Hz)	Time Record Length (Sec.)	Display Resolution (Hz)
100 000	0.004	250	32	12.5	0.08
50 000	0.008	125	25	16.0	0.0625
25 000	0.016	62.5	20	20.0	0.05
20 000	0.020	50	16	25.0	0.04
12 500	0.032	31.25	10.0	40.0	0.025
10 000	0.040	25	8	50.0	0.02
6 250	0.064	15.625	6.4	62.5	0.016
5 000	0.080	12.5	5	80.0	0.0125
4 000	0.100	10	4	100.0	0.01
3 125	0.128	7.8125	3.2	125.0	0.008
2 500	0.160	6.25	2.5*	160.0	0.00625
2 000	0.200	5	2	200.0	0.005
1 250	0.320	3.125	1.6	250.	0.004
1 000	0.400	2.5	1.28	312.5	0.0032
800	0.500	2	1*	400.	0.0025
625	0.640	1.5625	0.8	500.	0.0020
500	0.8	1.25	0.62	625.	0.0016
400	1.0	1	0.4*	1000.	0.001
250	1.6	0.625	0.32	1250.	0.0008
200	2.0	0.5	0.256	1562.5	0.00064
160	2.5	0.4	0.16	2500.	0.0004
125	3.2	0.3125	0.128*	3125.	0.00032
100	4.0	0.25	0.064*	6250.	0.00064
80	5.0	0.2	0.0512*	7812.5	0.000128
50	8.0	0.125	0.0256*	15625.	0.000064
40	10.0	0.1	0.01024*	39062.5	0.0000256

\* Zero start only

# How to Change the FFT Segment Table

## Example for Decreasing Measurement Time

The default FFT Segment Table can be modified to speed-up the measurement by performing the following procedure.

1. Delete the first two lines in the default table by placing the cursor on the first line and pressing the **Delete Segment** softkey twice.
2. Change the first entry under "Plotted Range" to 1.

The resulting table shown below provides measurements to 1 Hz minimum frequency offset in 2 minutes less time than the default settings for a four average measurement.

	Plotted Range (Hz)		Measurement Range (Hz)		Min. Av'g	BW (Hz)	Time Record Length (Seconds)	
1	-	100	0	-	100	5	.955	4.000
100	-	500	100	-	500	30	3.819	1.000
500	-	1E+3	500	-	1E+3	30	4.774	.800
1E+3	-	10E+3	0	-	10E+3	100	95.485	.040
10E+3	-	100E+3	0	-	100E+3	100	954.850	.004

---

### NOTE

A drawback when using this technique is the limit placed on marking spurs. For this example, spurs below 10 Hz will not be marked. The HP 3048A does not mark spurs within the first 10% of the measurement span.

---

## Decreasing Measurement Time for Measuring .1 Hz Offsets

The entries shown in the following table provide a decrease in measurement time for measuring down to .1 Hz minimum offsets. In this example, spurs < 1 Hz will not be marked.

Plotted Range (Hz)		Measurement Range (Hz)		Min. Av'g	BW (Hz)	Time Record Length (Seconds)
10E-3	- 1	0	- .1	1	.010	400.000
.1	- 10	0	- 10	1	.095	40.000
10	- 100	0	- 100	5	.955	4.000
100	- 500	100	- 500	30	3.819	1.000
500	- 1E+3	500	- 1E+3	30	4.774	.800
1E+3	- 10E+3	0	- 10E+3	100	95.485	.040
10E+3	- 100E+3	0	- 100E+3	100	954.850	.004

## Example for Measuring .001 Hz Offsets

The FFT Segment Table shown below demonstrates how the frequency offset range can be extended down to 0.001 Hz. These changes will increase the measurement time to approximately 5 hours for a measurement using 4 minimum averages.

Plotted Range (Hz)		Measurement Range (Hz)		Min. Av'g	BW (Hz)	Time Record Length (Seconds)
.001	- .064	0	- .064	1	.001	6250.000
.064	- 1	.064	- 1	1	.010	400.000
1	- 10	0	- 10	1	.095	40.000
10	- 100	0	- 100	5	.955	4.000
100	- 500	100	- 500	30	3.819	1.000
500	- 1E+3	500	- 1E+3	30	4.774	.800
1E+3	- 10E+3	0	- 10E+3	100	95.485	.040
10E+3	- 100E+3	0	- 100E+3	100	954.850	.004

## Example for Increasing Measurement Resolution

The FFT Segment Table shown below demonstrates how measurement resolution can be increased by dividing a Measurement Range into several parts. In this example, the default Measurement Range (0 to 10E+3 Hz) is divided into three ranges (1E+3 to 2E+3, 2E+3 to 3E+3, and 0 to 10E+3). This changes the bandwidth from 95.485 to 9.548 Hz over this range. Since the new bandwidth is less than 60 Hz, the 60 Hz spurs become visible on the plot. (The default Measurement Range will not resolve spurs spaced less than 96 Hz apart in this band.)

Plotted Range (Hz)		Measurement Range (Hz)		Min. Av'g	BW (Hz)	Time Record Length (Seconds)
10E-3	- 1	0	- 1	1	.010	400.000
1	- 10	0	- 10	1	.095	40.000
10	- 100	0	- 100	5	.955	4.000
100	- 500	100	- 500	30	3.819	1.000
500	- 1E+3	500	- 1E+3	30	4.774	.800
1E+3	- 2E+3	1E+3	- 2E+3	30	9.548	.400
2E+3	- 3E+3	2E+3	- 3E+3	30	9.548	.400
3E+3	- 10E+3	0	- 10E+3	100	95.485	.040
10E+3	- 100E+3	0	- 100E+3	100	954.850	.004

---

### NOTE

The consequence of the changes shown in this example is an increase in measurement time of approximately 30 seconds.

---

## Example for Increasing Measurement Resolution at Specific Frequencies

The FFT Segment Table shown below is configured to cause the HP 3048A to measure and plot the phase noise of a signal at specific offsets from the carrier frequency. This technique will generally give better resolution for each unique point analyzed, but the measurement may take longer due to the smaller bandwidth at each offset frequency. The segments can be either continuous, or separated into isolated segments.

Plotted Range (Hz)		Measurement Range (Hz)		Min. Av'g	BW (Hz)	Time Record Length (Seconds)
500E-3	- 1.5	500E-3	- 1.5	1	.010	400.000
5	- 15	5	- 15	1	.095	40.000
50	- 150	50	- 150	5	.955	4.000
500	- 1.5E+3	500	- 1.5E3	20	9.548	.400
5E+3	- 15E+3	5E+3	- 15E+3	100	95.485	.040
90E+3	- 100E+3	90E+3	- 100E+3	100	95.485	.040

---

### NOTE

The maximum number of Measurement Ranges that can be defined for the FFT Segment Table is 20.

The maximum offset frequency that can be specified in the FFT Table is 100 kHz.

---

# RF Segmnts

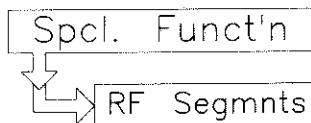

SWEEP-SEGMENT DEFINITIONS FOR RF ANALYZER

Plotted Range (Hz)	Measurement Range (Hz)	Min. Avg	BW (Hz)	Video BW (Hz)	Sweep Time
100E+3 - 500E+3	0 - 500E+3	1	3.E+3	10	20
500E+3 - 5.E+6	0 - 5.E+6	1	10.E+3	30	20
5.E+6 - 40E+6	0 - 40E+6	1	30.E+3	100	20

Acceptable Values: 1.E-3 TO 40.E+6

To return to 'ADVANCED-USER FUNCTIONS'.....[ Press 'DONE' ]

DONE HELP Delete Entry Test Files

## Introduction

The HP 3048A measurements are made by measuring one segment of frequency data at a time. Each segment is defined in a segment table. There are two segment tables; one table for the FFT analyzer (frequencies from .001 Hz to 100 kHz), and one table for an RF analyzer (frequencies from 100 kHz to 40 MHz). Up to 20 segments can be defined for each Segment Table.

# Description

## The Default Table Values

The default RF Segment Table provides an optimum set of values for most noise measurements from 100 kHz to 40 MHz. The default RF Segment Table values should be used the first time a new measurement is made. This guarantees that any measurement problems are not due to the RF Segment Table.

Plotted Range (Hz)		Measurement Range (Hz)		Min. Av'g	BW (Hz)	Video BW (Hz)	Sweep Time
100+3	- 500E+3	0	- 500E+3	1	3.E+3	10	20
500+3	- 5E+6	0	- 5E+6	1	10.E+3	30	20
5E+6	- 40E+6	0	- 40E+6	1	30.E+3	100	20

## Storing the Table

Segment table data is stored whenever a Test File is created. When a Test File is loaded, the RF Segment Table data is set to the values stored in the Test File.

## Modifying the Table

All fields in the RF Segment Table can be user defined, however, the values entered must reflect available settings for the particular RF analyzer you are using. The accuracy of the measurement results is dependent on the values defined in the RF Segment Table.

Changing the table can cause gaps in the Results Graph if the segments do not cover a continuous frequency range. Also, changes can result in a longer than necessary measurement time.

Any time the segment table is changed a New Measurement is recommended.



## Considerations for Modifying the Segment Table

There is a basic trade-off between the resolution of a measurement and the time the measurement takes. To increase measurement resolution, frequency, or amplitude, you must be willing to accept longer measurement times. It may be possible, however, to minimize the increase in measurement time and still get the increased measurement resolution you need over a specific portion of the graph by decreasing the resolution for other portions of the graph.

## Ranges

The Measurement Range entries in the RF Segment Table define the frequency range that the spectrum analyzer actually sweeps for each segment. The Plotted Range entry defines what portion of the measured data will be plotted on the Results Graph. The Plotted Range can be the same as, or a subrange of the Measurement Range within the following limitation:

$$\text{Minimum Plotted Frequency} \geq \frac{\text{Measurement Range}}{100}$$

## Considerations for Changing Measurement Ranges

Due to the possible steepness of the slope of the phase noise curve slope, spurs are not marked in the first 10% of the Measurement Range.

$$f < \frac{\text{Measurement Range}}{10}$$

$f$  = frequency offset for which spurs are not marked

## Bandwidth

The Bandwidth is automatically set by the HP 3048A to the appropriate value for each Measurement Range. The bandwidths defined in the RF Segment Table should not exceed those specified in the default RF Segment Table, but the bandwidths can be of finer resolution if desired. Bandwidths should typically be 1 kHz, 3 kHz, 10 kHz, 30 kHz, etc. These bandwidths are available on all supported RF analyzers. However, if your particular RF analyzer supports other bandwidths, they can be used. (Refer to your RF Spectrum Analyzer's Operating and Service manual for a list of the available bandwidths.)

---

### NOTE

A Bandwidth greater than 3 kHz should not be used in a segment including 100 kHz.

---

## Video Bandwidth

For accurate noise measurements, the video bandwidth entry should be defined using the following equation. Note that a smaller video bandwidth provides more smoothing of the noise but requires increased sweep time to maintain full accuracy on spurs.

$$\text{Video Bandwidth} = \frac{\text{Resolution Bandwidth}}{300}$$

## Sweep Time

The defined Sweep Time value for each segment affects the accuracy of the measurement results more than any other parameter in the RF Segment Table. The following procedure can be used to decrease the Sweep Time below the spectrum analyzer's normal setting for the specified frequency span, resolution bandwidth, and video bandwidth and maintain measurement accuracy.

1. Connect a signal to the RF analyzer input. The frequency of the input signal must be within the Measurement Range of the segment of interest. A higher frequency signal can be used provided the span is maintained and centered on the signal.
2. Set the RF analyzer to the Measurement Range (span), Bandwidth, and Video Bandwidth specified for the segment. (The RF analyzer will select an appropriate default Sweep Time setting.)
3. Position the marker to the peak of the input signal and note the level of the signal.
4. Begin decreasing the Sweep Time and note the change in the signal level for each change from the level in Step 3. To maintain adequate measurement accuracy, the signal level should not change by more than .3 dB. Enter the resulting value in the Segment Table. Typically, the sweep time can be reduced by a factor of 2 or more from the value set by the analyzer.

---

### NOTE

The HP 3048A makes accurate measurements even though the RF analyzer may be indicating that it is being operated in an uncalibrated condition, as long as the above procedure has been used to verify the response.

---

## Noise Monitor / NewNse Monitor

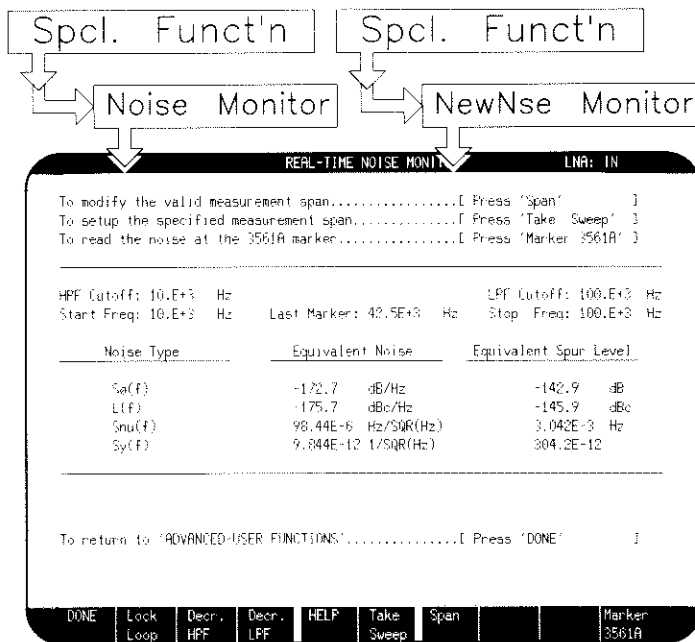

## Introduction

The Noise Monitor function allows you to perform single point and real time evaluations of the measured noise. This function allows you to select specific spans and filters for the analyzers and HP 11848A Interface to more closely evaluate the noise spectrum. Using the analyzer's marker function, the HP 3048A reads the frequency and amplitude of a single point and returns the value normalized to a 1 Hz Bandwidth for  $L(f)$ ,  $S_{\phi}(f)$ ,  $S_{\mu}(f)$ , and  $S_y(f)$ , and an unnormalized spur value for each output type.

## Noise Monitor vs. New Noise Monitor

Noise Monitor and New Noise Monitor are the same function except that when the **New Noise Monitor** softkey is selected, a measurement calibration is completed before the noise data is displayed. When the **Noise Monitor** softkey is selected, the HP 3048A assumes that a measurement has already been made during which the measurement calibration constants were created. Noise Monitor is typically selected after a measurement has just been completed and you wish to investigate a particular portion of the results.

## Softkey Descriptions

**Lock Loop:** Performs all of the system checks that ensure phase lock of the sources. (SHIFT Lock Loop: Toggles the Out of Lock indicator in the HP 11848A Phase Noise Interface.)

**Decr. HPF:** Decreases the High Pass Filter within the HP 11848A Phase Noise Interface. These HPFs are in decade steps and are designed to permit increased sensitivity of the HP 3561A Dynamic Signal Analyzer by filtering out undesired segments of the broadband noise. The **HPF Cutoff:** window indicates the specified value of the filter selected. (SHIFT Decr. HPF: Increases the HPFs.)

**Decr. LPF:** Decreases the Low Pass Filter within the HP 11848A Phase Noise Interface. These LPFs are in decade steps and are designed to permit increased sensitivity of the HP 3561A Dynamic Signal Analyzer by filtering out undesired segments of the broadband noise. The **LPF Cutoff:** window indicates the specified value of the filter selected. (SHIFT Decr. LPF: Increases the LPFs.)

**Take Sweep:** Performs a sweep of the displayed frequency span as defined in the Segment Table, from the Start Freq. to the Stop Freq. Take Sweep will use the frequency spans specified in the FFT and RF Segment Tables to measure the Sweep span specified. (The number of sweeps taken for each measurement is determined by the number of averages defined in the Type/Range display and in the segment table.)

**Span:** Steps through the frequency spans defined in the FFT and RF Segment Tables. Span also specifies the frequency span that will be measured. (SHIFT Span: Steps back through the segments.)

**Marker 3561A:** Displays the corrected amplitude and frequency of the point indicated by the marker on the HP 3561A Dynamic Signal Analyzer. For valid data to be displayed, the HP 3561A's span setting must be exactly the same as defined in the FFT Segment Table.

**Marker (RF\_Analyzer):** Displays the corrected amplitude and frequency of the point indicated by the marker on the RF Analyzer configured in the System Configuration Table. For valid data to be displayed, the RF analyzer's span and resolution bandwidth settings must be exactly the same as defined in the RF Segment Table.

**11848A Control:** This function allows control of the programmable circuits in the HP 11848A Phase Noise Interface using the computer and HP-IB. Each feature of this function is discussed in detail in the HP 11848A Control information in this section of the manual.

(This function is only available in the Noise Monitor menu if the Test Mode has been set to Trouble Shoot.)

# How to Use Noise Monitor

## Evaluating a Single Offset Frequency

1. Press the **SPAN** softkey to increment the frequency span. The increment values are the measurement ranges defined in the segment tables.
2. Press **Take Sweep**. Take Sweep sets up the Interface, autoranges the analyzer, measures the span, and holds the averaged display.

---

### NOTE

Noise Monitor allows the user to manipulate the Front Panel controls of the analyzer. After the Interface is set up, the analyzer settings can be changed.

(Note that changing the bandwidth to other than the one set up by the Take Sweep softkey will cause the Marker function to return inaccurate data.)

---

3. Place the analyzer's marker at the desired frequency.
4. Select the appropriate **Marker** softkey to read and display the value of the marker.

## Evaluating Phase Fluctuations as a Function of Time

Real Time Noise measurements can be useful for evaluating noise transients or device sensitivity to mechanical or electrical stimulation. Continuous Real Time display of the noise measurement can be made by turning the averaging function on the analyzer off (or by setting the analyzer for repeat display or continuous sweep.)

---

## NOTE

The user is responsible for setting the Front Panel controls on the analyzer for Real Time Measurements. The HP 3048A Noise Monitor function will return calibrated values for the points of interest as long as the bandwidth has not been changed from the bandwidth set up by the Take Sweep function as specified in the RF or FFT Segment Table.

---

1. Press the **Span** softkey to set the Start Freq. and Stop Freq. as defined in the Segment Table.
2. Press the **Take Sweep** softkey to set up the HP 11848A analyzer, and to take a measurement exactly as specified in the segment table.
3. After the analyzer starts taking data, it is placed in local and its settings may be modified:

### For a Continuous Display

Press **AVG** and **OFF** on the HP 3561A.

### For a Repeat, Averaged Display

Press **AVG** **RMS** **DEFINE NUM AVGS** (key in number of averages) **ENTER** **SELECT SETUP** **REPEAT DISPLAY**. This sets up the HP 3561A for a continuous display covering the entered number of averages. RF analyzers can also be set up for continuous display using a similar process.



---

## NOTE

The MARKER "ANALYZER" function should only be used within the offset frequency ranges defined in the Plot Ranges in the RF Segment Table. To acquire calibrated data at frequencies outside the range of the current span, it is necessary to change the Start Freq. and Stop Freq. and do another Take Sweep.

---

### To Display the Noise in the Time Domain on the HP 3561A

1. Press **Span** to select the desired Start and Stop frequencies.
2. Press **Take Sweep** to set up the measurement to include the frequency of interest.
3. On the HP 3561A press **AVG** **OFF** **NEXT TRACE** **FORMAT** **SINGLE**. This displays the time record on the HP 3561A display.

# 11848A Control

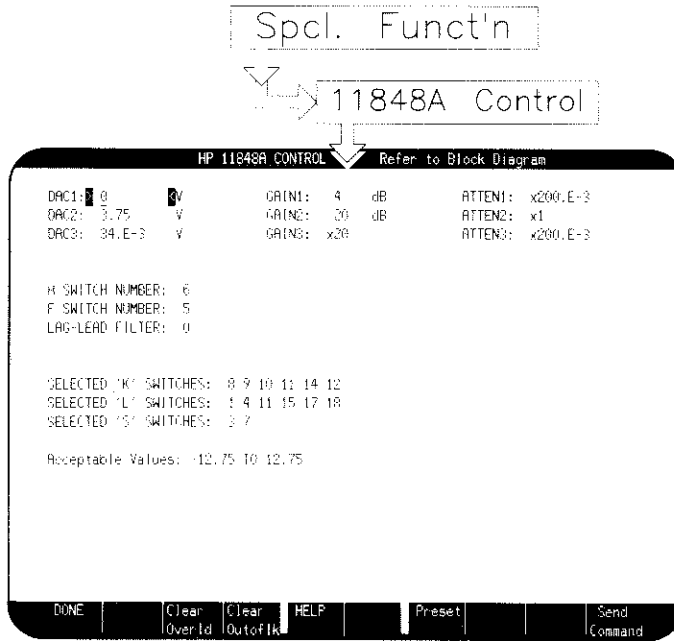

## Introduction

The 11848A Control function gives the user direct and arbitrary control of the programmable circuits in the HP 11848A Phase Noise Interface via the computer and HP-IB.

## Description

---

### NOTE

If HP 11848A settings are changed by the user, it is possible for the Measurement Results to not be valid until a New Measurement is performed.

Also, it may be possible to damage external equipment connected to the HP 11848A as a result of changing the settings within it.

---

The 11848A Control function is useful for setting up special measurement conditions to assist in diagnosing a suspected Interface problem, and to give the user a snapshot of the signal path configuration. It is also used during System calibration. (Refer to the *HP 3048A Calibration Manual* for the System Calibration procedures.)

The operation of this function is coupled to the Block Diagram of the HP 11848A. The Block Diagram with accompanying Notes is presented on a foldout in the back of this section. (The theory of operation for the Block Diagram of the HP 11848A, as well as a description of the HP 11848A's role in making a phase noise measurement, can be found in the *HP 11848A Service Manual*.)

**Table 5-3. List of Circuit Controls for the HP 11848A (1 of 2)**

Control	Description	Acceptable Values
DAC1	Digital to analog converter summed into the summing amplifier for PLL Tune Voltage and Center Voltage.	-12.75 to 12.75V in 50 mV steps.
DAC2	Digital to analog converter that controls <i>coarse</i> Frequency Set voltage for the HP 11848A internal VCOs.	0 to 12.75V in 50 mV steps.
DAC3	Digital to analog converter that controls <i>fine</i> Frequency Set voltage for the HP 11848A internal VCOs.	0 to 255 mV in 1 mV steps.
GAIN1	First programmable amplifier in the PLL circuit path of the HP 11848A.	0 to 28 dB in 4 dB steps.
GAIN2	Second programmable amplifier in the PLL circuit path of the HP 11848A.	6 to 20 dB in 2 dB steps.
GAIN3	Programmable amplifier in the $\leq 100$ kHz path prior to the selectable Low Pass Filters.	$\times (2,4,10,20)^*$
ATTEN1	Programmable attenuator at the output of the HP 11848A rear-panel Tune Voltage Output port.	$\times (1,0.5,0.2,0.1)^*$
ATTEN2	Programmable attenuator within the PLL circuit path of the HP 11848A prior to the Summing Junction.	$\times (1,0.5)^*$
ATTEN3	Programmable attenuator at the output of the HP 11848A front-panel Tune Voltage Output port.	$\times (1,0.5,0.2,0.1)^*$
* These values are the multipliers for the available gain and attenuation settings.		

**Table 5-3. List of Circuit Controls for the HP 11848A (2 of 2)**

<b>Control</b>	<b>Description</b>	<b>Acceptable Values</b>
H SWITCH NUMBER:	Programmable rotary switch that switches in the High Pass Filter paths.	0 through 7
F SWITCH NUMBER:	Programmable rotary switch that switches the Low Pass Filter paths.	0 through 6
LAG-LEAD FILTER:	Programmable filter that selects the poles and zeros of the PLL circuit path.	0 through 7
SELECTED 'K' SWITCHES:	Programmable switches represented by a K and shown in Preset state on the Block Diagram. Entry of a switch number causes that switch to toggle to the opposite state from that shown in Block Diagram.	N/A
SELECTED 'L' SWITCHES:	Programmable switches represented by an L and shown in Preset state on the Block Diagram. Entry of a switch number causes that switch to toggle to the opposite state from that shown in Block Diagram.	N/A
SELECTED 'S' SWITCHES:	Programmable switches represented by a S on the Block Diagram. Entry of a switch number causes that switch to toggle to the opposite state from that shown in Block Diagram.	N/A

# Considerations When Using the 11848A Control

## Moving the Cursor

Use the TAB key to move the cursor horizontally left to right. (SHIFT TAB moves the cursor right to left.) Use the up and down arrow keys to move the cursor vertically. The right/left arrow key as well as the keyboard knob will also control the cursor.

## Entering Field Values

Value entries are made by positioning the cursor to the appropriate field and then keying in the desired value. Press the Send Command softkey to initiate the change within the HP 11848A.

## Manipulating Rotary Switches

The H and F switches are rotary switches. (These switches are located at the bottom center of the Block Diagram). Only one position can be selected at a time for each switch. To move the rotor to a position, key in the desired position and press the Send Command softkey.

## Manipulating Non-Rotary Switches

To change the position of a selected switch, enter the number of the desired switch and press the Send Command softkey. This causes the switch to toggle to the opposite position from that shown in the Block Diagram.

## K Switches

Switches K8 and K9 switch together, and switches K11 and K14 switch together. Thus, if "8" is keyed into the K switch field, "8" and "9" will both appear in the field after sending the command and both switches will be placed in the state opposite to that shown in the Block Diagram (that is, the Low-Noise Amplifier will be switched in). Furthermore, to remove switch 8 from the field, both "8" and "9" must be removed.

## L Switches

The L switches control a variety of functions. At preset, all L switches (except L3, which is a rotary switch) are set to the "0" state. Entering an L switch number and pressing the  softkey causes that L switch to change to its "1" state. For example, the A7 10 MHz Modulated VCXO B Assembly, located at the right center of the Block Diagram is controlled by L15. (Note the parenthetical comment near the oscillator symbol "L15 = 1, OSC ON".) When the HP 11848A is preset, L15 = 0 and the oscillator is off. If "15" is entered into the L switch field and the command is sent, the state of L15 will be set to "1"; "15" will remain in the displayed L switch field, and the oscillator will be turned on.

## Sending Commands

Press the  softkey to initiate a change within the HP 11848A. Several changes can be set up and then the command sent to change them all at the same time. Unacceptable value entries are indicated as soon as the cursor changes fields, or when the Send Command is initiated.

## The Clear Functions

The Clear Overld and Clear Outoflk softkeys clear the Overload and Out-of-Lock Flip-Flops as indicated by the respective front-panel annunciators (assuming, of course, that the overloading or lock-breaking condition has been removed).

# Block Diagram Notes

- Switches on the Block Diagram are shown in their HP-IB preset state. At Interface turn-on with no controller connected, the power-up state is the same as the HP-IB preset state except:
  - ATTEN 1 is set to an open-circuit (non-programmable) state, and
  - the switches of cluster S5 through S8 are all open.

- The transfer function of GAIN 2 also has a lead-lag response as follows:

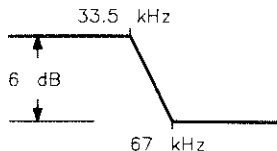

- The transfer function of Lag-Lead Network 1 is as follows:

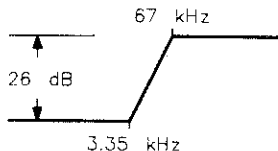

To this transfer function is added a programmable lag-lead with the following poles and zeros:

Lag-Lead Number	Pole Frequency	Zero Frequency	Attenuation
0	4.82 Hz	9.95 Hz	6 dB
1	8.01 Hz	40.1 Hz	14 dB
2	9.17 Hz	115.9 Hz	22 dB
3	9.68 Hz	306 Hz	30 dB
4	9.95 Hz	784 Hz	38 dB
5	9.95 Hz	1.985 kHz	46 dB
6	9.95 Hz	5.00 kHz	54 dB
7	9.95 Hz	12.58 kHz	62 dB

- Assemblies A6, A8, and A9 are controlled as follows:

Control Line	State		
	A6	A8	A9
L17	Off	On	On
L18	Off	On	Off
L17, L18	On	Off	Off

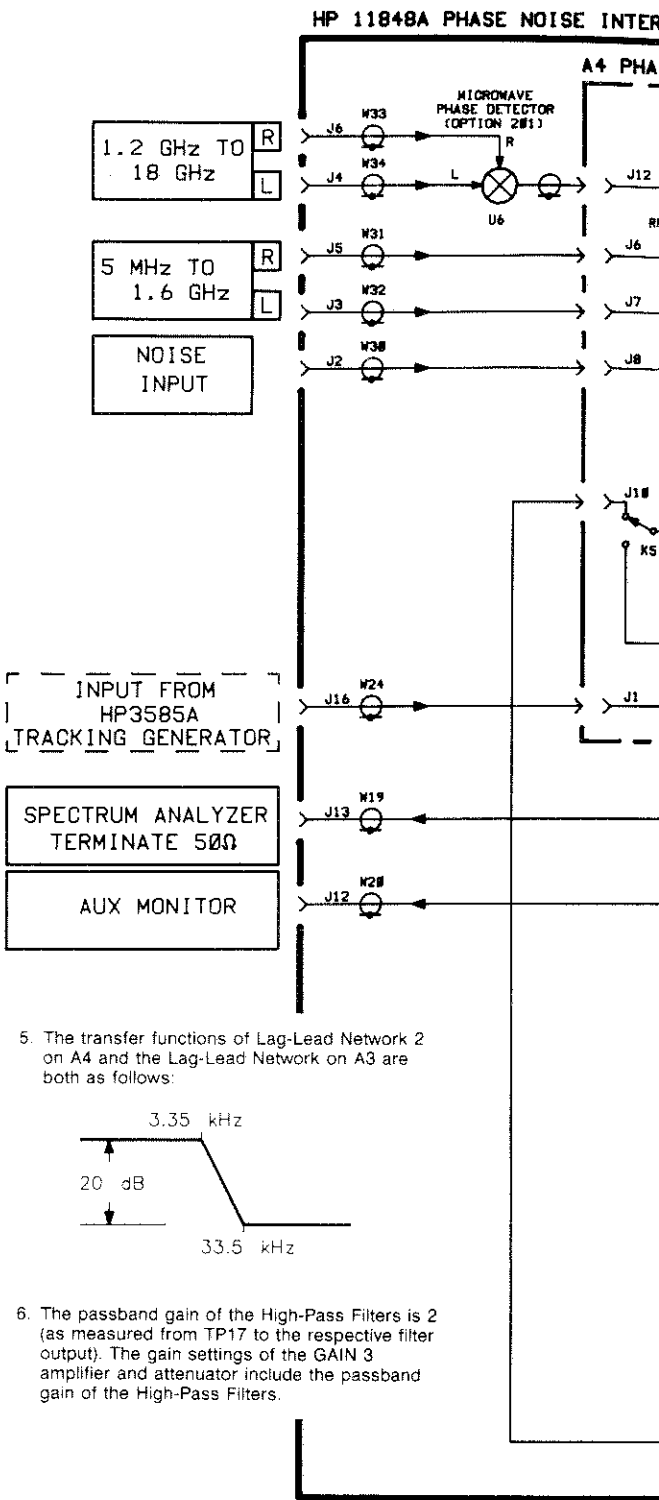



SEMBLY

A2 LED ASSEMBLY

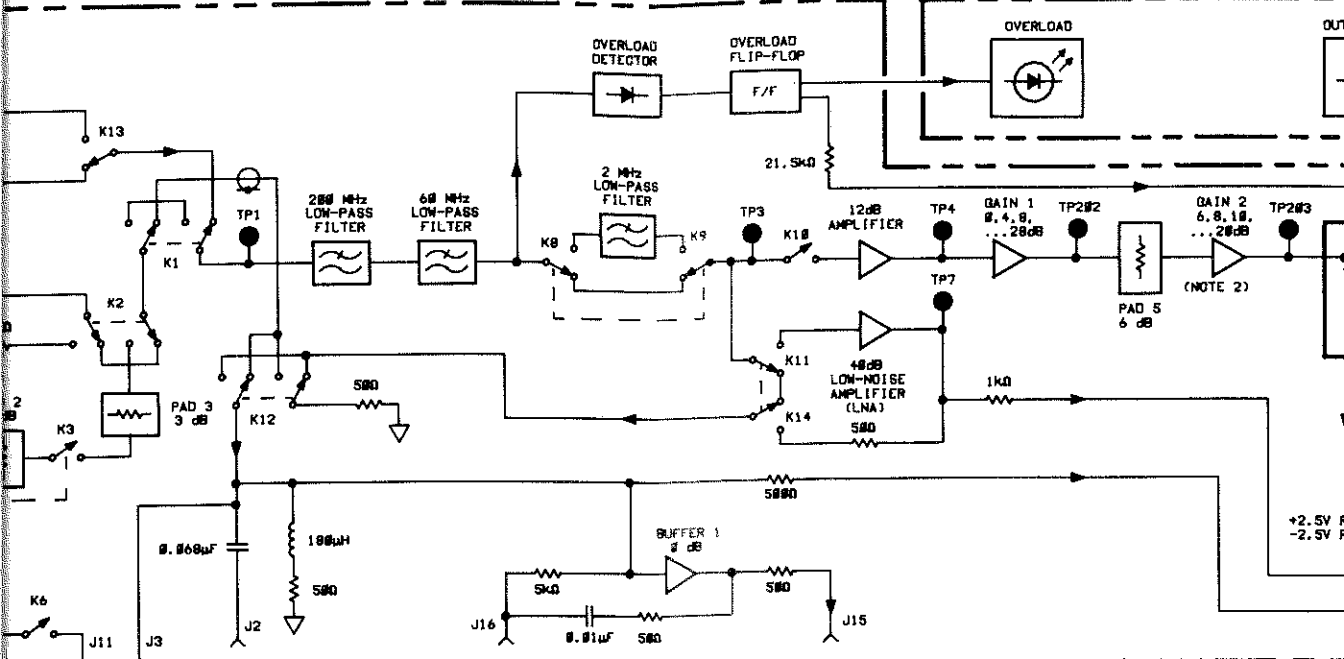

A3 ANALYZER INTERFACE

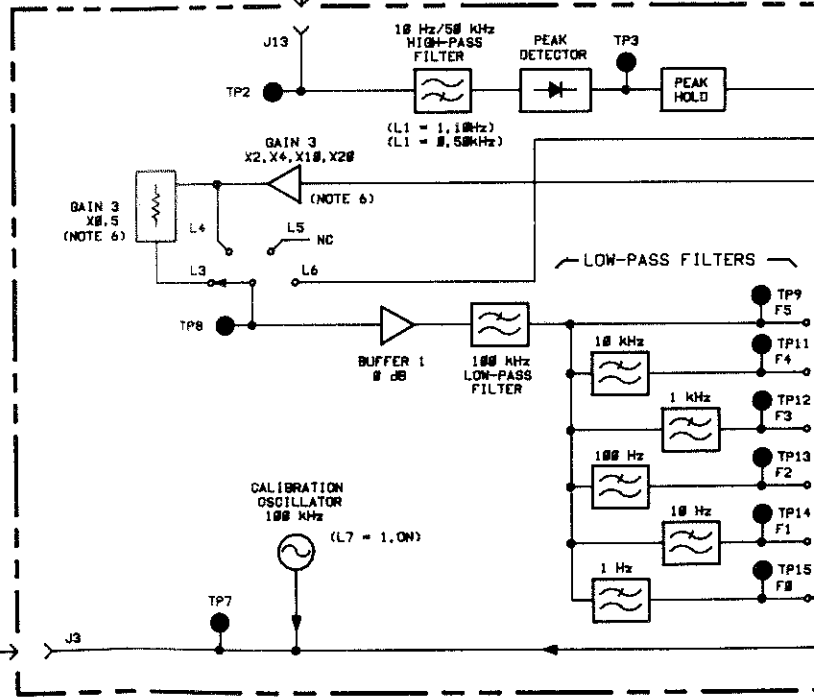

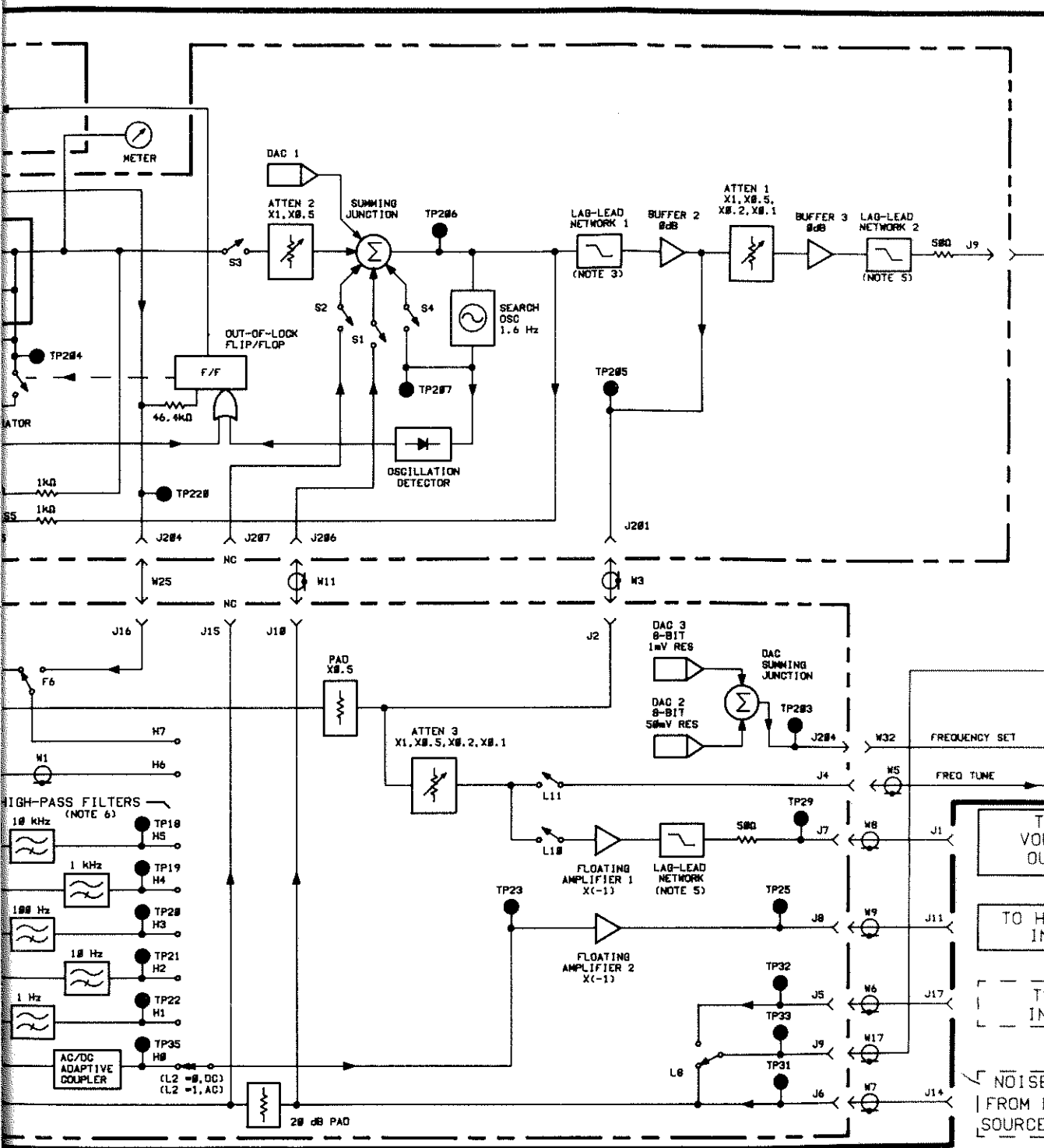

TO NOISE FROM SOURCE

### A9 400 MHz OSCILLATOR ASSEMBLY

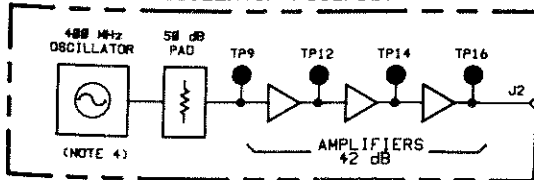

400 MHz  
-5 dBm

TUNE VOLTAGE  
OUTPUT

### 350-500 MHz VCO ASSEMBLY

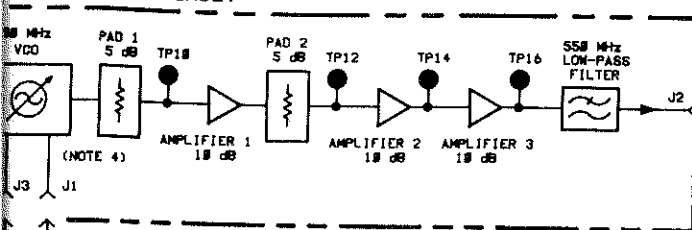

350-500 MHz  
+17 dBm

### A7 10 MHz MODULATED VCXO B ASSEMBLY

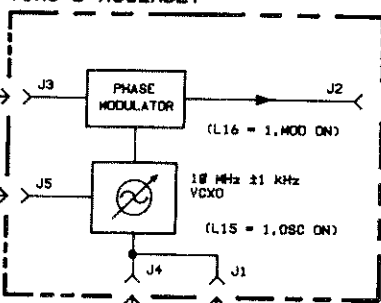

10 MHz B  
+6 dBm

### A6 10 MHz VCXO A ASSEMBLY

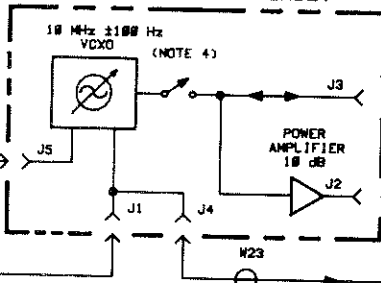

10 MHz  
[SOURCE A OUTPUT]  
OR AMP INPUT  
+7 dBm

10 MHz A  
+15 dBm

## Block Diagram

# 3048A Sys Chk

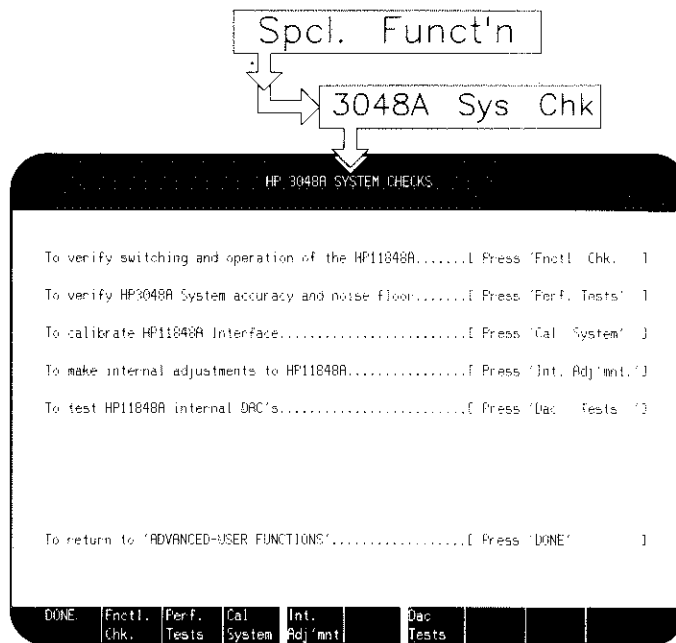

## Introduction

The 3048A System Checks function accesses the calibration and performance verification capabilities for the HP 11848A Interface, and HP 3048A Phase Noise System. (The HP 3048A System Checks are described completely in the *HP 3048A Calibration Manual*.)

## Softkey Descriptions

The following functions are available from the HP 3048 System Checks display.

**Int. Adj'mt:** Accesses the adjustment procedures for the HP 11848A's internal circuitry.

**Functl. Chk.:** Accesses the functional checks for verifying operation (including switching) of the HP 11848A.

**Dac Tests:** Accesses the DAC tests for checking each bit of the digital-to-analog converters within the HP 11848A.

**Cal System:** Accesses the calibration routines for the PLL path and the measurement paths of the HP 11848A.

**Perf. Tests:** Accesses the Performance Tests for verifying the spur accuracy to 550 kHz (Spur Test) for verifying the system's absolute noise floor (Noise Floor), and for generating the CALDATAHI corrections from 500 kHz to 40 MHz (Noise Flatness).

---

### NOTE

When the system loads a Performance Test Test File from the System Data Disc, the Segment Tables, as well as all of the Measurement Definitions, are loaded into memory. The Segment Table for each Performance Test has been optimized for the measurement.

After performing a Performance Test, you should always verify that the Segment Table entries are suitable for your measurements before initiating a New Measurement.

---

## Description

### The Calibration Routines

The Cal System softkey accesses the calibration routines for the Phase Lock Loop path and the HP 11848A.

These calibration routines generate CALDATALO and CALDATAHI for the system, and the nominal voltages (VNOMS) for setting the HP 11848A's internal sources. The following is a list of the calibration capabilities provided for the system:

- Calibration of the HP 11848A Phase Noise Interface measurement paths (Cal to 100 kHz and Cal to 40 MHz).
- Calibration of the center frequencies of the HP 11848A Internal Sources (VNOMS).
- Evaluation of the Calibration Data currently in memory (Eval. Caldata). This function accesses a display that allows selection of specific paths within the HP 11848A Interface. (Operation of this display is the same as for 11848A Control described in this chapter). The Eval. Caldata function allows you to evaluate the corrections for each measurement path independently, or together. This routine does not actually change the HP 11848A switch positions, it only simulates changes using the measured caldata.
- Management of the Calibration Data (Manage Caldata). This function provides for STORING, LOADING, and CLEARING the calibration data (CALDATALO, CALDATAHI, and VNOMS) for the mass media defined in the System Configuration Table.

# How to Manage Calibration Data

## Loading Calibration Data

The Load Caldata softkey initiates the routine to load caldata from the mass media. If the System's mass media is a hard disc or SRM and the HP 11848A has been returned from repair or annual calibration with a System Data disc containing the new Calibration Data, you will need to load the new calibration data onto the mass media. The following steps describe the loading process.

1. Change the location of the "Calibration Data" within the Mass Storage display to a connected disc drive.
2. Insert the disc containing the new calibration data into the disc drive.
3. Access the Manage Caldata routine (from the Main Software Level) by pressing the following softkeys:

4. Press  to load the caldata into memory.
5. Change the location of the "Calibration Data" entry within the Mass Storage display back to the hard disc or SRM.
6. Access the Manage Caldata routine again (from the Main Software Level) by selecting the following softkeys:

7. Press  to store the caldata to a hard disc or SRM.

## Clearing Caldata

The Clear Caldata softkey sets the caldata corrections to zero. This is sometimes helpful for evaluating the effect of the calibration on the measurement paths.

# System Conf

SYSTEM CONFIGURATION

NAME	MODEL #	ADDR	SERIAL #	OPTION #
COUNTER	5384A	709		
DOWN CONVERTER	11729C	706		130
FFT ANALYZER	3561A	712	2549A03335	
INTERFACE	11846A	720	2649A00132	391
PLOTTER	7475A	705		
PRINTER	THK JET	701	2634S30486	
RF ANALYZER	3585A	711		
RF SOURCE1	3662A	719		001
VOL METER	3475A	708		

\* Instr. Not Responding

To return to the main software level..... Press 'DONE' )

DONE	System	Delete	Plotter	HELP	Mass	Store	11729C	Load	Load
	Clock	Instr.	Parms		Storage	Config	Specs	Alt.	Config





# System Configuration

# 6

## Introduction

The System Configuration menu allows you to set up a table of supported equipment that you want to have under HP-IB control. It verifies which instruments are configured on the bus and whether or not they are responding. System Configuration also allows you to set the system clock, load/store the configuration table, set the mass storage ID, choose plotter pens, and set 11729C filters. The HELP text for System Configuration lists such things as valid instrument names and supported model numbers.

<b>Supported Equipment Table</b> .....	pg. 6-2
<b>RF Sources (with phase noise performance graphs)</b> .....	pg. 6-3
<b>RF Analyzers</b> .....	pg. 6-23
<b>Down Converters</b> .....	pg. 6-31
<b>Frequency Counters</b> .....	pg. 6-45
<b>Digital Voltmeters</b> .....	pg. 6-47
<b>Controllers</b> .....	pg. 6-49
<b>Mass Storages Devices</b> .....	pg. 6-51
<b>Plotter</b> .....	pg. 6-55
<b>System Clock</b> .....	pg. 6-59
<b>Load Alternate Program</b> .....	pg. 6-61
<b>Additional Equipment</b> .....	pg. 6-63
<b>Printers</b> .....	pg. 6-65

The HP 3048A uses the System Configuration to determine:

- Which instruments are on the bus.
- Available selections on the Source Control display.
- Maximum offset frequency (with or without an RF Analyzer).

**Table 6-1. Supported Equipment Table**

Name	Model
FFT Analyzer	HP 3561A
RF Analyzer	HP 3585A/B, 8566A/B, 8567A, 8568A/B, 71000
Interface	HP 11848A
Printer	Any HP-IB
Plotter	Any HP-GL Plotter (such as HP 98627A)
Function Generator	HP 3325A
RF Source	HP 8662A, 8663A, 8642A/B, 8656B, 8657A
Down Converter	HP 11729C
External Controller	Model number not used (address select code "100")
Voltmeter	HP 3478A
Frequency Counter	HP 5343A, 5384A, 5385A, 5386A, 5316A/B

## RF Sources

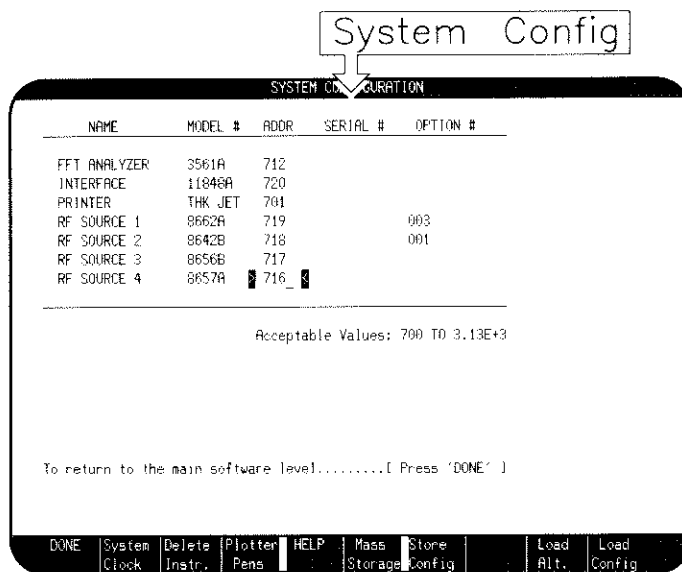

## Introduction

RF Sources are supported by the HP 3048A Phase Noise Measurement System to automate the measurements. The sources can be configured to set the output frequency, amplitude, and modulation over the HP-IB. The type of measurement to be made, the carrier frequency, output level, source drift, and noise level measured determine which RF Source best suits the application.

This section covers the HP supported RF Sources, the required parameter entries for configuring them, and their performance.

**Table 6-2. Source Specifications**

<b>Model</b>	<b>Frequency Range</b>	<b>Maximum Output Level</b>	<b>Maximum FM Peak Deviation</b>	<b>Comments</b>
HP 8662A	10 kHz to 1280 MHz	> +13 dBm (typ. +16 dBm)	200 kHz at 640 to 1280 MHz	Tuning with DC FM EFC, or 10 MHz A/B
HP 8663A	100 kHz to 2560 MHz	> +16 dBm (typ. +19 dBm)	400 kHz at 1280 to 2560 MHz	Tuning with DC FM EFC, or 10 MHz A/B
HP 8642A	100 kHz to 1057.5 MHz	> +16 dBm (typ. +19 dBm)	1.5 MHz at 528.7 MHz to 1057.5 MHz	Tuning with DC FM
HP 8642B	100 kHz to 2115 MHz	> +16 dBm (typ. +19 dBm)	3 MHz at 1057.5 to 2115 MHz	Tuning with DC FM
HP 8656B	100 kHz to 990 MHz	> +13 dBm (typ. +15 dBm)	99 kHz	Tuning with DC FM
HP 8657A	100 kHz to 1040 MHz	> +13 dBm (typ. +15 dBm)	99 kHz	Tuning with DC FM
HP 11729C with HP 8662/3	5 MHz in HP 3048A to 18 GHz	> +7 dBm (typ. +13 dBm)	$0.5 \times \frac{f}{10^7}$ at $\pm 10V$	Tuned by HP 8663A HP 8662A, EFC, 10 MHz A or DC FM

## Description

To configure a supported RF Source into the system, enter the Name (RF Source), Model Number, and HP-IB Address into the System Configuration Table. (If more than one RF source is needed in the system configuration, enter "RF Source 1", "RF Source 2"... to identify each source.) The Serial Number and Option Number of the RF Source may also be entered.

Under Define Measurement, configure the Source Control display block diagram to include the specified RF Source in the Ref. Source or Source block and press the  softkey to enable the System Control.

For a User's Source (DUT) under system control, you must enter the appropriate HP-IB string output statement in the System Control display. This allows the system to set the source's frequency, output level, and modulation (if any). Any HP-IB controlled source can be set up under system control. (Refer to *Source Control* in Chapter 2, Measurement Definitions, for further information on the HP-IB string for a Users DUT under system control).

Verify that the Detector/Disc. Input Frequency is correctly entered in the Instr. Param display. This entry sets the output frequency of a supported system controlled RF Source.

Verify that the correct Instrument Parameters are entered for RF Source that is also the VCO for a PLL measurement.

The application and the performance of the device being measured determines the selection of the RF Source. Each of the RF Sources supported by the HP 3048A has different qualities. For example, the HP 8662A has better phase noise performance close to the carrier than the HP 8642A, yet the HP 8642A has greater DC FM capabilities and a lower noise floor at offsets greater than 20 kHz from the carrier.

# Considerations When Choosing an RF Source

## HP 8662A/HP 8663A Performance

HP 8662/3A with 10 kHz DCFM, 10 MHz A, and EFC. (w/o Spurs)  
 [hp] 3040A Carrier: 640.E+6 Hz 23 Mar 1998 11:24:15 - 11:31:01

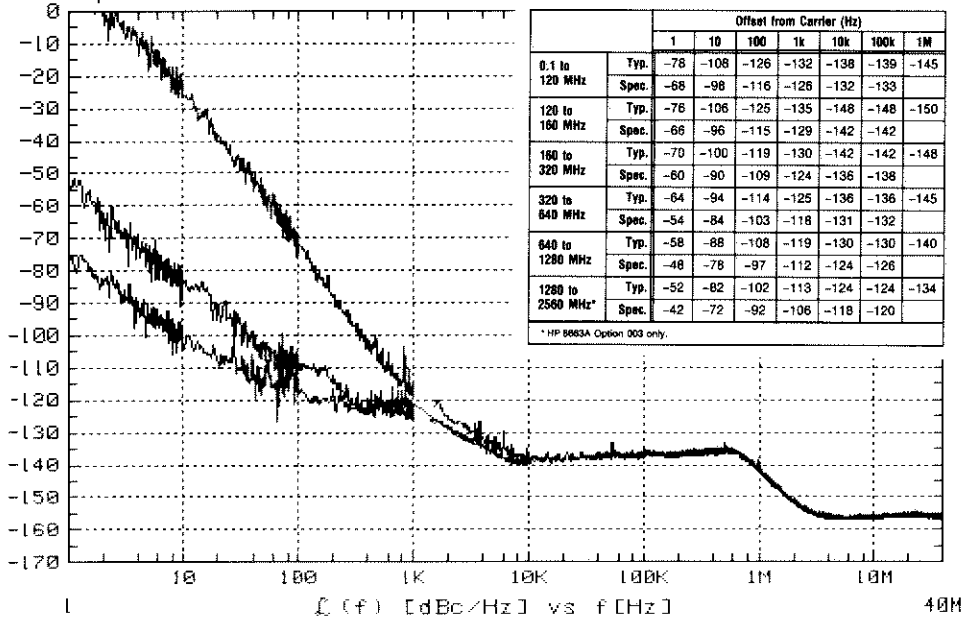

Figure 6-1. Graph of HP 8662A/8663A with EFC, DC FM, and 10 MHz A

## Tuning the HP 8662A or HP 8663A

The HP 8662A or HP 8663A can be used as the VCO in a phase lock loop using three different configurations. These configurations have different tuning characteristics and different levels of noise performance. The HP 8662A and HP 8663A have the best noise performance when tuned with EFC (electronic frequency control).

**EFC** tunes the internal HP 8662A/63A internal 10 MHz Reference Time Base. The internal time base tunes approximately 0.05 Hz/V over  $\pm 10V$  at 10 MHz. To calculate the VCO Tuning Constant using EFC, multiply 0.05 Hz by the 10 MHz multiple of the output frequency. For example, if the output is set to 900 MHz the VCO Tuning Constant would be:

$$90 \times 0.05 \text{ Hz} = 4.5 \text{ Hz/V}$$

Using the full Voltage Tuning Range of  $\pm 10V$  would result in a Peak Tuning Range of 45 Hz. (The internal time base typically has a tuning constant greater than 0.05 Hz/V.) Tuning with the EFC input will not degrade the noise performance of the HP 8662A/63A. The noise performance is specified for this mode.

**SOURCE CONTROL FOR MEASUREMENT USING A PHASE LOCK LOOP**

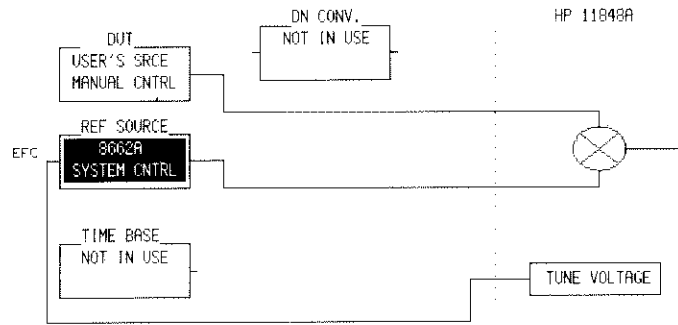

DONE	Control	EFC / DCFM	Tune Voltage	HELP	DUT	Ref. Source	Time Base	Down Convert
------	---------	------------	--------------	------	-----	-------------	-----------	--------------

**Figure 6-2. EFC Tune Voltage**

Center Volt.: 0 V.      VERIFY BEATNOTE < 1 MHz      V Range: +/- 2 V.

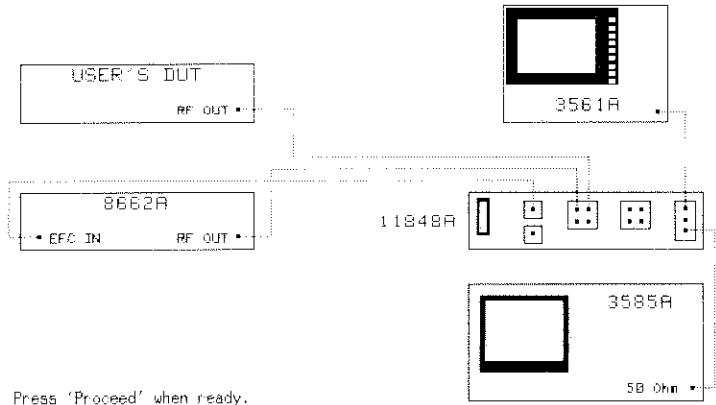

Proceed	Center Voltage	3561A Span	3585A Span	Abort
---------	----------------	------------	------------	-------

**Figure 6-3. EFC Connect Diagram**



**DC FM** can also be used to tune the HP 8662A/63A. DC FM provides wide peak tuning range for measuring sources that have high close-in noise or spurs, or that drift. DC FM will degrade the noise performance of the HP 8662A/63A. The noise performance of the HP8662A/63A is unspecified in DC FM mode. The graph shows typical performance.

**Table 6-3. Maximum Peak Deviation for the HP 8662/63A**

Center Frequency (MHz)	Maximum Peak Deviation DC Mode (kHz)	Center Frequency (MHz)	Maximum Peak Deviation DC Mode (kHz)
0.1 to 120	100	320 to 640	100
120 to 160	25	640 to 1280	200
160 to 320	50	1280 to 2560	400

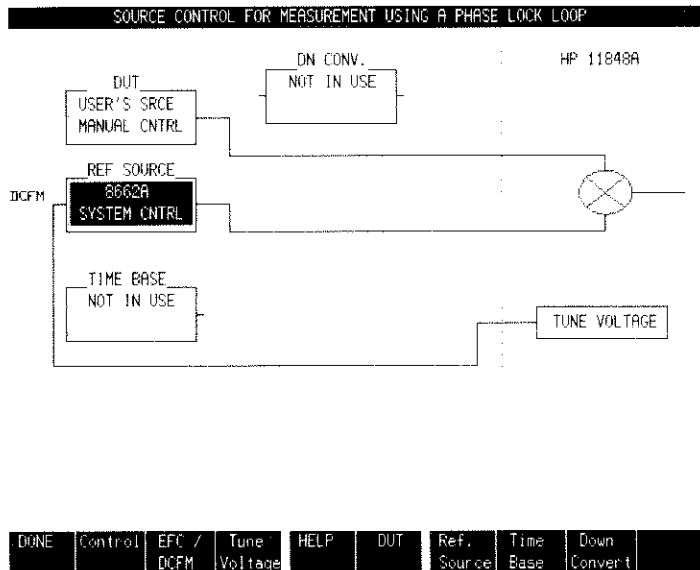

**Figure 6-4. DC FM Tune Voltage**

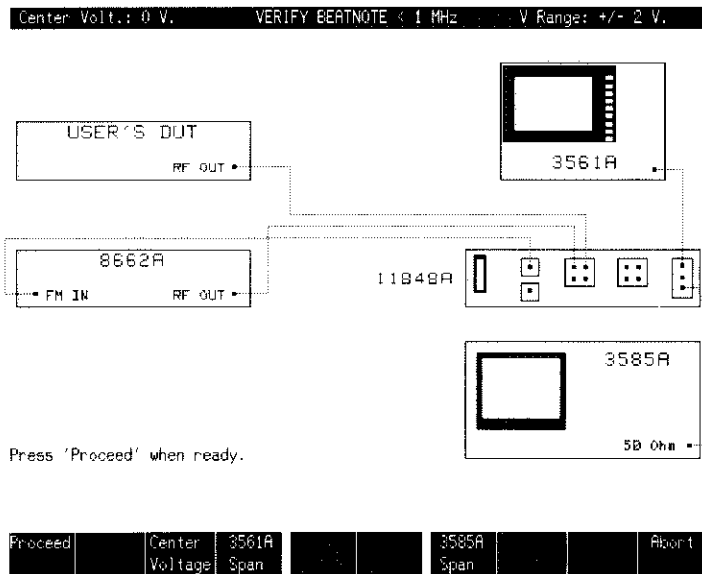

**Figure 6-5. DC FM Connect Diagram**

**10 MHz A** can be used as an external time base for the HP 8662A/63A to increase the tuning capability. The phase noise performance of the HP 11848A 10 MHz A is better than DC FM yet slightly worse than the HP 10811 internal reference for the HP 8662A/63A. 10 MHz A has a 10 Hz/V tuning constant and can be tuned over  $\pm 10V$ . To calculate the VCO Tuning Constant at the output frequency multiply 10 Hz by the 10 MHz multiple of the output frequency. For example, if the output is set to 900 MHz, the VCO Tuning Constant would be:

$$90 \times 10 \text{ Hz} = 900 \text{ Hz/V}$$

Using the full Voltage Tuning Range of  $\pm 10V$  would result in a Peak Tuning Range (PTR) of 9 kHz.

The amount of tuning allowed at the external reference input to the HP 8662/63A is restricted to a  $\pm 25$  ppm deviation and by the HP 3048A PLL bandwidth. 10 kHz is the maximum PTR allowed when tuning the external reference. Using the maximum tuning graph, Figure 6-6, determine the maximum PTR allowed at the time base and restrict the Voltage Tuning Range so it will not exceed that range. The PTR is the Tuning Constant of the reference time base multiplied up to the carrier frequency times the Voltage Tuning Range.

For example, 10 MHz B VCO Tuning Constant:

$$\frac{100 \text{ Hz}}{V} \times \frac{2 \text{ GHz}}{10 \text{ MHz}} = \frac{100 \text{ Hz}}{V} \times 200 = \frac{20 \text{ kHz}}{V}$$

Peak Tuning Range:

$$\frac{20 \text{ kHz}}{V} \times 0.5V = 10 \text{ kHz} = \text{Max PTR}$$

(This graph only applies to the HP 8662A/63A. Similar graphs must be determined for other RF sources when tuning their references.)

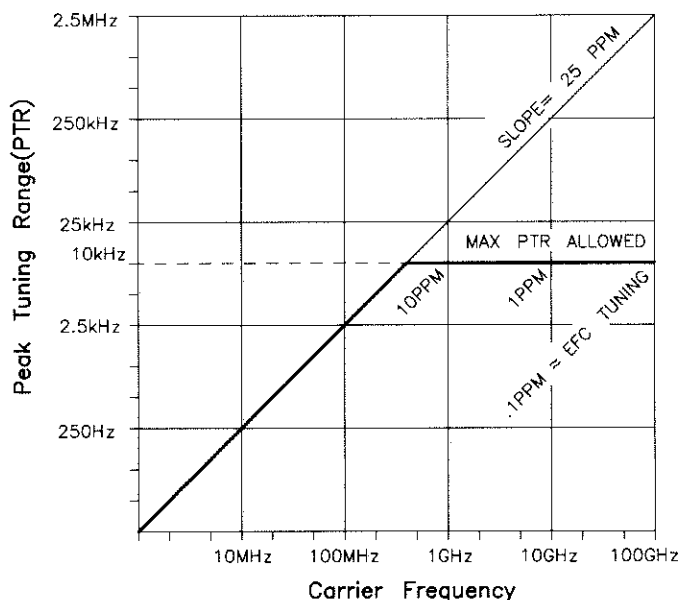

Figure 6-6. Graph of Maximum External Reference Tuning

---

## NOTE

The Source Control diagram and Connect diagram show the 10 MHz A front panel output connected to the Time Base input of the HP 8662A/63A. This output is at +16 dBm and will over drive the Time Base input if not attenuated. The correct input level to the HP 8662A/63A external Time Base is 7 to 10 dBm. The HP 11848A provides a rear panel 10 MHz A output of +7 dBm designed to be used for this application.

---

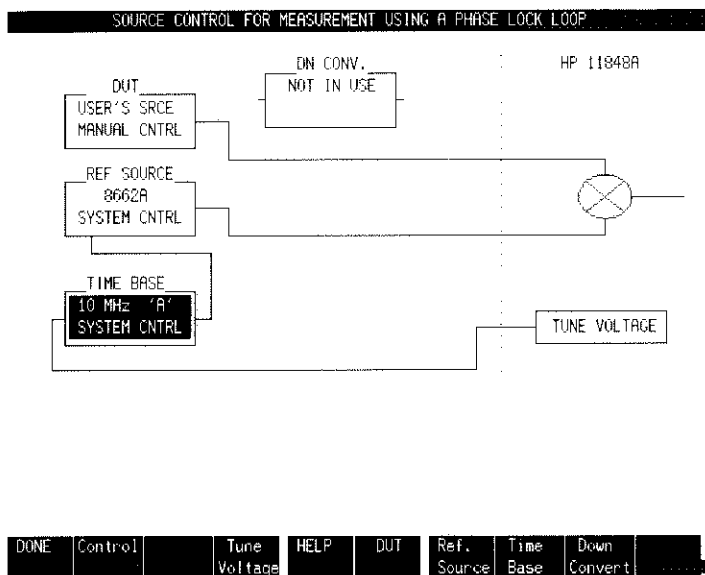

**Figure 6-7. Time Base Tune Voltage Using 10 MHz A**

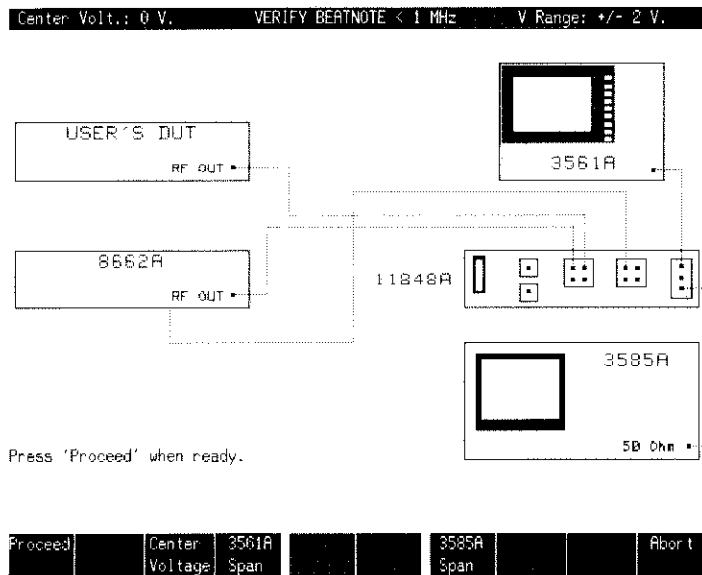

**Figure 6-8. 10 MHz A Time Base Connect Diagram**

**10 MHz B** has a tuning constant of 100 Hz/V and can be used as an external time base. However, 10 MHz B has little advantage over 10 MHz A due to the restriction for maximum PTR discussed previously. Because 10 MHz B has a wider tuning range, it also has a higher noise level.

**SOURCE CONTROL FOR MEASUREMENT USING A PHASE LOCK LOOP**

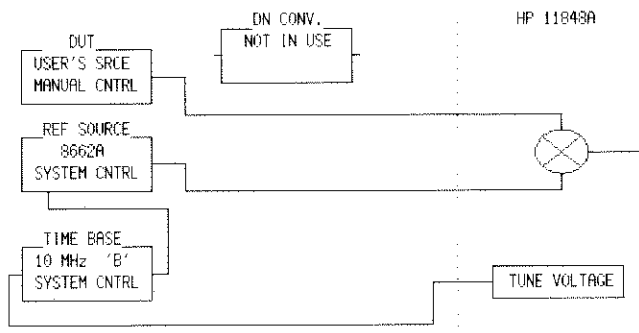

DONE	Control	Tune Voltage	HELP	DUT	Ref. Source	Time Base	Down Convert
------	---------	--------------	------	-----	-------------	-----------	--------------

**Figure 6-9. Time Base Tune Voltage Using 10 MHz B**

Center Volt.: -40.E-3 V. VERIFY BEATNOTE < 1 MHz V Range: +/- 2 V.

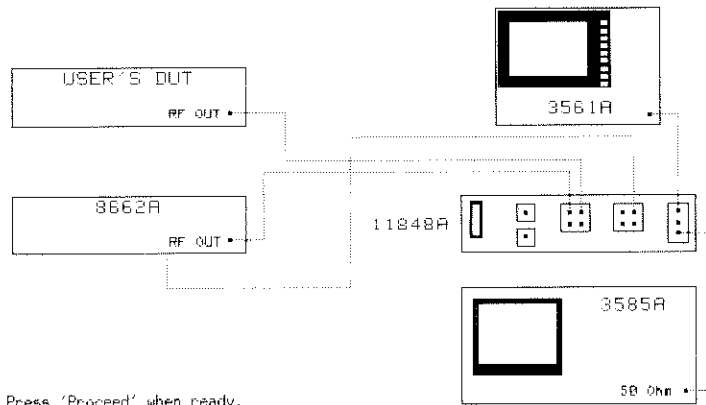

Press 'Proceed' when ready.

Proceed	Center Voltage	3561A Span	11848A Control	3585A Span	Abort
---------	----------------	------------	----------------	------------	-------

**Figure 6-10. 10 MHz B Time Base Connect Diagram**

# HP 8642A Performance

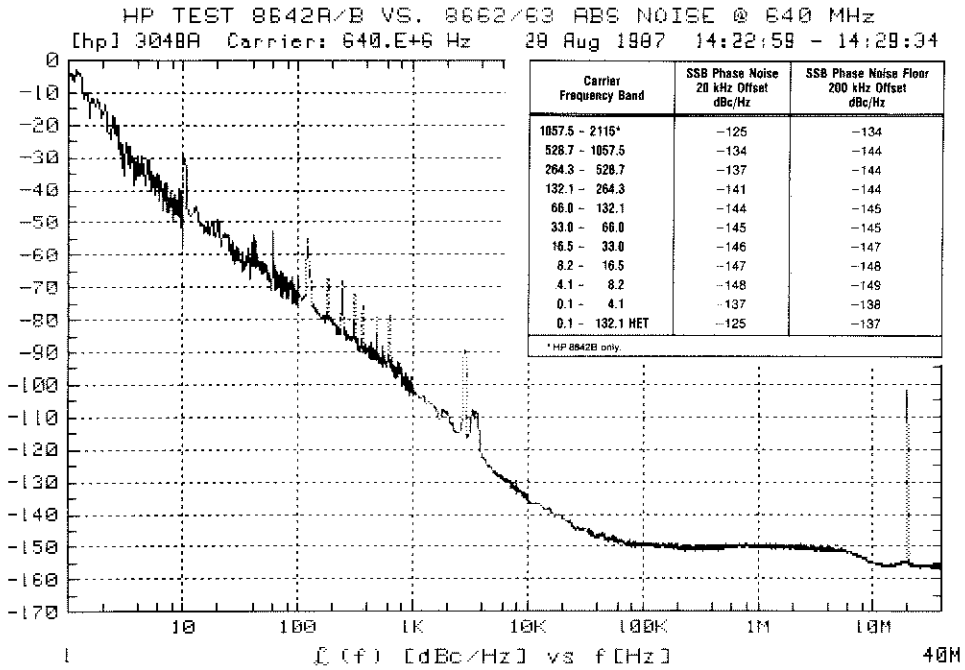

## Tuning the HP 8642A/B

**Table 6-4. Maximum Peak Deviation for the HP 8642A/B**

Carrier Frequency (MHz)	Maximum Deviation DC Coupled
0.1 to 132.1875 (HET)*	1.5 MHz
0.1 to 4.130859	93.8 kHz
4.130860 to 8.261718	11.7 kHz
8.261719 to 16.523437	23.4 kHz
16.523438 to 33.046875	46.9 kHz
33.046876 to 66.09375	93.8 kHz
66.093751 to 132.1875	187 kHz
132.187501 to 264.375	375 kHz
264.375001 to 528.75	750 kHz
528.750001 to 1057.5	1.5 MHz
1057.500001 to 2115 (8642B)	3 MHz
<p>* HET band will not be set under system control. It must be manually set by the user. Manually enter a deviation larger than that shown in the table above to instruct the HP 8642 to use the HET band.</p>	



# HP 8656B Performance

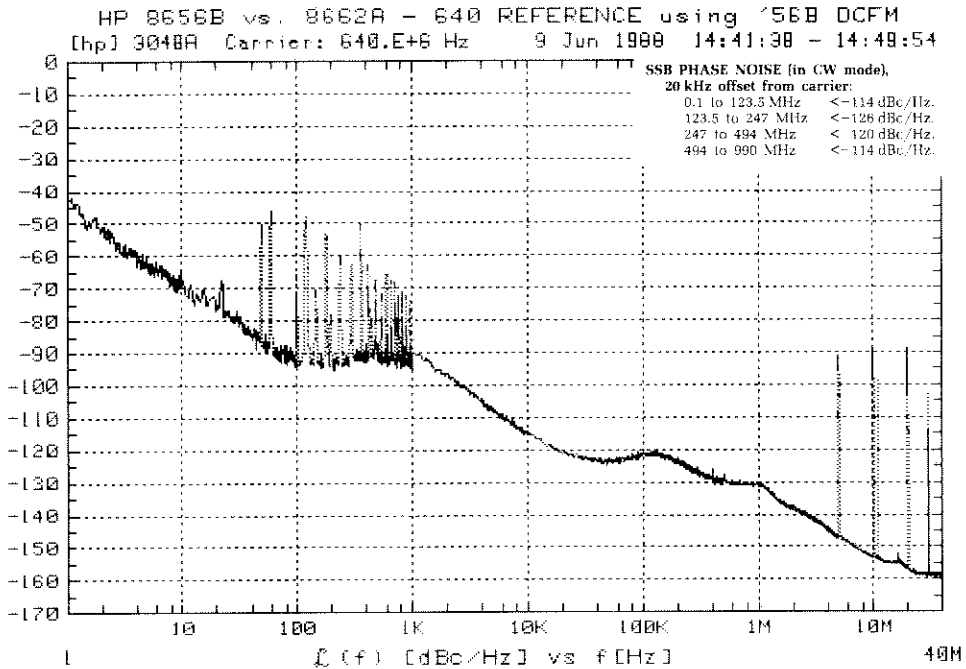

## Tuning the HP 8656B

Table 6-5. Maximum Peak Deviation for the HP 8656B

Center Frequency (MHz)	Maximum Peak Deviation DC Mode (kHz)
0.1 to 123.5	99
123.5 to 247	50
247 to 494	99
494 to 990	99

# HP 8657A Performance

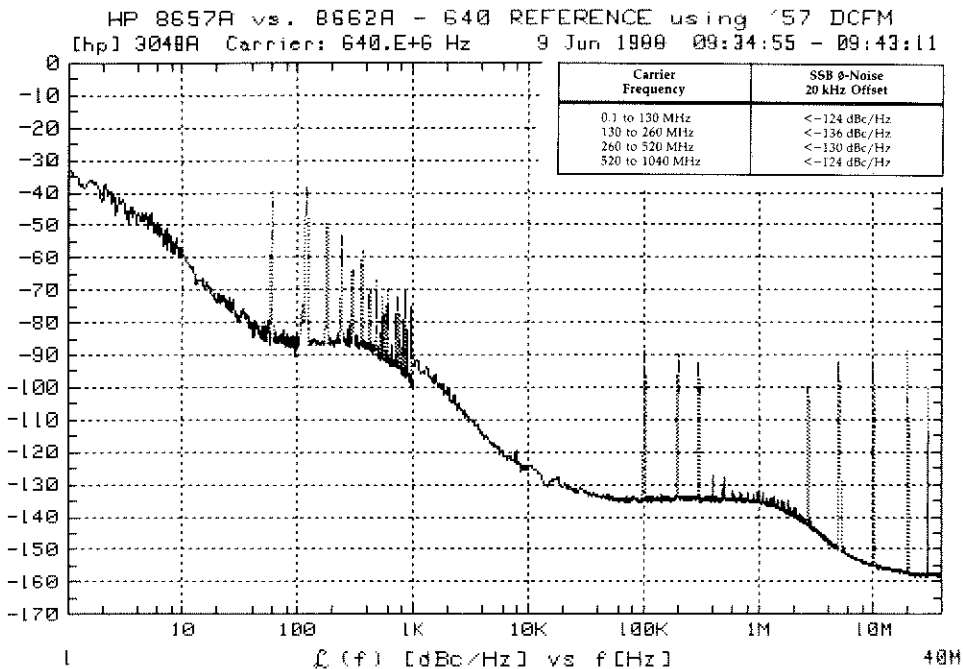

## Tuning the HP 8657A

Table 6-6. Maximum Peak Deviation for the HP 8657A

Center Frequency (MHz)	Maximum Peak Deviation DC Mode (kHz)
0.1 to 130	99
130 to 260	50
260 to 520	99
520 to 1040	99

# HP 11729C Performance

HP TEST 11729C/8662/63 VS. 11729C/8662/63 ABS NSE  
 [hp] 3048A Carrier: 2.1167E+9 Hz 20 Aug 1987 13:00:21 - 13:14:55

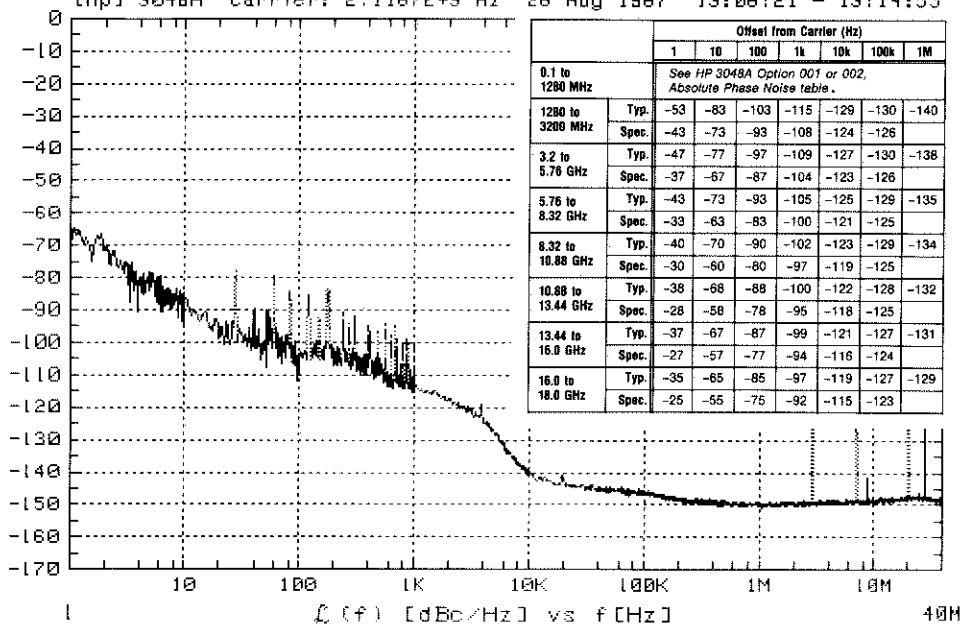

The HP 11729C Carrier Noise Set, when used with an HP 8662A or HP 8663A, is a very good reference source with a frequency range of 100 kHz to 18 GHz. For a complete description of the HP 11729C refer to *Down Converters* in Chapter 5, Special Functions.

**SOURCE CONTROL FOR MEASUREMENT USING A PHASE LOCK LOOP**

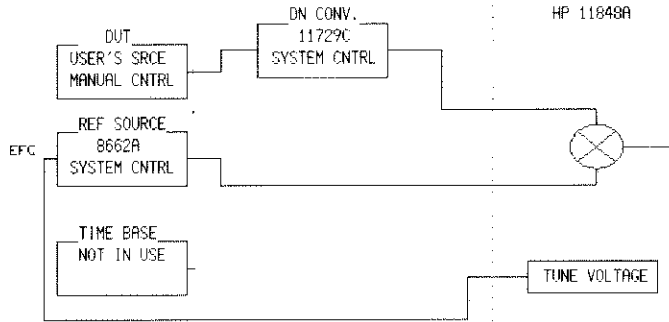

DONE	Control	EFC / DCFM	Tune Voltage	HELP	DUT	Ref. Source	Time Base	Down Convert
------	---------	------------	--------------	------	-----	-------------	-----------	--------------

**Figure 6-11. HP 11729C/HP 8662A with EFC Tune Voltage**

Center Volt.: -40.E-3 V. VERIFY BEATNOTE < 1 MHz V Range: +/- 2 V.

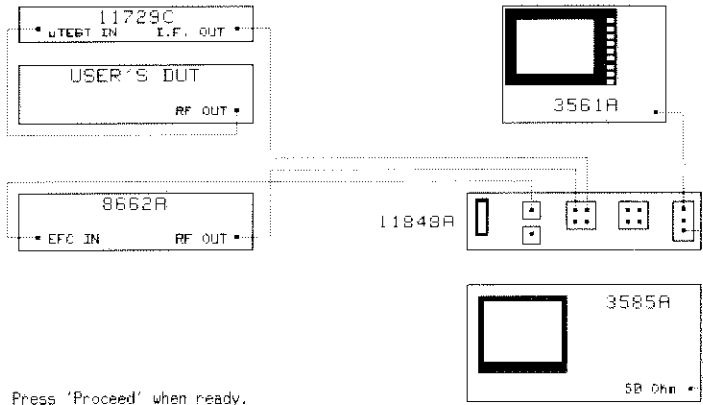

Press 'Proceed' when ready.

Proceed	Center Voltage	3561A Span	11848A Control	3585A Span	Abort
---------	----------------	------------	----------------	------------	-------

**Figure 6-12. HP 11729C/HP 8662A Connect Diagram**

# RF Analyzers

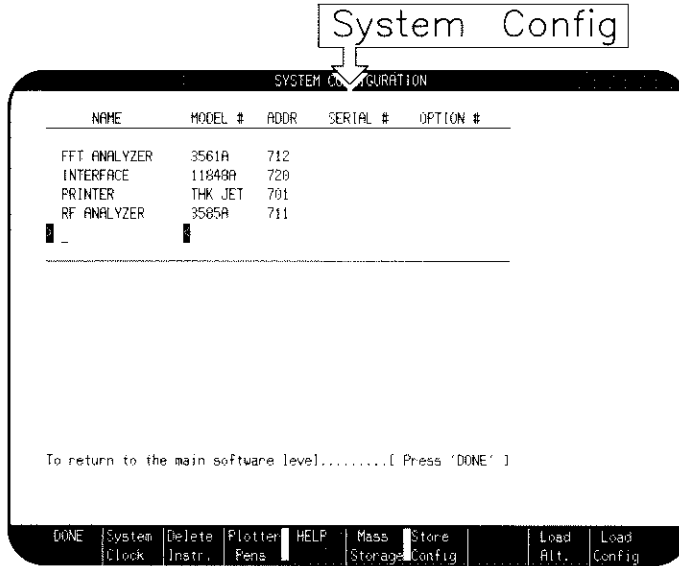

## Introduction

Using an RF Analyzer extends the system's measurement offset range to 40 MHz. RF Analyzers also allow the use of a wider Peak Tuning Range, up to 200 MHz maximum.

Most free-running sources (RF or microwave) require an RF analyzer.

The basic consideration for choosing an RF analyzer is the frequency range for secondary uses. The HP 3048A supports the RF Analyzers listed in Table 6-7.

**Table 6–7. Supported RF Analyzers**

<b>Model</b>	<b>Frequency Range</b>	<b>Other Considerations</b>
HP 3585A/B	20 Hz to 40 MHz	Allows complete generation of calibration files, Synthesized LO, Tracking Generator
HP 8566A/B	100 Hz to 22 GHz	Must verify calibration data by performing the Noise Flatness Performance Test. Synthesized LO. Although this analyzer cannot generate New CALDATAHI > 100 kHz, the Cal Data is verified and/or corrected by performing the Noise Flatness Test.
HP 8567A	1 kHz to 1500 MHz	Must verify calibration data by performing the Noise Flatness Performance Test. Synthesized LO. Although this analyzer cannot generate New CALDATAHI > 100 kHz, the Cal Data is verified and/or corrected by performing the Noise Flatness Test.
HP 8568A/B	100 Hz to 1500 MHz	Must verify calibration data by performing the Noise Flatness Performance Test. Synthesized LO. Although this analyzer cannot generate New CALDATAHI > 100 kHz, the Cal Data is verified and/or corrected by performing the Noise Flatness Test.
HP 71000	Varies with model	Must verify calibration data by performing the Noise Flatness Performance Test. Synthesized LO. Although this analyzer cannot generate New CALDATAHI > 100 kHz, the Cal Data is verified and/or corrected by performing the Noise Flatness Test. Although a tracking generator is available, it is not supported by HP 3048A software for generation of calibration files.

## Description

To configure an RF Analyzer into the system, enter the Name (RF Analyzer), Model Number, and HP-IB Address of the RF Analyzer into the System Configuration Table. The serial number and option numbers may also be entered for the RF Analyzer.

Connect the 50 $\Omega$  Input of the RF Analyzer to the "Spectrum Analyzer" PHASE DETECTOR OUTPUT port of the HP 11848A Phase Noise Interface.

---

### NOTE

If an RF Analyzer is not connected to the HP 11848A, the Spectrum Analyzer output must be terminated in 50 $\Omega$  .

---

The system generates a 100 kHz Calibration Tone to calibrate the RF Analyzer to match the HP 3561A prior to a new measurement. This tone is used for all of the supported analyzers except the HP 3585A/B. (The HP 3585A/B accuracy is comparable to that of the HP 3561A.) An error message is displayed if the calibration factor measured during RF Analyzer Calibration is  $> 5$  dB.

The calibration is performed when the system is first "booted-up" and run with the RF Analyzer in the System Configuration menu. If you change RF Analyzers, use the BASIC command "SCRATCH C" to clear the present calibration factor. Perform the New Measurement function to recalibrate the new RF Analyzer.

## **RF Analyzer Segment Table Modification**

The following information deals with the RF analyzer segment table. The values in this table will affect the accuracy of the measured results, so care must be exercised when changing the values in this table.

### **Segment Table Field Descriptions**

Table 6–8 shows the default RF segment table as it is shipped with the HP 3048A System Software. The table can be modified to include up to 20 defined segments.



You can set all fields on the RF segment table, but you must also be able to set the values on the particular RF Analyzer you are using. The accuracy of the measurement is dependent on the parameters in the RF Segment Table. The RF Segment Table is stored with a stored Test File.

**Table 6-8. RF Analyzer Default Segment Table**

Plotted Range (Hz)				Measurement Range (Hz)		Min. Av'g	BW (Hz)	Video BW (Hz)	Sweep Time
100+3	-	500E+3	0	-	500E+3	1	3.E+3	10	20
500+3	-	5E+6	0	-	5E+6	1	10.E+3	30	20
5E+6	-	40E+6	0	-	40E+6	1	30.E+3	100	20

## Plotted Range

The Plotted Range defines which data will be plotted on a graph. It can be the entire Measurement Range or a subset of the Measurement Range. The Plotted Range is usually selected so that all the segments make a continuous plot of the measured data.

## Measurement Range

The Measurement Range is the range over which the analyzer will take the measured data. The Measurement Range frequency must be less than or equal to 40 MHz for all segments specified.

## Bandwidth

The Bandwidth is the resolution bandwidth used for a particular segment. The specified bandwidths should be at least as small as those specified in the default segment table, but can be of finer resolution if required. User RF bandwidths should be specified as 1 kHz, 3 kHz, 10 kHz, 30 kHz, etc. These bandwidths are available on all supported RF analyzers. If your

particular RF spectrum analyzer supports other bandwidths they can be used. Refer to your RF spectrum analyzer Operating and Service manual for a list of the available bandwidths.

---

### NOTE

Do not use bandwidths greater than 3 kHz at a frequency of 100 kHz.

---

### Video Bandwidth

The video bandwidth entry should be specified by the following equation for accurate noise measurements.

$$\text{Video Bandwidth} = \frac{\text{Resolution Bandwidth}}{300}$$

### Sweep Time

The value of the sweep time will, more than anything else, affect the accuracy of the measured results. The following procedure should be used to determine reasonable sweep time values.

1. Determine the RF analyzer's default sweep time. This can be done by setting the RF analyzer to the parameters specified in the segment table for the specific segment.
2. Perform a sweep on a known signal at the default sweep time and measure the amplitude of the signal.
3. Divide the default RF analyzer sweep time by 2.5 and set the RF analyzer to this new sweep time.

4. Perform the sweep on the known signal again with the new sweep time setting and measure the amplitude of the known signal.
5. Compare the results of the two measurements. If the new value is within 0.6 dB of the original value, the new sweep time will not affect the system accuracy.

---

### **NOTE**

If the above criterion is not met, the system accuracy specification will apply only to the measured noise and not to spurs.

---

Using this procedure, the value of the sweep time can be iterated for the fastest possible measurement time and the greatest accuracy. Faster sweep times will cause spurs to be measured low but noise measurements will not be affected. Note that since the HP 3048A computation time for the RF segments may be 20 to 30 seconds, faster sweeps may not improve overall measurement speed significantly. The default segment table has been set up to optimize measurement speed while maintaining system accuracy.

## Considerations When Using an RF Analyzer

The System is limited to a Peak Tuning Range of less than 500 kHz without an RF analyzer configured. Sources with high rates of drift and microwave sources may be difficult to measure without an RF Analyzer.

Calibration Tones required for Single Sided Spur and Double Sided Spur calibration of the Phase Detector Constant are limited to less than 100 kHz without an RF Analyzer.

Performance Tests are limited to 100 kHz offset without an RF Analyzer. The Noise Flatness performance test is only required when a supported RF Analyzer is used.

The HP 11848A Spectrum Analyzer output must maintain a  $50\Omega$  impedance. When an RF Analyzer is not used, this port must be terminated into  $50\Omega$ .

To optimize sweep time, the system sets the RF Analyzer one step out of its calibrated range forcing the UNCAL light on. This will not affect the system accuracy.

# Down Converters

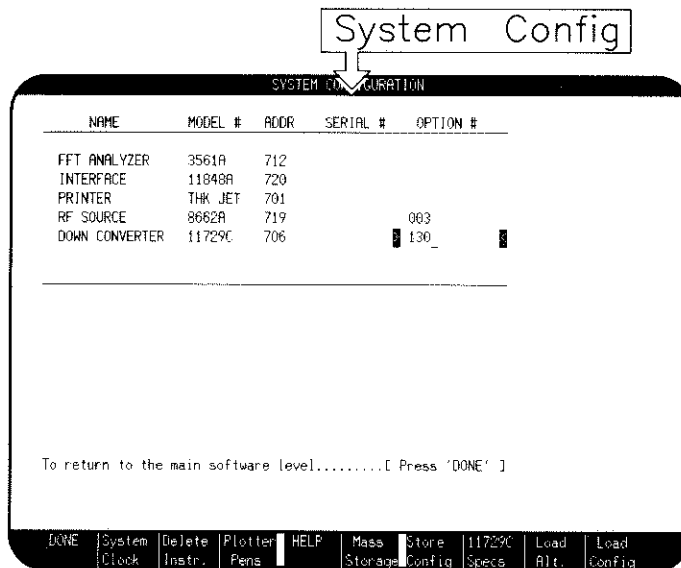

## Introduction

Down Converters are used to translate the frequency of a source to a lower frequency that is compatible with tuneable low noise reference sources. The HP 3048A supports any manually controlled down converter, including the HP 11729C which is also supported under system control.

This section describes how the down converter is configured in the HP 3048A System, specifically the HP 11729C, and the considerations to be considered when using a down converter to make noise measurements.

## Description

The HP 3048A can be configured with a down converter under manual or system control. Typically down converters translate the frequency of the DUT to a lower frequency. The critical parameter to the HP 3048A is Phase Detector Input frequency. Because the down conversion is done prior to the phase detector, the system is essentially measuring a lower frequency source. When downconverting a signal by mixing against a local oscillator, the noise of the DUT is translated to the IF without any change in the noise level except for added noise due to the LO. When manually controlling the down converter you must input the down converted frequency (IF) as the Detector Input Frequency in the Instrument Parameter display. If the Detector Input Frequency is less than 95 MHz, the system will automatically enable the 2 MHz Low Pass Filter internal to the HP 11848A Interface. With the 2 MHz LPF enabled, the measured offset range is limited to 2 MHz.

The Carrier Frequency entered in the Instrument Parameters display should reflect the correct DUT frequency so the graphic display of the Carrier Frequency is correct. The entered Carrier Frequency is used:

- To label the graph,
- To compute Sigma vs. Tau and  $S_y(f)$ , and
- To derive the correct frequency band selection and Detector Input Frequency for a system controlled HP 11729C.

### HP 11729C Carrier Noise Test Set

The HP 11729C is the only down converter fully supported under system control. When configured under System Control the system automatically selects the correct comb line filter on the HP 11729C and determines the correct Detector Input Frequency from the entered Carrier Frequency.

$$\text{Detector Input Frequency} = |\text{Carrier Frequency} - \text{Center Frequency of Comb Line}|$$

The HP 11729C creates a series of comb line frequencies based on a 640 MHz reference. These comb lines have specified band pass filters centered on multiples of 640 MHz up to a 17.28 GHz comb line. If non-standard filters are configured in the HP 11729C, they can be specified in the System Configuration Table under 11729C Specs. The 640 MHz reference can be provided externally or internally (self oscillation). Self oscillation mode is an unspecified reference source without voltage control. Typically the HP 11729C uses the specified 640 MHz output of the HP 8662A Option 003 or the HP 8663A Option 003 as a reference for the comb line generator. The HP 8662A/63A used with the HP 11729C provides a low noise, specified microwave VCO reference.

**HP-IB address switches** are located on the rear of the HP 11729C and are typically set to 06 (706).

**To configure the HP 11729C** into the System Config. Table enter:

- “Down Converter” into the NAME column.
- “11729C” into the MODEL # column.
- “706” (if appropriate) into the ADDR column.
- “130” into the OPTION # column, if the HP 11729C includes option 130, the AM Detector.
- The Serial Number and Option Number may also be entered for the Down Converter.
- Press the 11729C Specs softkey to define optional special filters for the HP 11729C. The filters are defaulted to the standard HP 11729C selection.

SPECIFICATION OF L.O. FREQUENCIES FOR HP11729C

Enter the 'N' values of the HP11729C.....

[ 0 ]	[ ]	X	640 MHz	= 0	Hz
[ 3 ]	[ ]	X	640 MHz	= 1.92E+9	Hz
[ 7 ]	[ ]	X	640 MHz	= 4.48E+9	Hz
[ 11 ]	[ ]	X	640 MHz	= 7.04E+9	Hz
[ 15 ]	[ ]	X	640 MHz	= 9.6E+9	Hz
[ 19 ]	[ ]	X	640 MHz	= 12.16E+9	Hz
[ 23 ]	[ ]	X	640 MHz	= 14.72E+9	Hz
[ 27 ]	[ ]	X	640 MHz	= 17.28E+9	Hz

Acceptable Values: 0 TO 99

To return to 'System Configuration'.....[ Press 'DONE' ]



Figure 6-13. HP 11729C Standard Bands (Comb Lines)

**System Control** is established for the HP 11729C in the Source Control display after the HP 11729C has been properly defined in the System Configuration Table. The Down Convert softkey in the Source Control display will access the HP 11729C from the System Configuration Table and allow you to place it under system control by pressing the Control softkey when the Down Converter block is activated.

**Instr. Params** enter the correct Carrier Frequency into the Instrument Parameter display to enable the system to select the correct band filter and to determine the appropriate Detector/Disc. Input Frequency.



# Considerations When Using a Down Converter

## Absolute System Noise Floor

The HP 11729C measurement system noise floor is dependent on the RF reference source(s) used. System noise for the phase detector method is a composite of the noise on the multiplied 640 MHz reference, the residual noise of the down converter, and the noise of the RF tunable source at the phase detector input (front panel noise of the HP 8662A/8663A). For the frequency discriminator method, system noise is a composite of the noise on the multiplied 640 MHz signal plus the noise of the HP 11729C and the discriminator circuit noise. System noise can be described by:

$$\mathcal{L}_{system} = 10 \log(N^2 \times 10^{\frac{\mathcal{L}_1}{10}} + 10^{\frac{\mathcal{L}_2}{10}} + 10^{\frac{\mathcal{L}_3}{10}})$$

*This equation is valid to 100 kHz. At 1 MHz and above, the first term does not contribute due to the SAW filter in the HP 11729C.*

*where  $N$  = center frequency of selected filter/640 MHz*

*$\mathcal{L}_1$  = absolute SSB phase noise of 640 MHz ref. signal (dBc/Hz)*

*$\mathcal{L}_2$  = absolute SSB phase noise of 5 to 1280 MHz ref. signal (dBc/Hz)*

*$\mathcal{L}_3$  = residual noise of the HP 11729C (dBc/Hz)*

## Specified Noise

The HP 11729C, when used with the HP 8662A/63A Option 003, provides a specified 640 MHz reference with EFC. Although the HP 11729C can be used in the self oscillation mode the phase noise performance is not guaranteed.

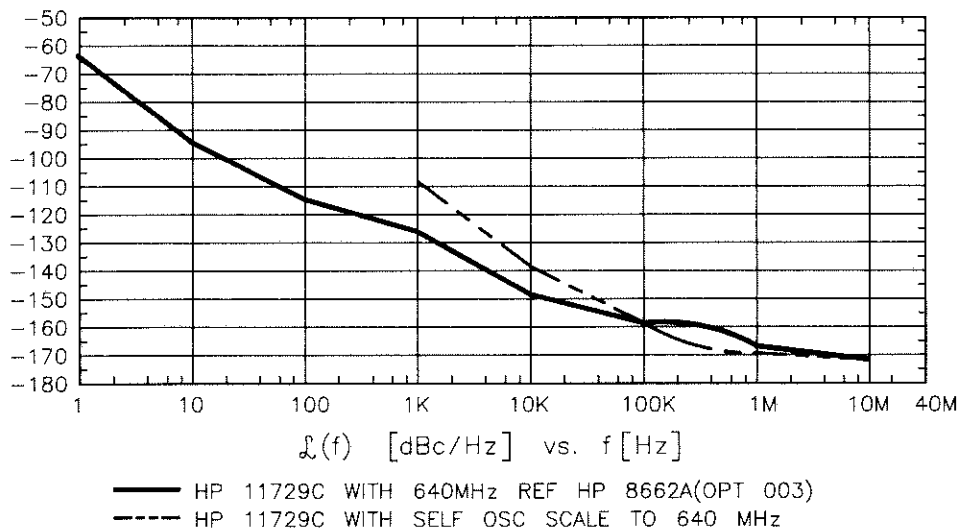

**Figure 6-14. 640 MHz Noise Floor of  
HP 11729C/8662A vs. 11729C Self Oscillation**

## DC FM vs. EFC or 10 MHz A/B

Making measurements using a PLL requires that one of the sources being measured is a VCO. A VCO can be used to track or tune at the Carrier Frequency or at the down converted (IF) frequency. In both cases a variety of block diagrams can be used.

**Tuning the DUT** can be done directly to phase lock the DUT to the reference source. Although this technique is acceptable it is not common due to hardware constraints at high frequencies.

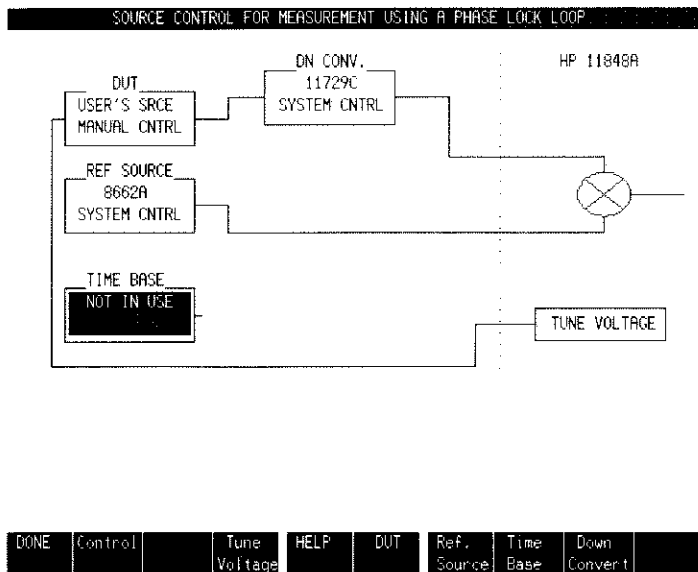
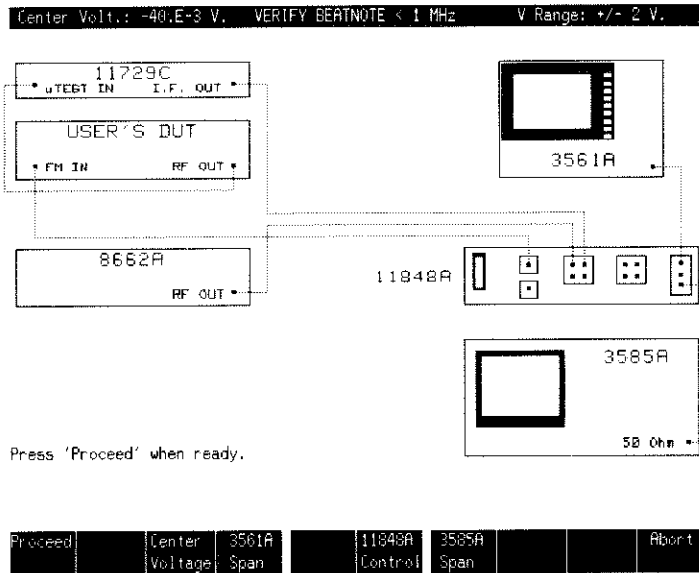

Figure 6-15. DUT Tune Voltage



**Figure 6-16. Tuning the DUT Connect Diagram**

**Tuning the down converter reference** (HP 11729C 640 MHz input) will also tune the Carrier Frequency. You must scale the Tuning Constant directly to the Carrier Frequency. The HP 11729C, when used with the HP 8662A with EFC control to measure a 10 GHz source, will tune the comb line about  $\pm 500$  Hz.

$$\frac{10 \text{ GHz}}{10 \text{ MHz}} \times \frac{0.05 \text{ Hz}}{V} \times 10V = \frac{500 \text{ Hz}}{V}$$

where:  $\frac{10 \text{ GHz}}{10 \text{ MHz}}$  = Ratio of Carrier Frequency to Time Base

$\frac{0.05 \text{ Hz}}{V}$  = Estimated Tuning Constant of Time Base

10V = Voltage Tuning Range

$\frac{500 \text{ Hz}}{V}$  = Peak Tuning Range

Using the HP 11848A internal 10 MHz A source as the time base for the HP 8662A will extend the tuning of the 640 MHz reference, thereby increasing the amount of tuning at the carrier frequency. Refer to the *Tuning Characteristics* table in Chapter 8, Quick Reference for guidelines for tuning with 10 MHz A.

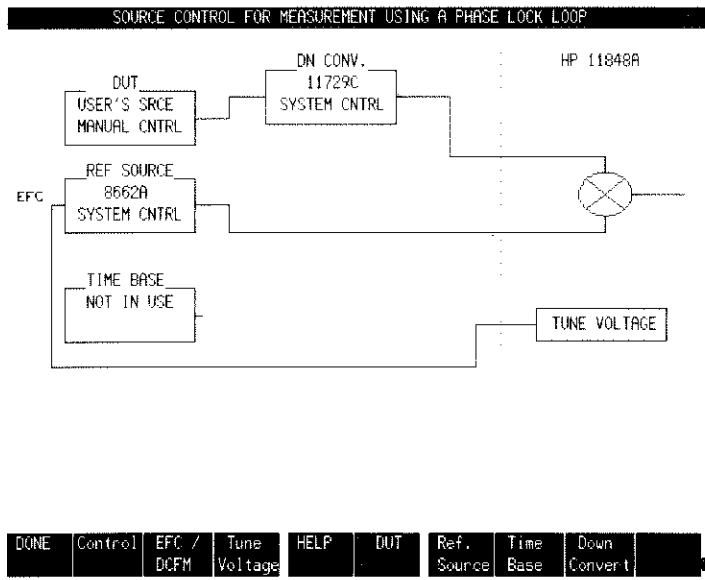
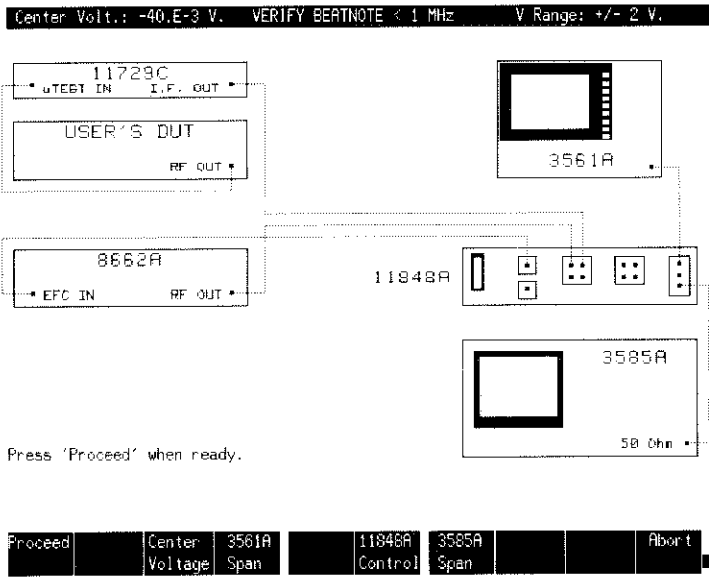
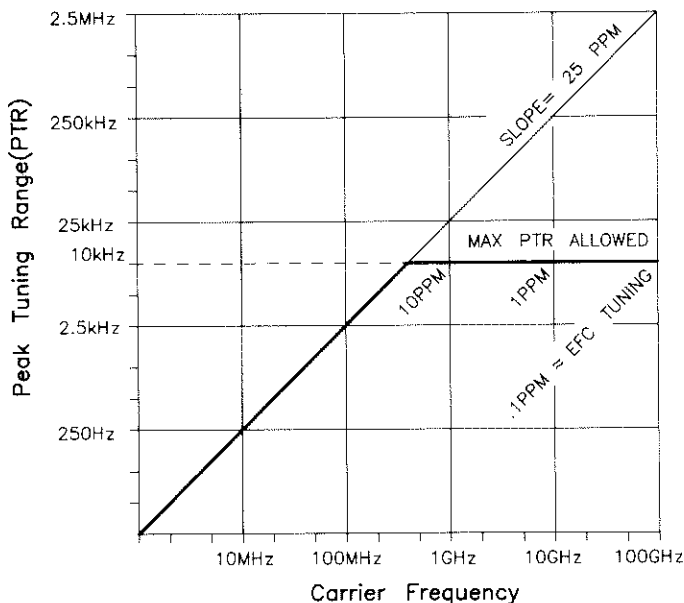

Figure 6-17. EFC Tune Voltage Tuning with HP 8662A 640 MHz Reference

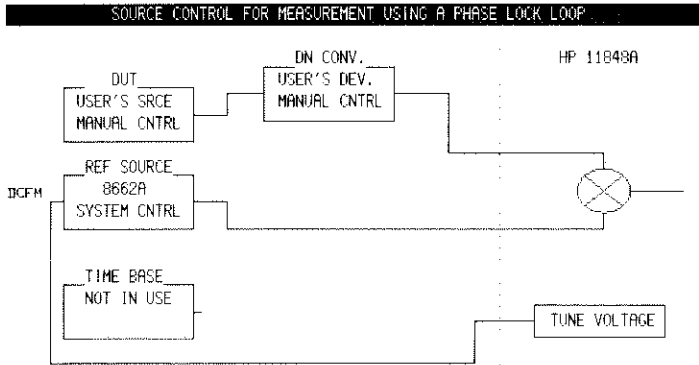

**Figure 6-18. EFC Tuned 640 MHz Reference Connect Diagram**

**Tuning the reference RF Source** Tuning the reference at the down converted frequency is the most common method for creating a PLL with the maximum PTR. In this case the reference VCO can be tuned using DC FM or EFC. The maximum PTR allowed is limited by the following graph.



**Figure 6-19. Graph of Limits for Maximum Peak Tuning Range Using EFC**



DUNE	Control	EFC / DCFM	Tune Voltage	HELP	DUT	Ref. Source	Time Base	Down Convert
------	---------	------------	--------------	------	-----	-------------	-----------	--------------

**Figure 6-20. DC FM Reference Source Tune Voltage**

Center Volt.: -40.E-3 V. VERIFY BEATNOTE < 1 MHz V Range: +/- 2 V.

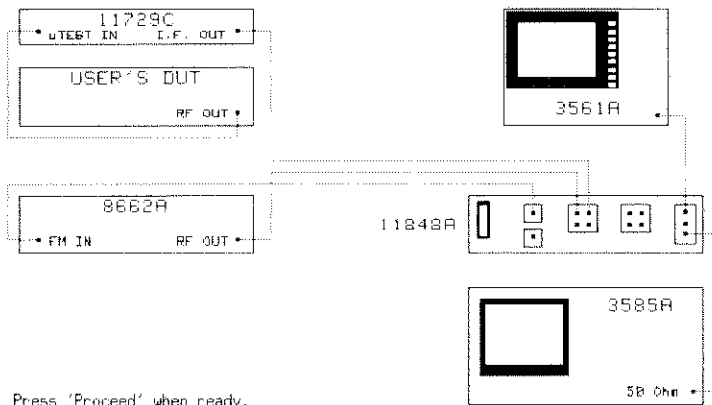

Proceed	Center Voltage	3561A Span	11848A Control	3585A Span	Abort
---------	----------------	------------	----------------	------------	-------

**Figure 6-21. Reference Source Tuning Connect Diagram**



## **AM measurements using the HP 11729C Option 130**

For AM Noise measurements please refer to the Signal Source Applications chapter “AM Noise Using an HP 11729C” in the HP 3048A Operating Manual.

## **Considerations When Using a Down Converter**

The HP 11729C with the HP 3048A cannot measure frequencies within 5 MHz of the selected comb line frequency.

The HP 11729C typically causes the measured noise to tip up close to 40 MHz offset. This is due to the parametric amplification of noise by the step recovery diode.

Spurs are not specified for the HP 11729C.

# Frequency Counters

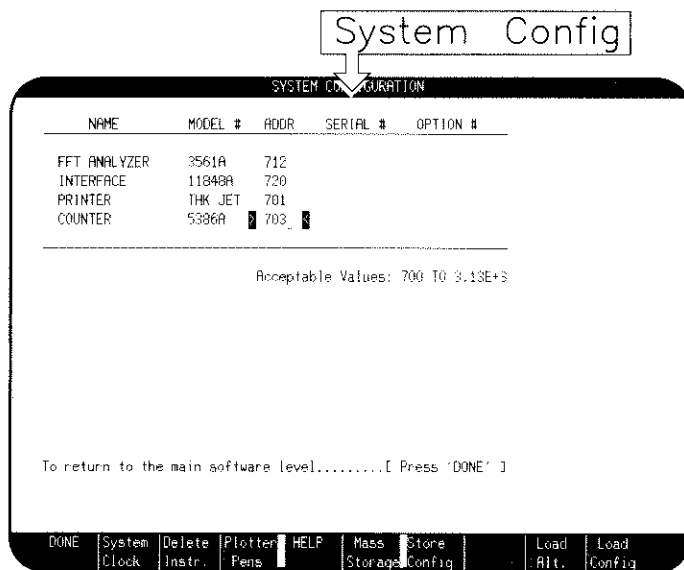

## Introduction

The HP 3048A Phase Noise Measurement System supports several frequency counters. A frequency counter can be used to zero-beat the sources and measure the VCO Tuning Constant. Using a Frequency Counter decreases the time the system takes to find the beatnote, determine the tuning constant, and zero-beat the sources.

The system supports the following Frequency Counters:

- HP 5343A
- HP 5385A
- HP 5316A
- HP 5384A
- HP 5386A
- HP 5316B

## **Description**

To configure a Frequency Counter into the system, enter the Name (Counter), Model Number, and HP-IB Address into the System Configuration Table. The Serial Number and Option Number may also be entered for the Frequency Counter.

The Counter is not represented on the Source Control Diagram or on the Connect Diagram.

Connect the Counter to the Aux Monitor port on the HP 11848A. If you also wish to use an oscilloscope to monitor the Phase Detector Output, use a tee adapter to connect both the oscilloscope and the counter to the HP 11848A Aux. Monitor port.

Connect the system's HP-IB to the Frequency Counter and verify that the system recognizes it in the System Configuration Table.

## **Considerations when using a Frequency Counter.**

Using a Counter decreases the time the system takes to find the Beatnote, determine the VCO Tuning Constant, and Zero-Beat the sources.

Counters cannot tolerate sources with large amounts of drift or erratic noise. If an error message occurs indicating that the system cannot zero the beatnote or measure the VCO Tuning Constant, remove the counter from the System Configuration Table.

# Digital Voltmeters

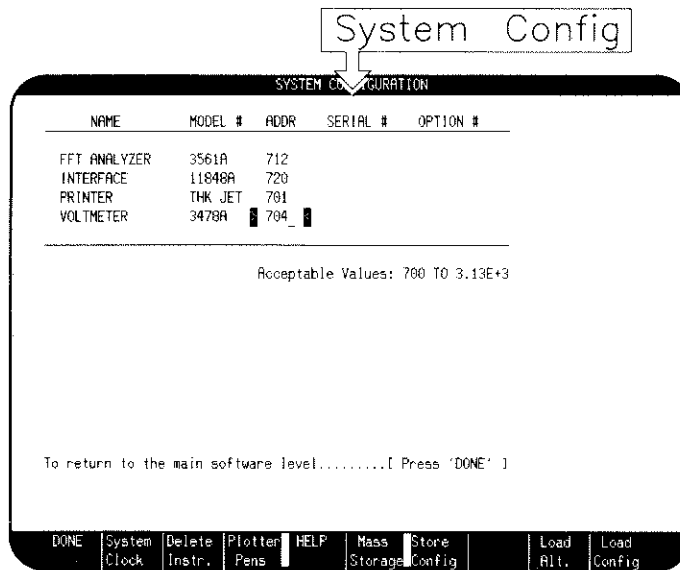

## Introduction

The HP 3048A Phase Noise Measurement System supports the HP 3478A Multimeter for making the DC voltage measurements normally done by the HP 3561A Dynamic Signal Analyzer. A supported digital voltmeter reduces measurement time.

The current HP 3048A Phase Noise Measurement System Software only supports the HP 3478A Multimeter.

## Description

The time required for making a measurement is reduced by using a voltmeter in place of the voltage measuring capability of the HP 3561A. Measurements such as the  $\pm$ DC Peak (Phase Detector) calibration and verify beatnote, Out of Lock, and Overload can be done more quickly with the voltmeter.

To configure a Voltmeter into the system, enter the Name (Voltmeter), Model Number (3478A), and the HP-IB Address into the System Configuration Table.

Connect the voltmeter to the HP 11848A Phase Detector Output through a BNC tee adapter at the To 3561A Input. The HP 3561A and the HP 3478A are connected in parallel and both have high impedance inputs. The measurement results will not be affected by having the voltmeter connected at this point.

Connect the voltmeter to the HP-IB.

## Considerations When Using a Voltmeter

Using a common ground on the voltmeter (not isolated) may cause a ground loop, thereby increasing line spurs.

## Controllers

Model	Display	Memory	Video Interface	Compatibility Card	Keyboard
HP 310	35731A	3 Mbytes	Standard	Optional	
HP 320	98782A	4 Mbytes	98542A	No	
HP 9836A	Standard	3 Mbytes	Standard	No	
HP 9836C	Standard	3 Mbytes	Standard	No	
HP 82315B	Standard VGA	3 Mbytes* 3 Mbytes	Standard VGA	No No	Standard Standard
HP 332	Standard	4 Mbytes	Standard	No	Standard
HP R332	Standard	4 Mbytes	NA	No	Standard
HP 370	Various	4 Mbytes	Various	No	Standard
HP 318M	Standard	4 Mbytes	NA	No	Standard
HP 319C	Standard	4 Mbytes	NA	No	Standard

\* The Vectra Viper controller HP 82315B Requires the HP 82305A Memory Expansion Kit.

## Introduction

The HP 3048A Phase Noise Measurement System supports several controllers (computers) in a variety of configurations. The availability of new and improved controllers and their configurations constantly increases the possible supported controllers. Therefore, the following is a list of the known supported controllers, although many more may function with the HP 3048A System.

## Considerations When Using a Controller

Some controllers are faster than others, therefore the measurement times may be decreased by making calculations and displaying graphics faster.

Some controllers place the softkeys in different locations than illustrated in this manual. For example, the HP 9836 softkeys are displayed in two rows versus one as shown. Some Vectras with Viper Cards move the shifted softkeys to alpha keys.

The current HP 3048A software REV. A.01 requires a large carriage printer when using the HP 350 computer.

# Mass Storage Devices

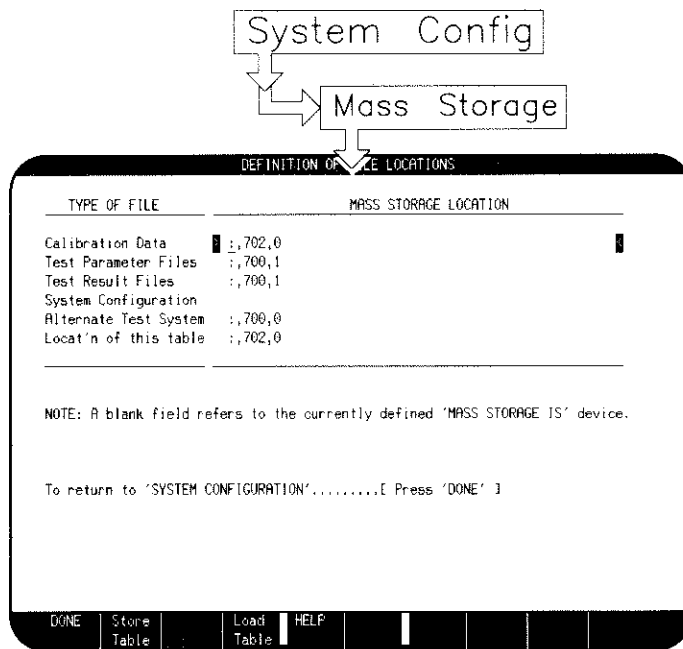

## Introduction

The HP 3048A Phase Noise Measurement System software is only available on 3½ inch floppy disc. The system therefore, requires a 3½ inch disc drive to load the software. Alternate mass storage devices such as hard disc or SRM's (shared resource management) can be used if the HP 3048A System software programs are copied correctly from the 3½ inch discs.

This section will give you an overview of the copy routines and list the supported mass storage devices.



## Description

The Mass Storage device is configured in the Mass Storage Table accessed through the System Configuration Table. You can specify the Mass Storage location for each of the following files:

- Calibration Data
- Test Parameter Files
- Test Result Files
- System Configuration
- Alternate Test System
- Location of this table

The system requires a double sided  $3\frac{1}{2}$  inch disc drive compatible with HP-IB to load the software. Hard discs or SRM's can be used after the software is copied from the  $3\frac{1}{2}$  inch discs.

The HP 3048A System software package includes a Utilities disc that provides a copy routine. This routine allows you to copy the HP 3048A software onto a hard disc or SRM. The Utilities disc contains instructions on the copy routine.

## Considerations for Using Mass Storage Devices

Disc drives are slow to load the system software as compared to a hard disc. Data files are limited to 99 entries at any one mass storage device and double sided discs usually hold about 50 files per disc.

Sometimes the best solution is to store the HP 3048A program files on a hard disc or SRM and use the disc drive for the data files.

If the HP 3048A Phase Noise Measurement System is calibrated off-site or disconnected from a hard disc or SRM mass storage device, the Calibration Data will need to be restored to the Mass storage device. The calibration data will most likely be on a floppy disc. To restore the Calibration Data to the system:

- Change the Mass Storage location for Calibration Data and use the new data disc to boot the system, or load the Calibration data using the Manage Caldata softkey. (Refer to 3048 System Checks in Chapter 5 Special Functions for information on loading Calibration data.)

# Plotter

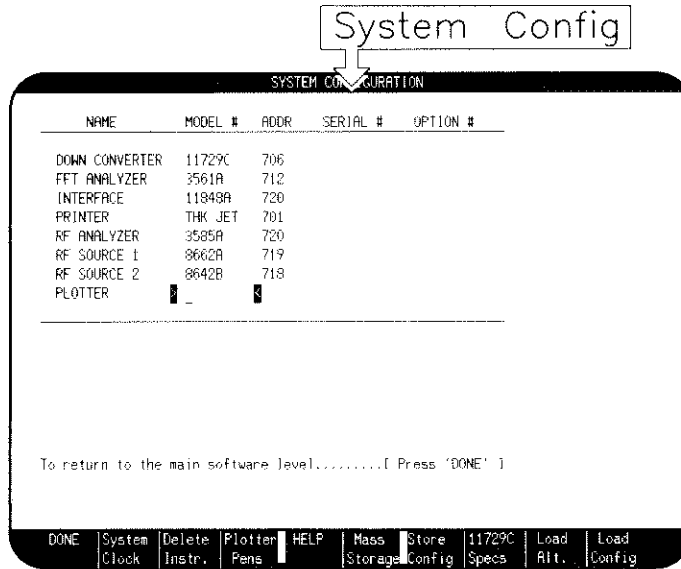

## Introduction

The Plotter feature of the HP 3048A System allows clear, large size, plotted results to be output to a plotter or to an external color monitor. The use of color pens allows easy comparison of noise plots. Using the color pens can also allow easy identification of spurs. The Plotter feature does not prevent the use of a system printer.

The System supports any HP-GL plotter (such as the HP 7574A). An HP 98627A Color Monitor is also supported by the System.

## Description

To configure a Plotter in the System, return to the Main Software Level and press the **System Conf** softkey. Enter the Name (Plotter), Model Number, and HP-IB Address. When you tab past the Plotter address entry in the System Configuration display, the Plotter Pens softkey will appear.

The Plotter-Pen Specification display, accessed by pressing **Plotter Pens**, allows you to choose the pen colors for plotting the lines on the results graph. A different color may be chosen for the grid lines (Grid Pen), the text labels for the graph (Label Pen), the noise trace (Trace Pen), and the spurs (Spur Pen). Type in a pen number next to each pen choice. Press the **Done** softkey when you are finished specifying the plotter pens.

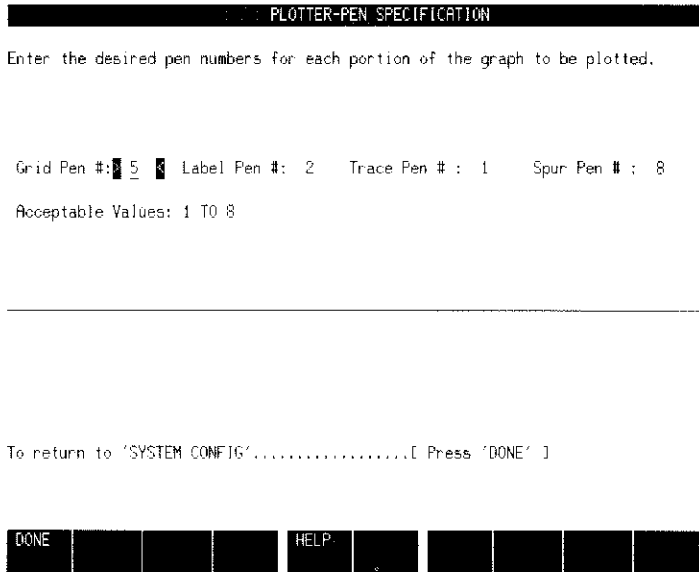

Figure 6-22. Plotter Pens Display

To plot the Results Graph as displayed on the screen, return to the Main Software Level and press the **Access Graph** softkey. When the Access Graph softkeys appear, hold down the SHIFT key and press the **Redraw Graph** softkey. This outputs the graph to the plotter or color monitor.

To configure the HP 98627A Color Monitor into the system instead of a plotter, return to the Main Software Level and press the **System Conf** softkey. Enter the Name: Plotter, Model Number: 98627A, and HP-IB Address: 2800. Specify the plotter pens as when using the plotter. Press the **HELP** softkey in the Plotter-Pen Specification display to access the list of pen numbers and pen colors for the Color Monitor.

## Considerations When Using a Plotter

When using a color monitor in place of a Plotter, double check all of the monitor's hardware connections to insure that they are correct.

The default select code for the HP 98627A color interface card is 28. The HP-IB address is derived by multiplying the select code by 100. If the select code for your interface is not 28, either change the HP-IB address in the System Configuration display to match the interface card, or change the interface card select code.

Slope lines cannot be output to a plotter.

Marker display can be output to a plotter by holding down the SHIFT key and pressing **Plot Data** or **Redraw Graph**.

## System Clock

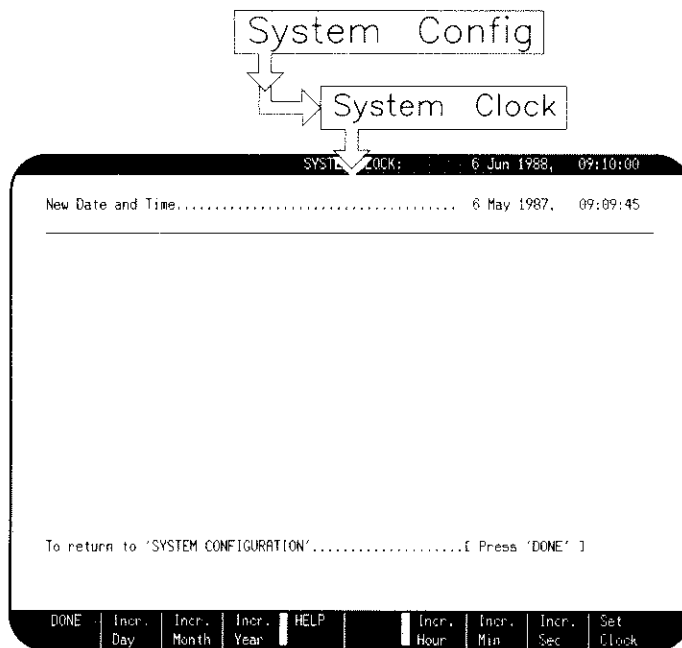

## Introduction

The System Clock places the the date and time of measurement on the Results Graph. The System Clock also records the time it takes to complete the measurement. (Measurement time begins when the graticule is drawn on the screen and ends after the last span has been plotted, calibration time is not included.) Both the start time and stop time of the measurement are displayed.

## Considerations for the System Clock

Time information is stored with the Results Files. When plotting multiple noise graphs the system will display the date and time from last data file loaded.

## How to Set the System Clock

The following steps describe the procedure for setting the System Clock.

1. Return to the Main Software Level and press the **Sys. Config.** softkey.
2. When the System Configuration softkeys are displayed, press the **System Clock** softkey. The softkeys in the System Clock display increment the fields that appear at the top of the display.

For example, if the month displayed at the top of the screen is Apr, press **Incr. Month** once to set the month to May. (To decrement the units, hold down the SHIFT key and press the desired softkey.)

# Load Alternate Program

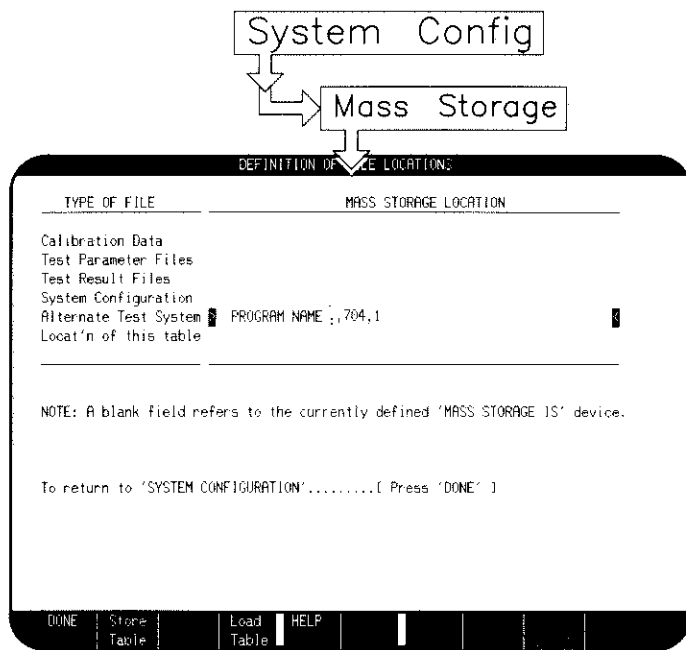

## Introduction

The HP 3048A Phase Noise Measurement System allows you to define an alternate software program in the System Configuration Table. This Alternate Program can be loaded from the HP 3048A System Configuration Table by pressing the **Load Alt.** softkey. This allows you to share the controller with other programs, specifically with the Signal Generator Performance Test Software (HP 11808A).



## Description

To access the Load Alternate Program from the Main Software Level press the **System Config.** softkey. When the System Configuration softkeys are displayed, press the **Mass Storage** softkey to access the mass storage media location table. Move the cursor to the "Alternate Test System" row and enter the name of the file and the mass storage location of the alternate program.

Press the **Done** softkey to return to the System Configuration Table where the **Load Alt.** softkey now appears. Pressing this softkey loads the alternate program.

Once the Alternate Program is loaded the HP 3048A System Software will have to be re-loaded for HP 3048A Noise Measurements. (The HP 11808A software also includes a **Load Alt.** softkey. This key is intended to load the HP 3048A software.)

## Additional Equipment

The following is a list of additional equipment that may be useful with the system.

### Modulation Analyzers

HP 8901A/B	150 kHz to 1300 MHz
HP 8902A	150 kHz to 1300 MHz

### Power Meters

HP 436 with HP 8482A Sensor	100 kHz to 4.2 GHz input range -30 to +20 dBm
HP 438 with HP 8482A Sensor	100 kHz to 4.2 GHz input range -30 to +20 dBm

### AM Detector

HP 33330D	10 MHz to 26 GHz, P max = +23 dBm Low Barrier Schottkey Diode
-----------	--

### AM Detector Filter

HP 3048A Option K21	1 Hz to 40 MHz Positive and Negative Detector Polarity
---------------------	---

### Attenuators

HP 8493	Series of fixed attenuators
HP 8494	1 dB step attenuator
HP 8495	10 dB step

## **Amplifiers**

HP 3048A Option K22

Dual RF Amplifier

HP 8447A

Preamp

HP 8447D

Preamp

HP 8447E

Amplifier

Specified Phase Noise

9 dB gain, NF Typically < 7 dB

5 to 1500 MHz

Output Power > 15 dBm

26 dB gain 0.1 to 400 MHz

NF < 5 dB, output power > 6 dBm

26 dB gain 0.1 to 1300 MHz

NF < 8.5 dB, output power > 7 dBm

22 dB gain 0.1 to 1300 MHz

NF < 11 dB, output power > 15 dBm

## **Phase Shifter**

HP 11609A Option K08

Packaged line stretcher

2.5 to 3.4 ns variable delay

## **0° Power Splitters**

MCL ZFSC-2-5

10 to 1500 MHz

MCL ZAPD-21

500 MHz to 2 GHz

Merrimac PDM-27-10G

1.5 to 18 GHz

## **Couplers**

MCL ZFDC-20-5

0.1 to 2000 MHz, 19.5 dB coupler

MCL ZFDC-10-2

10 to 1000 MHz, 10.75 dB coupler

NARDA 4227-16

1.7 to 26.5 GHz, 16 dB coupler

## **DC Blocks**

HP 3048A Option K23

DC blocking filter for noise measurements  
on power supplies

NARDA 4563

Inside/Outside DC block

500 MHz to 18 GHz

NARDA 562

Noise Suppressor

10 MHz to 12.4 GHz

## Printers

Any HP-IB printer can be used.

When using a large screen controller with greater horizontal and vertical display limits than the printer, use the Horizontal Position and Vertical Position features in the Define Graph menu. These features scale the plot on the controller's display, allowing the printer to print the entire plot.

If scaling functions are not used, part of the plot may be cut off when printing on narrow carriage printers such as the ThinkJet Printer.

1 Approximate HP 3048A Phase Noise Floor vs. R Port Signal Level

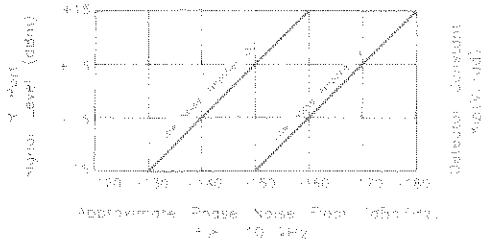

2 HP 3048A Phase Noise Floor and Region of  $\Delta f(f)$  Validity

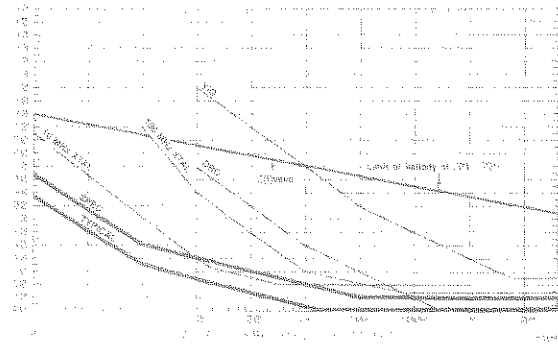

3 Phase Noise Level of Various HP Sources

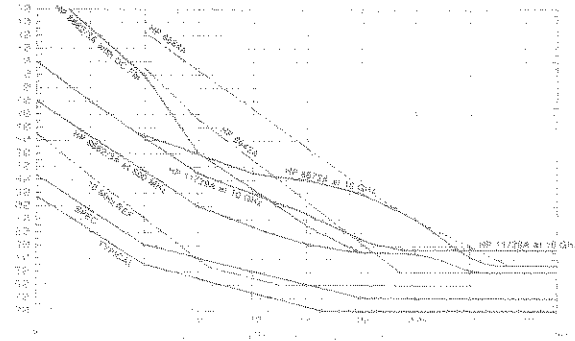

4 Increase in Measured Noise as Reference Source Noise Approaches OUT noise

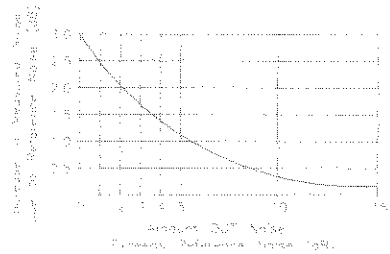

5 3dB Calibration

Equation: Phase Detector Constant vs. Detector Voltage vs. Input Power

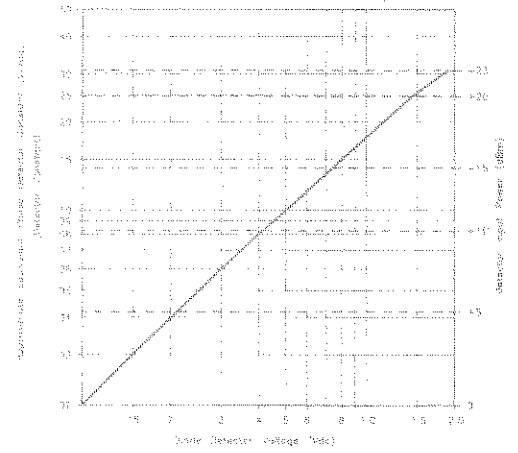

6 Approximate Sensitivity of Delay Line Discriminator

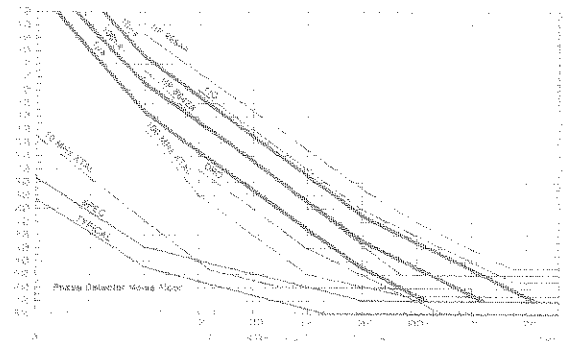

## 7 Voltage Controlled Source Tuning Requirements

Peak Tuning Range (PTR)  $\approx$  Voltage Tuning Range  
X VCO Tuning Constant

Min. PTR = .1 Hz

Max. PTR = 500 kHz (200 MHz with  
an RF Analyzer).

Drift Tracking Range = Allowable Drift During  
Measurement.

100% Peak-to-Peak Tuning Range  $\approx$  PTR

Center Voltage Tuning Range  $\approx$  PTR

Drift Tracking Range  $\approx$  20% PTR

Range  $\approx$  10% PTR

Range  $\approx$  5% PTR

Range  $\approx$  2% PTR

100% Voltage Tuning Range

## 8 Voltage Tuning Range

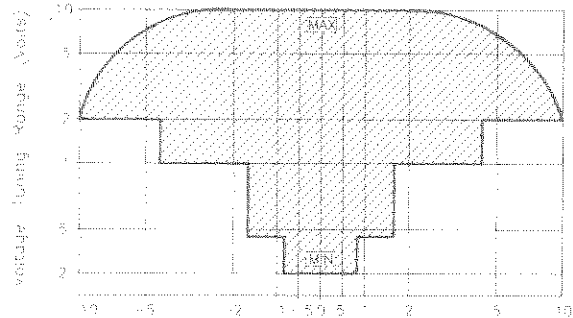

Center Voltage of VCO Tuning Curve (Volts)

Center Voltage  $\pm$  1 Voltage Tuning Range  $\leq$  12V

## 9 Tuning Characteristics of Various VCO Source Options

VCO Source	Center Freq. (MHz)	Tuning Range (MHz)	Center Voltage (Volts)	Voltage Tuning Range (Volts)	Max. Jitter (ps)	Tuning Constant (MHz/V)
HP 33012A	100	10	0	10	100	10
HP 33013A	100	10	0	10	100	10
HP 33014A	100	10	0	10	100	10
HP 33015A	100	10	0	10	100	10
HP 33016A	100	10	0	10	100	10
HP 33017A	100	10	0	10	100	10
HP 33018A	100	10	0	10	100	10
HP 33019A	100	10	0	10	100	10
HP 33020A	100	10	0	10	100	10
HP 33021A	100	10	0	10	100	10
HP 33022A	100	10	0	10	100	10
HP 33023A	100	10	0	10	100	10
HP 33024A	100	10	0	10	100	10
HP 33025A	100	10	0	10	100	10
HP 33026A	100	10	0	10	100	10
HP 33027A	100	10	0	10	100	10
HP 33028A	100	10	0	10	100	10
HP 33029A	100	10	0	10	100	10
HP 33030A	100	10	0	10	100	10
HP 33031A	100	10	0	10	100	10
HP 33032A	100	10	0	10	100	10
HP 33033A	100	10	0	10	100	10
HP 33034A	100	10	0	10	100	10
HP 33035A	100	10	0	10	100	10
HP 33036A	100	10	0	10	100	10
HP 33037A	100	10	0	10	100	10
HP 33038A	100	10	0	10	100	10
HP 33039A	100	10	0	10	100	10
HP 33040A	100	10	0	10	100	10
HP 33041A	100	10	0	10	100	10
HP 33042A	100	10	0	10	100	10
HP 33043A	100	10	0	10	100	10
HP 33044A	100	10	0	10	100	10
HP 33045A	100	10	0	10	100	10
HP 33046A	100	10	0	10	100	10
HP 33047A	100	10	0	10	100	10
HP 33048A	100	10	0	10	100	10
HP 33049A	100	10	0	10	100	10
HP 33050A	100	10	0	10	100	10
HP 33051A	100	10	0	10	100	10
HP 33052A	100	10	0	10	100	10
HP 33053A	100	10	0	10	100	10
HP 33054A	100	10	0	10	100	10
HP 33055A	100	10	0	10	100	10
HP 33056A	100	10	0	10	100	10
HP 33057A	100	10	0	10	100	10
HP 33058A	100	10	0	10	100	10
HP 33059A	100	10	0	10	100	10
HP 33060A	100	10	0	10	100	10
HP 33061A	100	10	0	10	100	10
HP 33062A	100	10	0	10	100	10
HP 33063A	100	10	0	10	100	10
HP 33064A	100	10	0	10	100	10
HP 33065A	100	10	0	10	100	10
HP 33066A	100	10	0	10	100	10
HP 33067A	100	10	0	10	100	10
HP 33068A	100	10	0	10	100	10
HP 33069A	100	10	0	10	100	10
HP 33070A	100	10	0	10	100	10
HP 33071A	100	10	0	10	100	10
HP 33072A	100	10	0	10	100	10
HP 33073A	100	10	0	10	100	10
HP 33074A	100	10	0	10	100	10
HP 33075A	100	10	0	10	100	10
HP 33076A	100	10	0	10	100	10
HP 33077A	100	10	0	10	100	10
HP 33078A	100	10	0	10	100	10
HP 33079A	100	10	0	10	100	10
HP 33080A	100	10	0	10	100	10
HP 33081A	100	10	0	10	100	10
HP 33082A	100	10	0	10	100	10
HP 33083A	100	10	0	10	100	10
HP 33084A	100	10	0	10	100	10
HP 33085A	100	10	0	10	100	10
HP 33086A	100	10	0	10	100	10
HP 33087A	100	10	0	10	100	10
HP 33088A	100	10	0	10	100	10
HP 33089A	100	10	0	10	100	10
HP 33090A	100	10	0	10	100	10
HP 33091A	100	10	0	10	100	10
HP 33092A	100	10	0	10	100	10
HP 33093A	100	10	0	10	100	10
HP 33094A	100	10	0	10	100	10
HP 33095A	100	10	0	10	100	10
HP 33096A	100	10	0	10	100	10
HP 33097A	100	10	0	10	100	10
HP 33098A	100	10	0	10	100	10
HP 33099A	100	10	0	10	100	10
HP 33100A	100	10	0	10	100	10

## 10 Peak Tuning Range Required Due to Noise Level

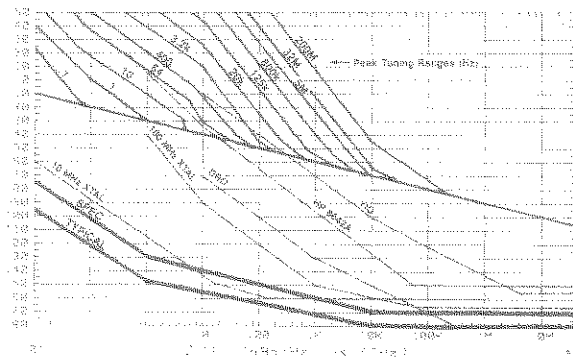

## 11 Closed Phase-Lock-Loop Bandwidth vs. Peak Tuning Range

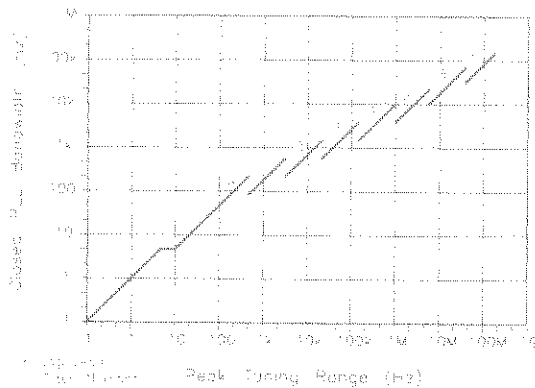

## 12 HP 3048A Noise Floor Limits Due to Peak Tuning Range

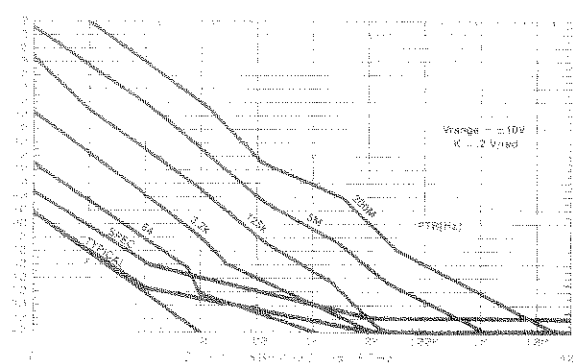

# Quick Reference

---

# 7

<b>1</b>	<b>Approximate HP 3048A Phase Noise Floor vs. R Port Signal Level</b>	pg. 7-2
<b>2</b>	<b>HP 3048A Phase Noise Floor and Region of Validity of <math>\mathcal{L}(f) = \frac{S_{\phi}(f)}{2}</math></b>	pg. 7-4
<b>3</b>	<b>Phase Noise Level of Various HP Sources</b>	pg. 7-6
<b>4</b>	<b>Increase in Measured Noise as Reference Source Noise Approaches DUT Noise</b>	pg. 7-8
<b>5</b>	<b>Approximate Sensitivity of Delay Line Discriminator</b>	pg. 7-10
<b>6</b>	<b>AM Calibration</b>	pg. 7-12
<b>7</b>	<b>Voltage Controlled Source Tuning Requirements</b>	pg. 7-14
<b>8</b>	<b>Voltage Tuning Range vs. Center Voltage</b>	pg. 7-16
<b>9</b>	<b>Tuning Characteristics of Various VCO Source Options</b>	pg. 7-18
<b>10</b>	<b>Peak Tuning Range Required Due to Noise Level</b>	pg. 7-22
<b>11</b>	<b>Phase Lock Loop Bandwidth vs. Peak Tuning Range</b>	pg. 7-24
<b>12</b>	<b>HP 3048A Noise Floor Limits Due to Peak Tuning Range</b>	pg. 7-28

# 1 Approximate HP 3048A Phase Noise Floor vs. R Port Signal Level

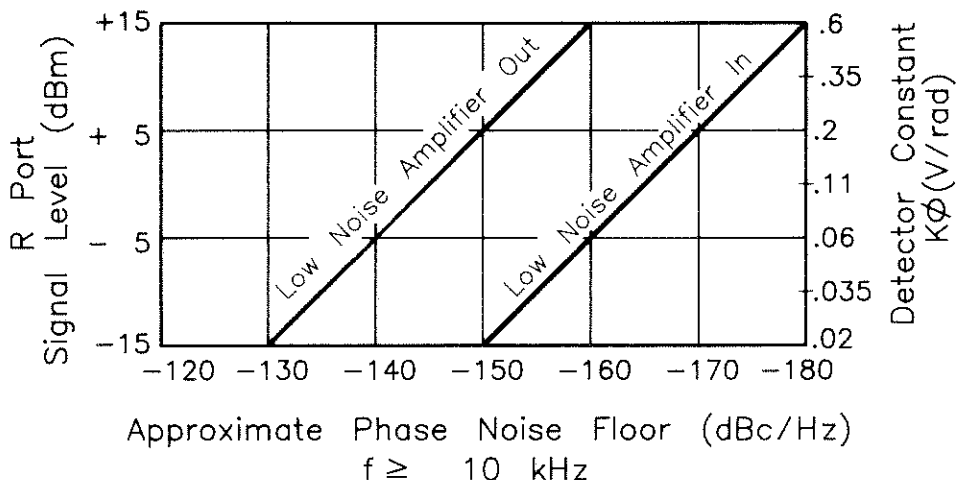

L Port Signal Level is Assumed to be Appropriate for the Phase Detector

## Description

The sensitivity of the HP 3048A System can be improved by increasing the signal power at the R input port of the Phase Detector in the HP 11848A. This graph illustrates the approximate noise floor of the system for a range of R input port signal levels from  $-15$  dBm to  $+15$  dBm. The diagonal line on the left side indicates the approximate sensitivity for offsets greater than 10 kHz without the system's low noise amplifier in the signal path. The right diagonal line indicates the sensitivity with the amplifier in. These estimates of sensitivity assume the signal level at the L port is appropriate for either the microwave or the RF mixer that is used ( $+7$  dBm or  $+15$  dBm, respectively). The approximate Phase Detector calibration Constant  $K_\phi$  that results from the input signal level at the R port is shown on the right side of the graph. (Refer to *Calibr Process* in Chapter 2, Measurement Definitions, for more information about calibration of the Phase Detector Constant.)





## 2 HP 3048A Phase Noise Floor and Region of Validity of $\mathcal{L}(f) = \frac{S_{\phi}(f)}{2}$

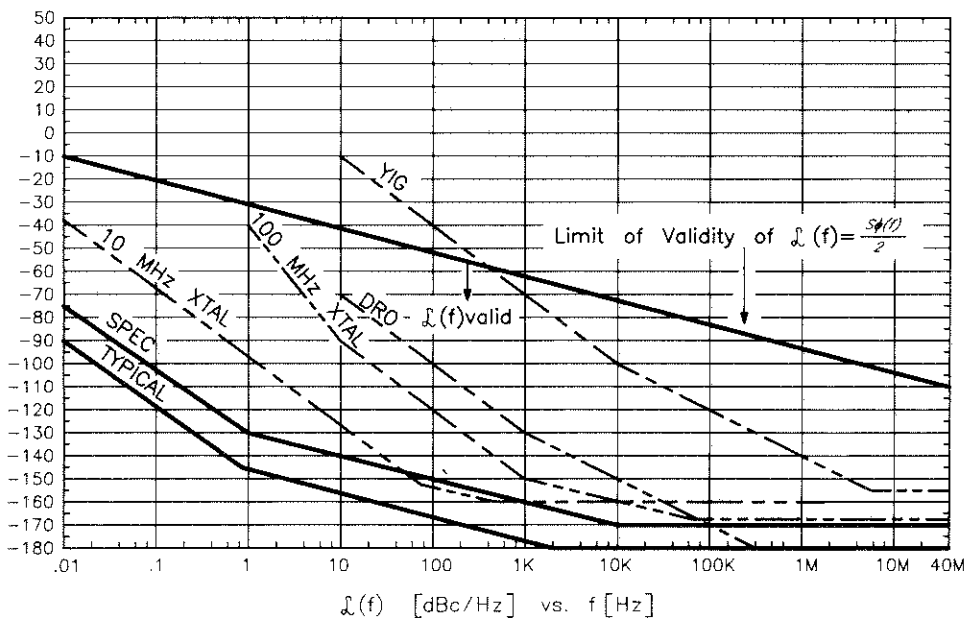

### Description

Caution must be exercised when  $\mathcal{L}(f)$  is calculated from the spectral density of the phase fluctuations,  $S_{\phi}(f)$ , because of the small angle criterion. The  $-10$  dB/decade line is drawn on the plot for an instantaneous phase deviation of  $0.2$  radians integrated over any one decade of offset frequency. At approximately  $0.2$  radians the power in the higher order sidebands of the phase modulation is still insignificant compared to the power in the first order sideband which ensures the calculation of  $\mathcal{L}(f)$  is still valid. Below the line the plot of  $\mathcal{L}(f)$  is correct; above the line  $\mathcal{L}(f)$  is increasingly invalid and  $S_{\phi}(f)$  must be used to represent the phase noise of the signal. ( $S_{\phi}(f)$  is valid both above and below the line.) When using the  $\mathcal{L}(f)$  graph to compute  $S_{\phi}(f)$ , add  $3$  dB to the offset Level.

$$S_{\phi}(f) = 2(\mathcal{L}(f))$$

# EXAMPLE

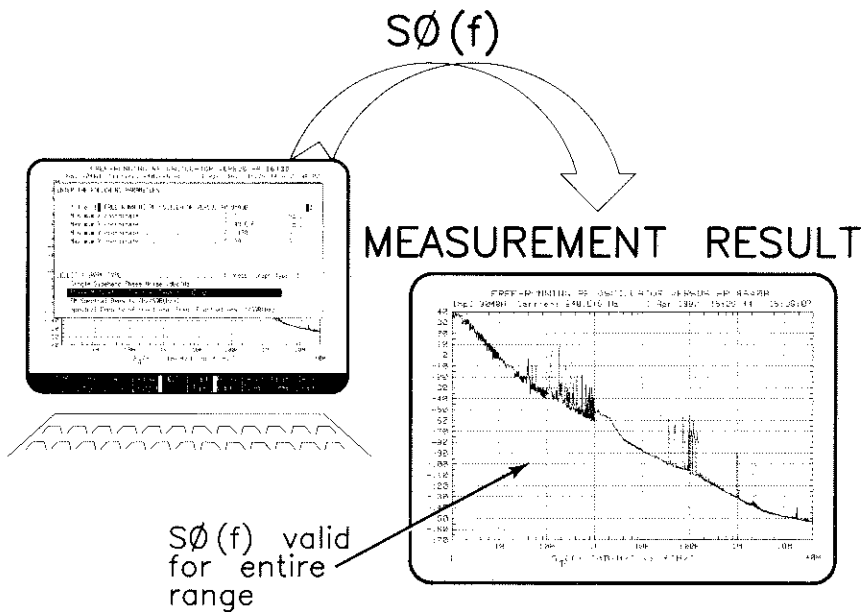
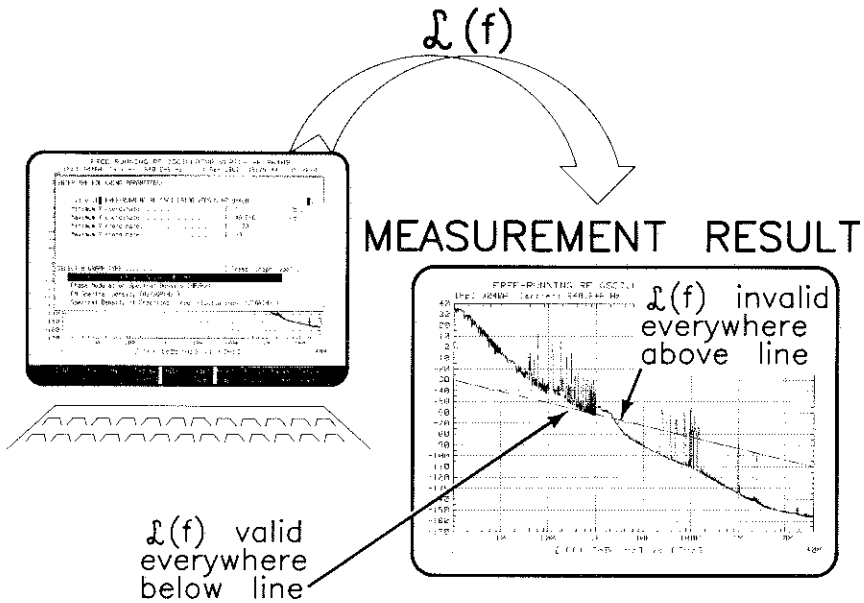

### 3 Phase Noise Level of Various HP Sources

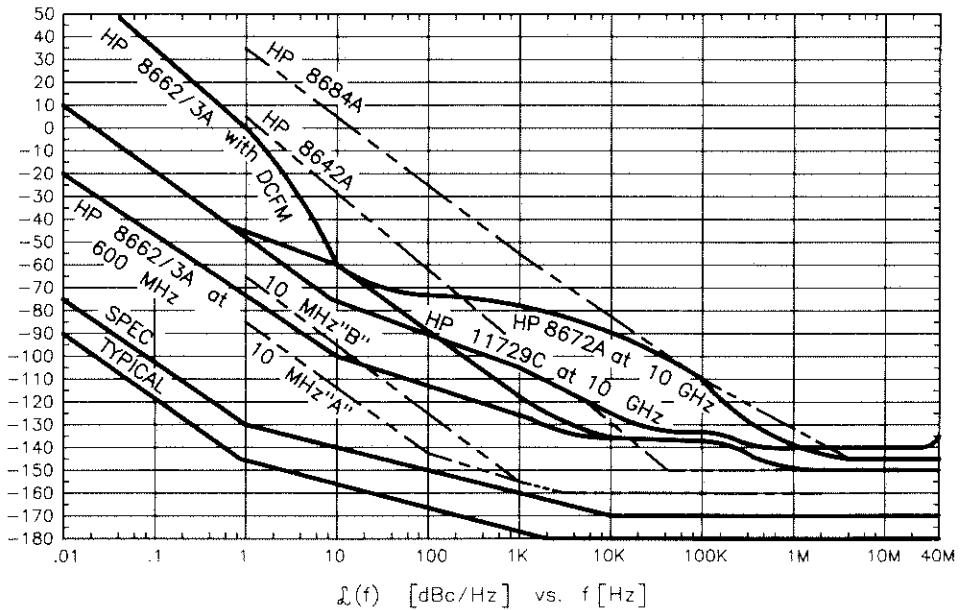

### Description

This graph indicates the level of phase noise that has been measured for several potential reference sources. Depending on the sensitivity that is required at the offset to be measured, a single reference source may suffice or several different references may be needed to achieve the necessary sensitivity at different offsets. (Refer to *RF Sources* in Chapter 6, System Configuration, for complete specifications of the HP 3048A supported sources.)

# EXAMPLE

HP 8662A Used      HP 8642A Used  
1 to 8 kHz      8 kHz to 40 MHz

HP 8642A  
DUT Level  
HP 8662A

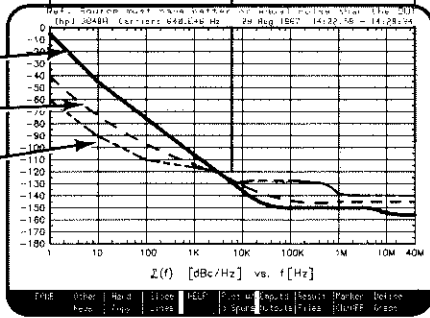

## MEASUREMENT RESULT

## 4 Increase in Measured Noise as Reference Source Noise Approaches DUT Noise

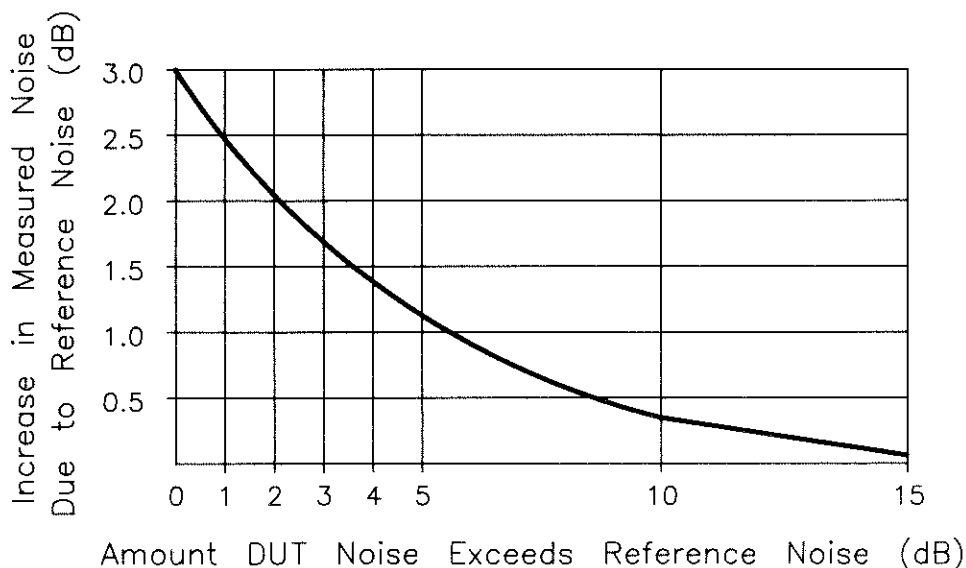

### Description

This graph demonstrates that as the noise level of the reference source approaches the noise level of the DUT, the level measured by the HP 3048A (which is the sum of all sources affecting the system) is increased above the actual noise level of the DUT. (Refer to *Selecting a Reference* in Chapter 3, Signal Source Applications of the HP 3048A Operating Manual for further information about the noise contribution of sources.)

# EXAMPLE

## MEASUREMENT RESULT

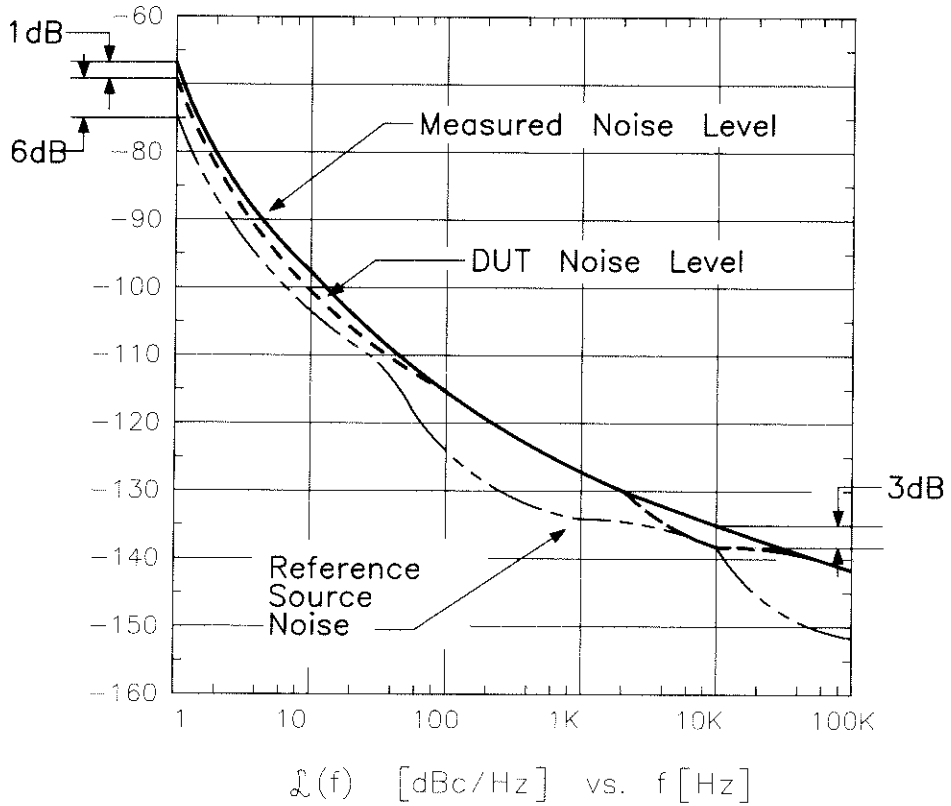

## 5 Approximate Sensitivity of Delay Line Discriminator

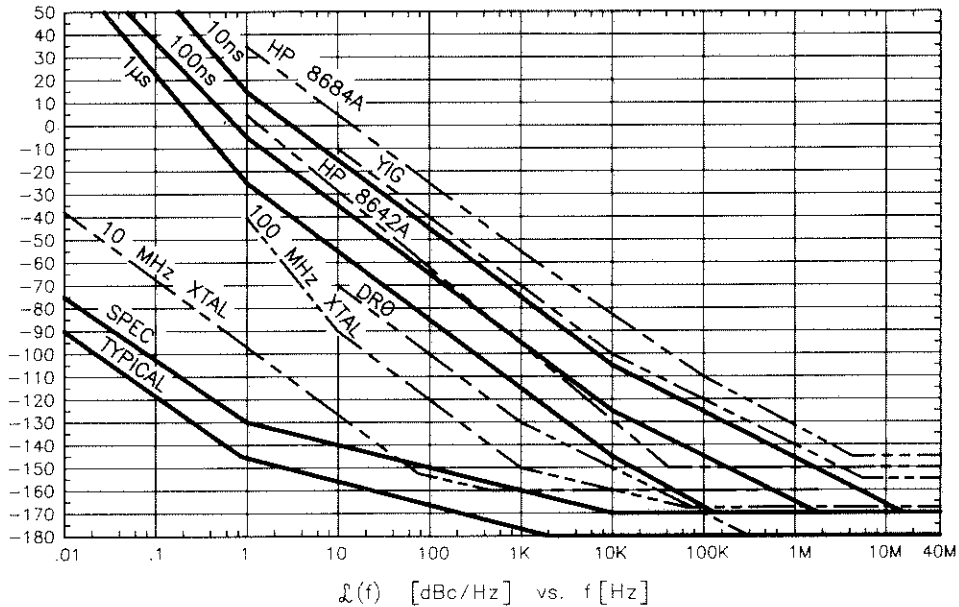

### Description

The dependence of a frequency discriminator's sensitivity on the offset frequency is obvious from this graph. By comparing the sensitivity specified for the phase detector of the HP 3048A to the delay line sensitivity, it is apparent the delay line sensitivity is "tipped up" by 20 dB/decade beginning at an offset of  $\frac{1}{2\pi\tau}$ . The sensitivity graphs indicate the delay line frequency discriminator can be used to measure some types of sources with useful sensitivity. Longer delay lines will improve the sensitivity, but eventually the loss in the delay line will exceed the available power of the source and cancel any further improvement. Also, longer delay lines limit the maximum offset frequency that can be measured. (Refer to *Calibr Process* in Chapter 2, Measurement Definitions, for delay line restrictions.)



# EXAMPLE

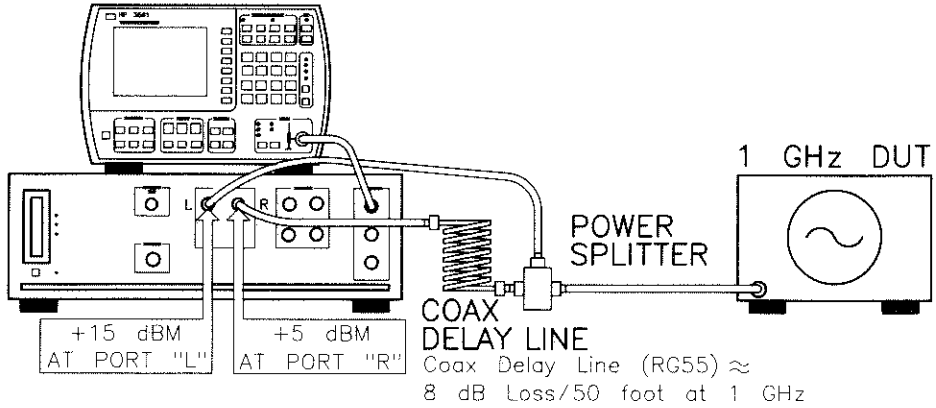

## MEASUREMENT RESULT USING AN FM DISCRIMINATOR

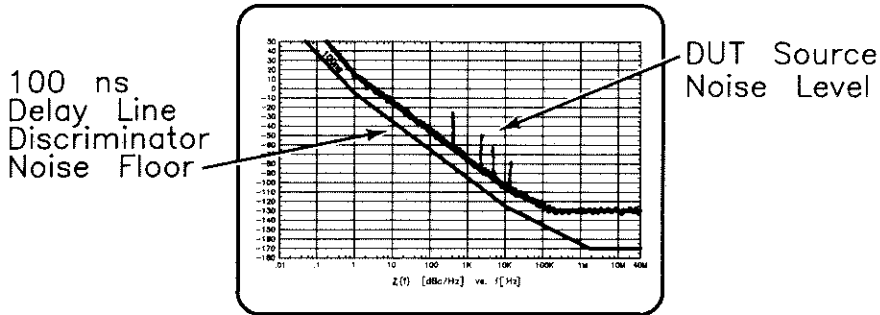

## 6 AM Calibration

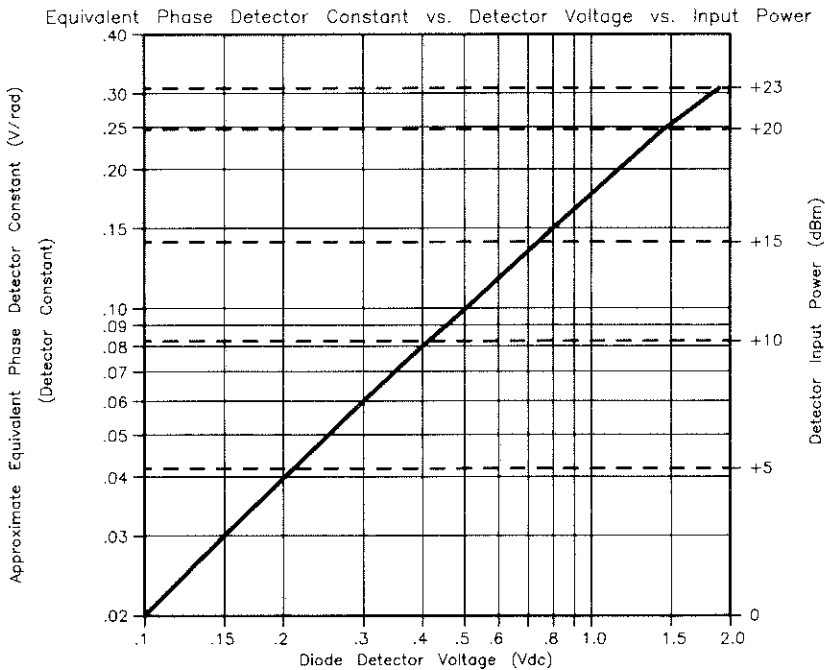

### Description

The AM detector sensitivity graph can be used to determine the equivalent Phase Detector Constant from the measured AM Detector input level or from the diode detector's dc voltage. The equivalent Phase Detector Constant (phase slope) is read from the left side of the graph while the approximate detector input power can be read from the right side of the graph. (Refer to *Calibr Process* in Chapter 2, Measurement Definitions, for information about determining the AM Detector constant.)

# EXAMPLE

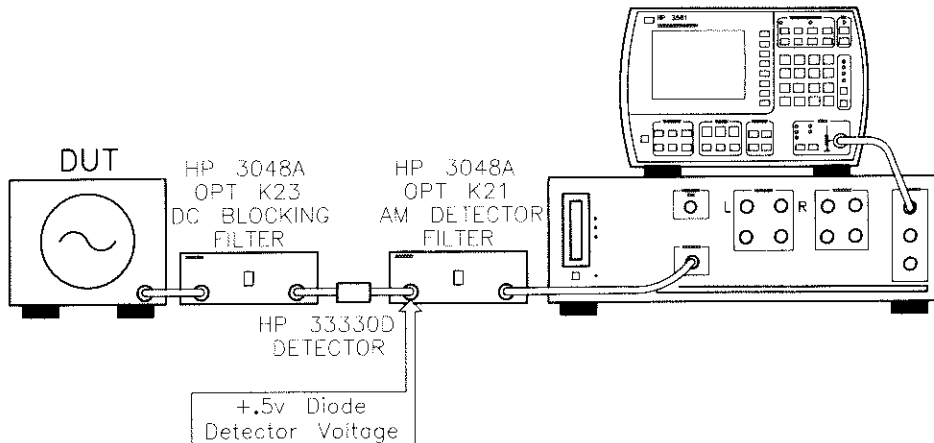

## MEASUREMENT RESULT

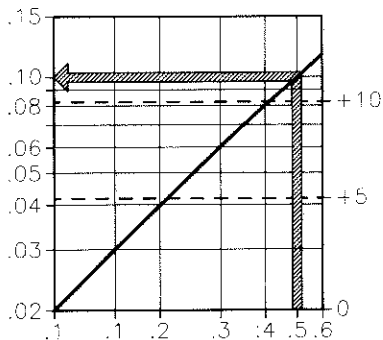
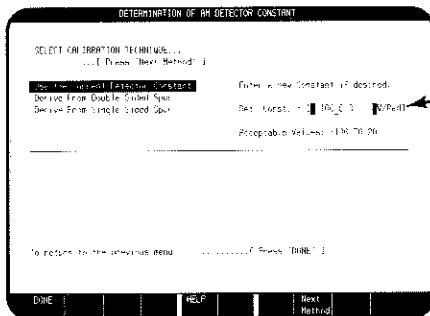

## 7 Voltage Controlled Source Tuning Requirements

Peak Tuning Range (PTR)  $\approx$  Voltage Tuning Range  
X VCO Tuning Constant

Min. PTR = .1 Hz

Max. PTR = 500 kHz (200 MHz with  
an RF Analyzer).

Drift Tracking Range = Allowable Drift During  
Measurement.

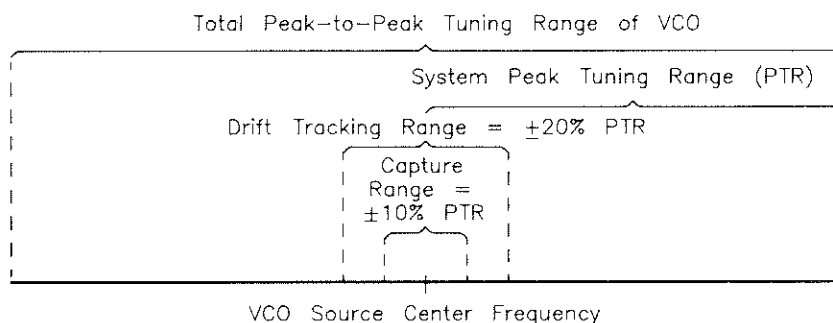

### Description

The tuning range that the HP 3048A actually uses to maintain quadrature is limited to a fraction of the peak tuning range (PTR) to ensure the tuning slope is well behaved and the VCO Tuning Constant remains accurate. After phase lock is established, the system monitors the tuning voltage required to maintain lock during calibration. If the tuning voltage exceeds 10% of the peak tuning range during system calibration, the HP 3048A stops the procedure and informs the user that the source needs to be retuned before the measurement can begin. If the tuning voltage exceeds 20% of the PTR during the measurement, the system again informs the user and requests the oscillator be retuned or the problem be otherwise corrected before proceeding with the measurement. These limits have been found to guarantee good results even for sources with very wide or complex tuning voltages. (Refer to the PLL Measurement sections of *Calibr Process* and *Instr. Params* in Chapter 2, Measurement Definitions, for a description of the system's requirements when making a PLL measurement.)

# EXAMPLE

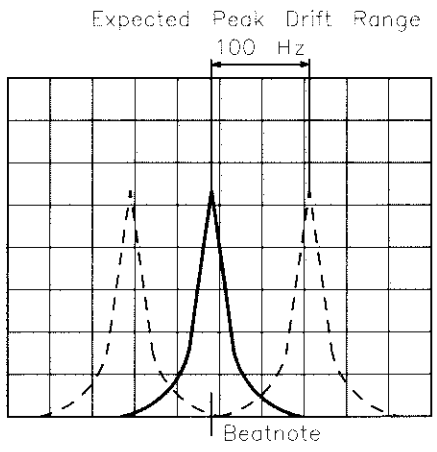
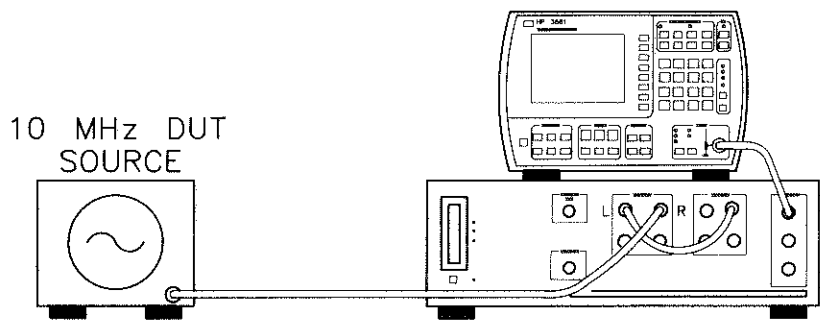

$$\begin{aligned} \text{Required Peak Tuning Range(PTR)} &= \text{Peak Drift} \times 10 \\ &= 100 \text{ Hz} \times 10 \\ &= 1 \text{ kHz} \end{aligned}$$

# MEASUREMENT RESULT

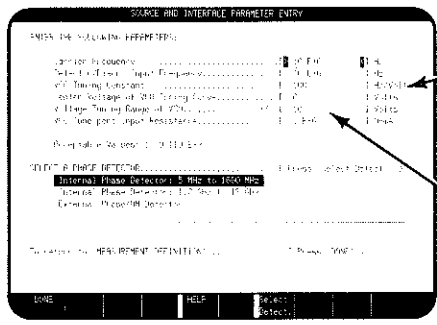

10 MHz B  
Tuning Constant

$$\begin{aligned} \text{Required Voltage Tune Range} &= \text{PTR/TC} \\ &= 1 \text{ kHz} / 100 \text{ Hz} \\ &= 10\text{V} \end{aligned}$$

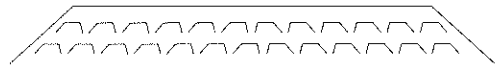

## 8 Voltage Tuning Range vs. Center Voltage

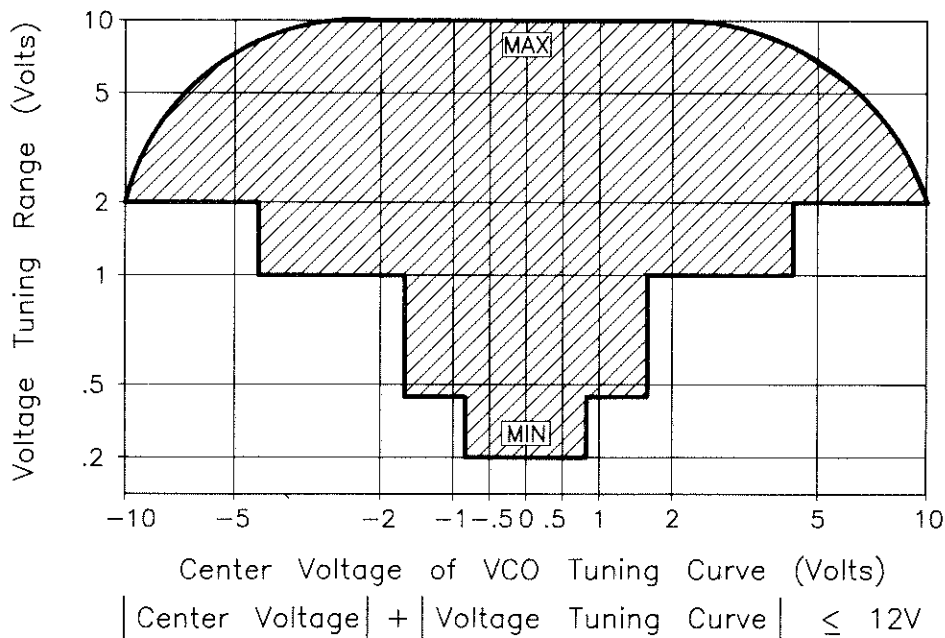

### Description

This graph outlines the minimum to maximum voltage tuning range the HP 3048A can provide for a given center voltage. The tuning voltage range decreases as the absolute value of the center voltage increases due to hardware limitations of the system. (Refer to *Instr. Params* in Chapter 2, Measurement Definitions, for further information about the Voltage Tuning Range.)

# EXAMPLE

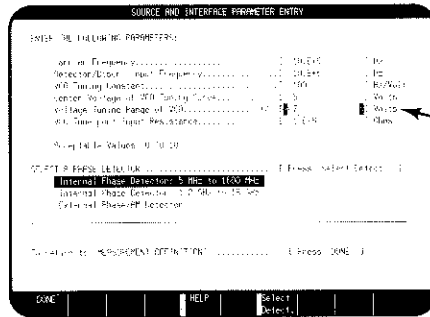
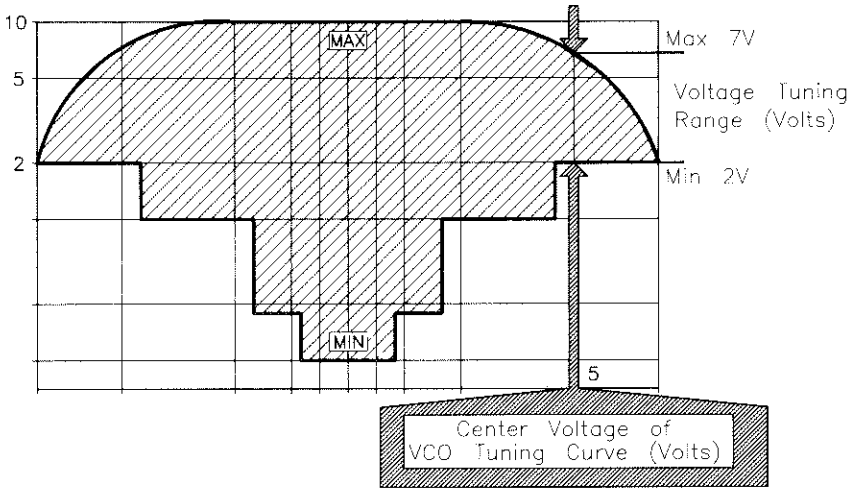

Acceptable Entry  
2V to 7V



## 9 Tuning Characteristics of Various VCO Source Options

VCO Source	Carrier Freq.	Tuning Constant (Hz/V)	Center Voltage (V)	Voltage Tuning Range ( $\pm V$ )	Input Resistance (ohms)	Tuning Calibration Method																																																																																
HP 8662/3A EFC DCFM	$\nu_o$	5 E - 9 $\times \nu_o$	0	10	1 E + 6 1k (8662) 600 (8663)	Measure Compute Compute																																																																																
		FM Deviation	0	10			HP 8642A/B		FM Deviation	0	10	600	Compute	HP 8640B		FM Deviation	0	10	600	Compute	HP 8656B		FM Deviation	0	10	600	Compute	Other Signal Generator DCFM Calibrated for $\pm 1V$		FM Deviation	0	10	$R_{in}$	Compute	10 MHz Source A Direct Multiplied As a Timebase: To HP 8662/3A To other synthesized signal generators	$\nu_o$	10	0	10	1 E + 6	Measure	1 E - 6 $\times \nu_o$	0	10	1 E + 6	$\nu_o$	1 E - 6 $\times \nu_o$	0	10 E + 9 $\div \nu_o$	1 E + 6	$\nu_o$	1 E - 6 $\times \nu_o$	0	1 E + 6 $\times PTR^* \div \nu_o$	1 E + 6	10 MHz Source B Direct Multiplied As a Timebase: To HP 8662/3A  To other synthesized signal generators	$\nu_o$	100	0	10	1 E + 6	Measure	10 E - 6 $\times \nu_o$	0	10	1 E + 6	$\nu_o$	10 E - 6 $\times \nu_o$	0	1 E + 9 $\div \nu_o$ , (up to 2.5V max.)	1 E + 6	$\nu_o$	10 E - 6 $\times \nu_o$		100 E + 3 $\times PTR^* \div \nu_o$	1 E + 6	350-500 MHz Source		12 E + 6	0	2	1 E + 6	Measure	Other User VCO Source		Estimated within a factor of 2
HP 8642A/B		FM Deviation	0	10	600	Compute																																																																																
HP 8640B		FM Deviation	0	10	600	Compute																																																																																
HP 8656B		FM Deviation	0	10	600	Compute																																																																																
Other Signal Generator DCFM Calibrated for $\pm 1V$		FM Deviation	0	10	$R_{in}$	Compute																																																																																
10 MHz Source A Direct Multiplied As a Timebase: To HP 8662/3A To other synthesized signal generators	$\nu_o$	10	0	10	1 E + 6	Measure																																																																																
		1 E - 6 $\times \nu_o$	0	10	1 E + 6																																																																																	
	$\nu_o$	1 E - 6 $\times \nu_o$	0	10 E + 9 $\div \nu_o$	1 E + 6																																																																																	
	$\nu_o$	1 E - 6 $\times \nu_o$	0	1 E + 6 $\times PTR^* \div \nu_o$	1 E + 6																																																																																	
10 MHz Source B Direct Multiplied As a Timebase: To HP 8662/3A  To other synthesized signal generators	$\nu_o$	100	0	10	1 E + 6	Measure																																																																																
		10 E - 6 $\times \nu_o$	0	10	1 E + 6																																																																																	
	$\nu_o$	10 E - 6 $\times \nu_o$	0	1 E + 9 $\div \nu_o$ , (up to 2.5V max.)	1 E + 6																																																																																	
	$\nu_o$	10 E - 6 $\times \nu_o$		100 E + 3 $\times PTR^* \div \nu_o$	1 E + 6																																																																																	
350-500 MHz Source		12 E + 6	0	2	1 E + 6	Measure																																																																																
Other User VCO Source		Estimated within a factor of 2	-10 to +10	See Graph 8	1 E + 6	Measure																																																																																

\* Limited PTR due to PLL BW limitations.

## Description

This table lists the tuning parameters for several VCO source options. (Refer to *Instr. Params* in Chapter 2, Measurement Definitions, for further information on tuning sources.)



# EXAMPLE A

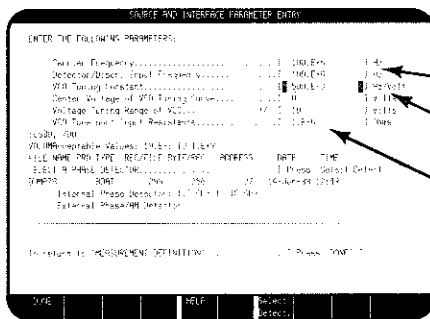
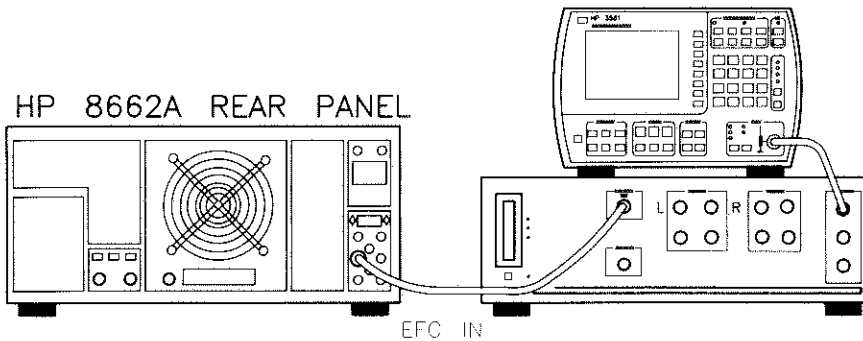

$V_o = 100 \text{ MHz}$

$5E - 9 \times 100 \text{ E6} = 1.5$

Tune Port Resistance

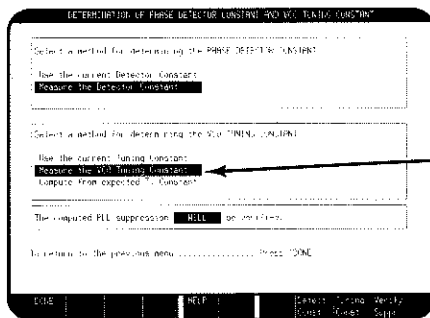
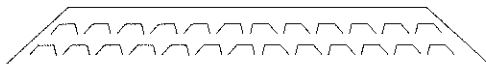

Refer To Chapter 2 Calibration Process For Details On Determining the VCO Tuning Constant

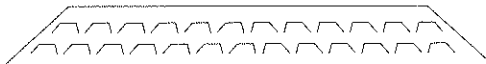

## 9 Tuning Characteristics of Various VCO Source Options

VCO Source	Carrier Freq.	Tuning Constant (Hz/V)	Center Voltage (V)	Voltage Tuning Range ( $\pm V$ )	Input Resistance (ohms)	Tuning Calibration Method
<b>HP 8662/3A</b> EFC DCFM	$v_o$	$5 E - 9 \times v_o$ FM Deviation	0 0	10 10	$1 E + 6$ 1k (8662) 600 (8663)	Measure Compute Compute
<b>HP 8642A/B</b>		FM Deviation	0	10	600	Compute
<b>HP 8640B</b>		FM Deviation	0	10	600	Compute
<b>HP 8656B</b>		FM Deviation	0	10	600	Compute
<b>Other Signal Generator</b> DCFM Calibrated for $\pm 1V$		FM Deviation	0	10	$R_{in}$	Compute
<b>10 MHz Source A</b> Direct Multiplied As a Timebase: To HP 8662/3A To other synthesized signal generators	$v_o$  $v_o$ $v_o$	10 $1 E - 6 \times v_o$ $1 E - 6 \times v_o$ $1 E - 6 \times v_o$	0 0 0 0	10 10 $10 E + 9 \div v_o$ $1 E + 6 \times PTR^* \div v_o$	$1 E + 6$ $1 E + 6$ $1 E + 6$ $1 E + 6$	Measure
<b>10 MHz Source B</b> Direct Multiplied As a Timebase: To HP 8662/3A To other synthesized signal generators	$v_o$  $v_o$ $v_o$	100 $10 E - 6 \times v_o$ $10 E - 6 \times v_o$ $10 E - 6 \times v_o$	0 0 0 0	10 10 $1 E + 9 \div v_o$ , (up to 2.5V max.) $100 E + 3 \times PTR^* \div v_o$	$1 E + 6$ $1 E + 6$ $1 E + 6$ $1 E + 6$	Measure
<b>350-500 MHz Source</b>		$12 E + 6$	0	2	$1 E + 6$	Measure
<b>Other User VCO Source</b>		Estimated within a factor of 2	-10 to +10	See Graph 8	$1 E + 6$	Measure

\* Limited PTR due to PLL BW limitations.

## Description

This table lists the tuning parameters for several VCO source options. (Refer to *Instr. Params* in Chapter 2, Measurement Definitions, for further information on tuning sources.)



# 10 Peak Tuning Range Required Due to Noise Level

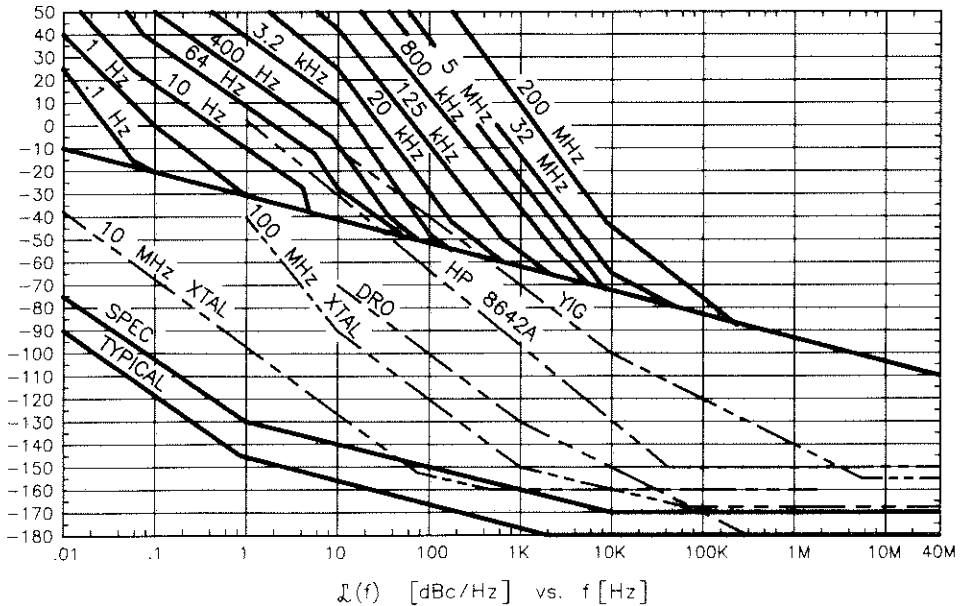

## Description

This graph provides a comparison between the typical phase noise level of a variety of sources and the minimum tuning range that is necessary for the system to create a phase lock loop of sufficient bandwidth to make the measurement. Typically, sources with higher phase noise require a wider Peak Tuning Range. These sources are usually designed with a wider tuning range in order to meet their application requirements. (Refer to the PLL section of *Instr. Params* in Chapter 2, *Measurement Definitions*, for further understanding of the Peak Tuning Range requirements.)

# EXAMPLE

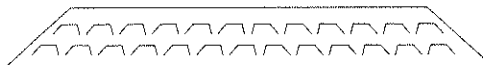
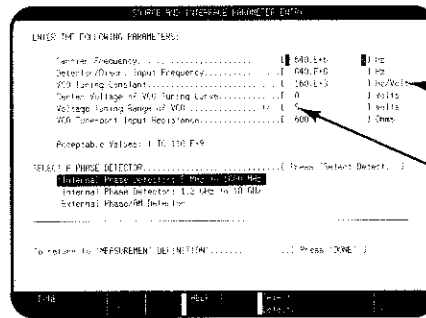
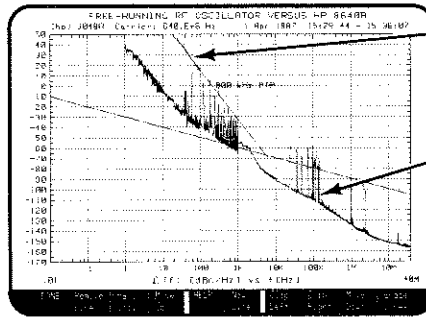

# 11 Phase Lock Loop Bandwidth vs. Peak Tuning Range

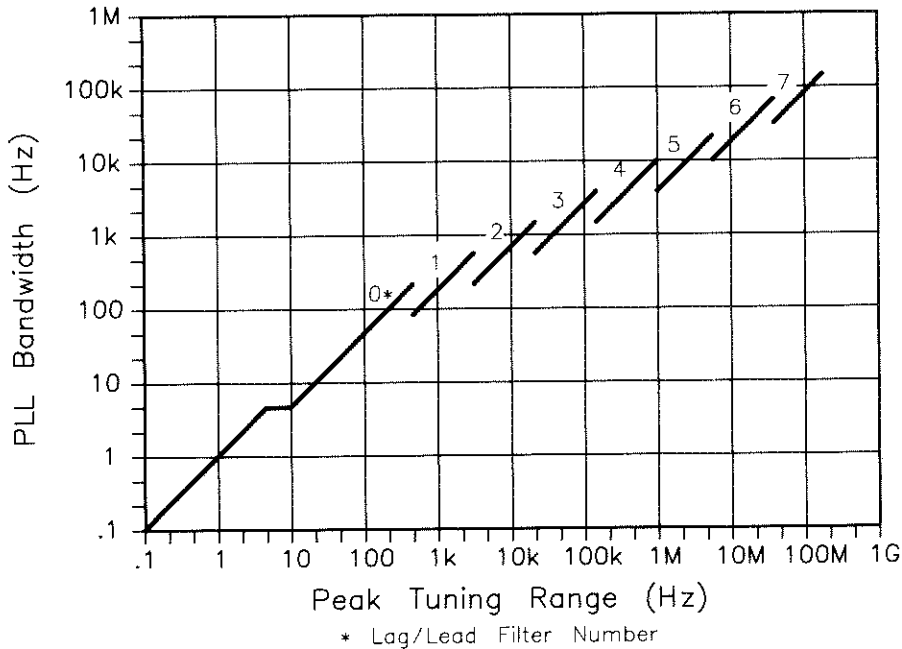

## Description

This graph illustrates the closed Phase Lock Loop Bandwidth (PLL BW) chosen by the system as a function of the Peak Tuning Range of the source. Knowing the approximate closed PLL BW allows you to verify that there is sufficient bandwidth on the tuning port and that sufficient source isolation is present to prevent injection locking. (Refer to *Instr. Params* in Chapter 2, Measurement Definitions, for a description of the Peak Tuning Range requirements.)

# EXAMPLE A OBSERVED INJECTION LOCKING

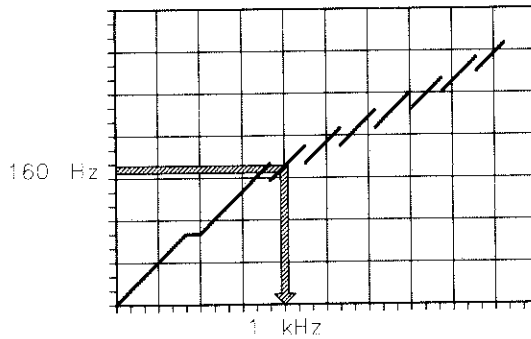
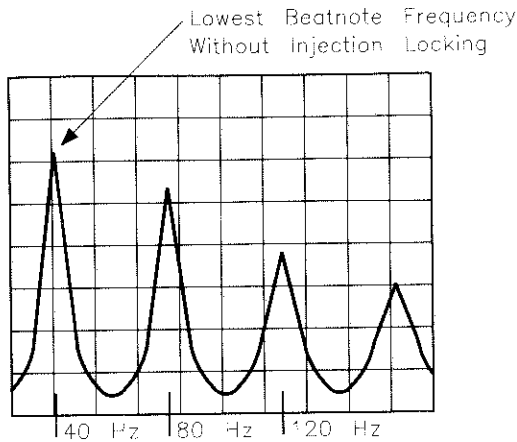

Required PTR For Observed injection Locking. PLLBW Must Be 4 X BW of Injection Locking

$$4 \times 40 = 160 \text{ Hz PLLBW}$$

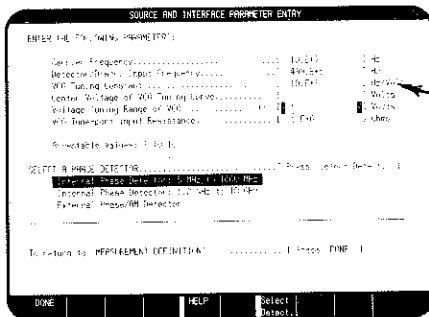

$$PTR = TV \times TC$$

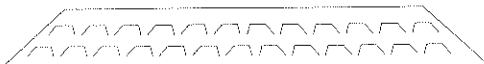

# 11 Phase Lock Loop Bandwidth vs. Peak Tuning Range

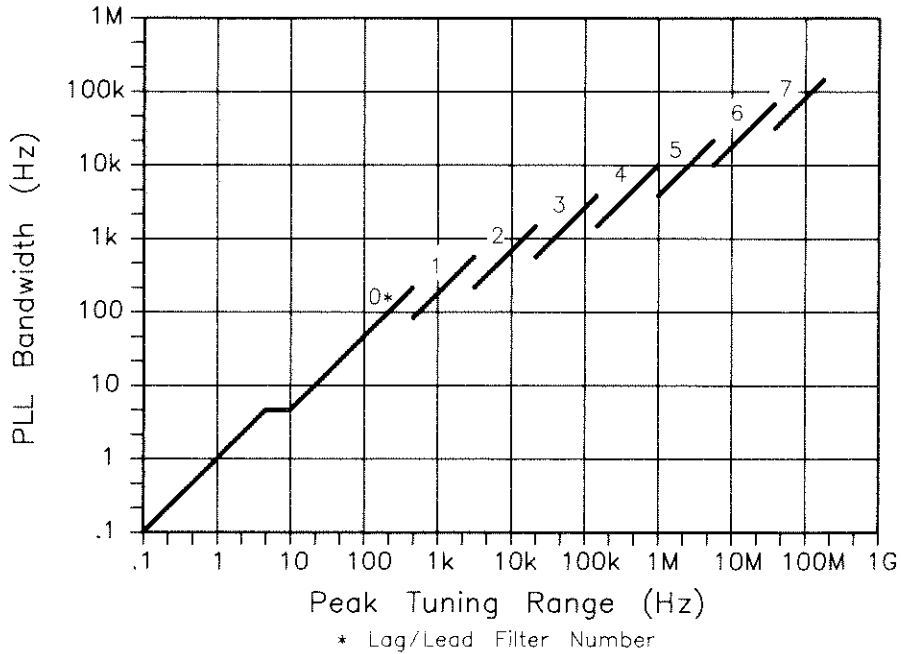

## Description

This graph illustrates the closed Phase Lock Loop Bandwidth (PLL BW) chosen by the system as a function of the Peak Tuning Range of the source. Knowing the approximate closed PLL BW allows you to verify that there is sufficient bandwidth on the tuning port and that sufficient source isolation is present to prevent injection locking. (Refer to *Instr. Params* in Chapter 2, Measurement Definitions, for a description of the Peak Tuning Range requirements.)



# EXAMPLE B

## FREQUENCY RESPONSE OF THE VCO TUNE PORT

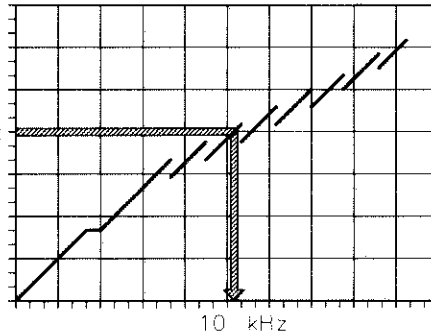
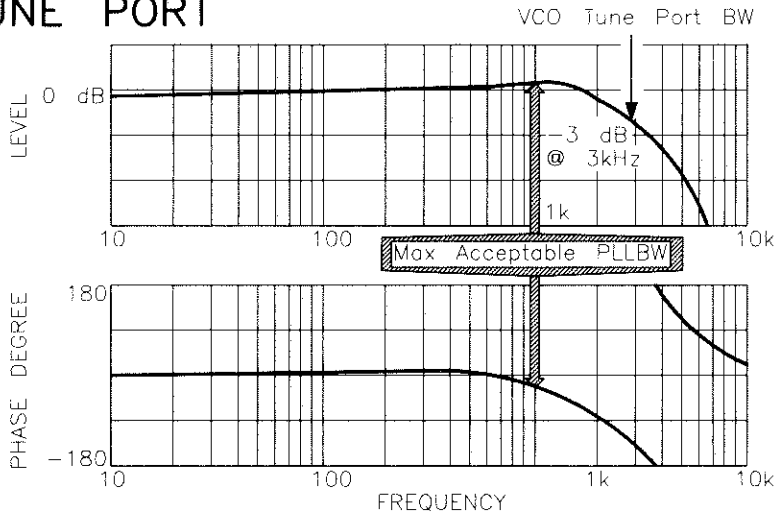

Max EFC BW For  
The HP 8662A  
is  $\approx$  3 kHz

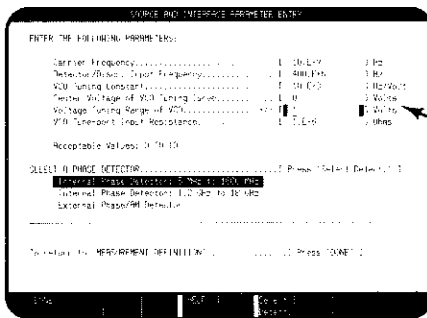

$TV \times TC = PTR$

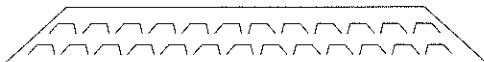

# 12 HP 3048A Noise Floor Limits Due to Peak Tuning Range

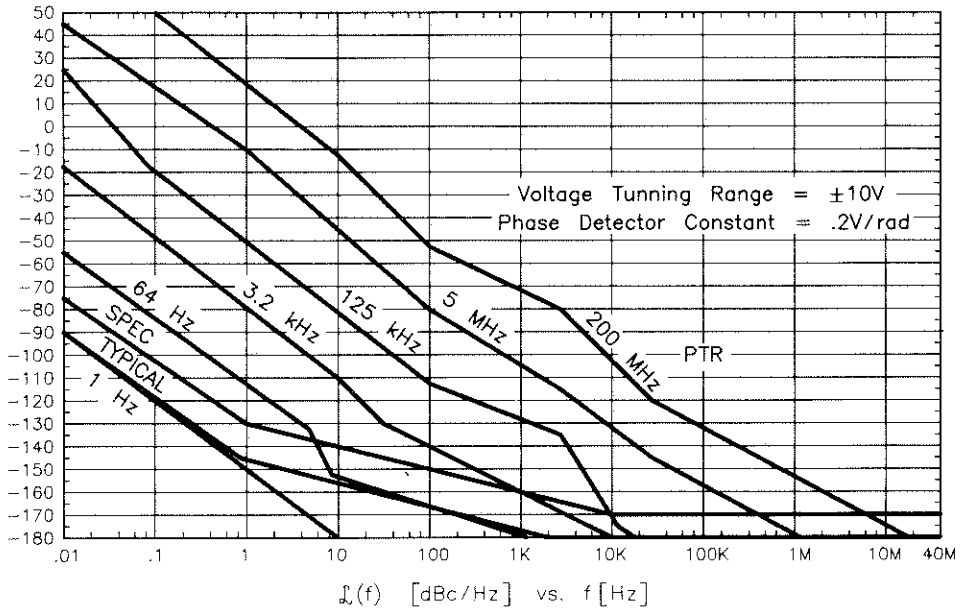

## Description

This graph shows the equivalent phase noise at the Peak Tuning Range entered for the source due to the inherent noise at the HP 11848A Tune Voltage Output port. (A Voltage Tuning Range of  $\pm 10V$  and Phase Detector Constant of  $0.2V/Rad$  is assumed.)

# EXAMPLE

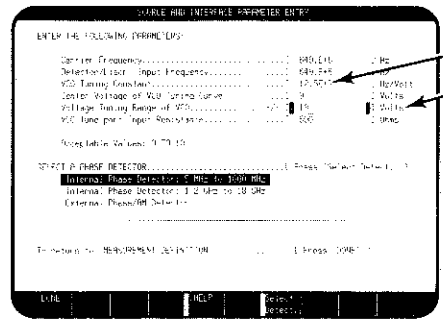

$TC \times TV = PTR$

$12.5 \text{ kHz/V} \times 10\text{V} = 125 \text{ kHz PTR}$

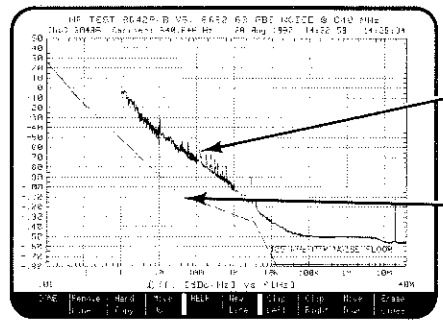

# Messages

---

# 8

## Introduction

The HP 3048A displays messages to aid you during the measurement process. These messages are grouped into four categories:

**Error:** Numbered Error Messages are listed in numerical order in Table 8-1 and Unnumbered Error Messages listed in alphabetical order in Table 8-2.

**Reference:** Reference Messages are listed in numerical order in Table 8-3.

**Warning:** Warning Messages are listed in alphabetical order in Table 8-4.

**Status:** Status Messages (prompts and updates) are listed in alphabetical order in Table 8-5.

<b>Numbered Error Messages</b> .....	pg. 8-2
<b>Unnumbered Error Messages</b> .....	pg. 8-19
<b>Reference Messages</b> .....	pg. 8-21
<b>Warning Messages</b> .....	pg. 8-28
<b>Status Messages</b> .....	pg. 8-29

Table 8-1. Numbered Error Messages (1 of 17)

<p><b>1</b></p>	<p><b>The Signal level entering the NOISE INPUT port of the HP 11848A exceeds 1 volt peak.</b></p> <p><b>Action:</b> Press the <b>Retry</b> key. If the overload condition was transient, the system will proceed with the measurement. If Error 1 occurs again, reduce the signal level at the NOISE INPUT port on the HP 11848A.</p> <p>If an HP 11729C is being used to make an AM measurement, insert a 20 dB (50 Ω) pad in the NOISE INPUT signal path. The pad should be connected directly to the HP 11848A.</p>
<p><b>2</b></p>	<p><b>The loop suppression peak exceeds 10 dB.</b> Excessive peaking can be caused by various conditions. Continuing with the measurement without verifying loop suppression may result in measurement accuracy degradation at offset frequencies within a decade of the PLL bandwidth.</p> <p style="text-align: center;"><b>NOTE</b></p> <p><i>The SOURCE OUT port on the rear-panel of the HP 3561A must be connected to the NOISE INPUT port on the rear panel of the HP 11848A. If these ports are not connected, connect them now, press the <b>Retry</b> softkey.</i></p> <p>Excessive loop suppression peaking is generally caused by one of three conditions. Each condition produces a somewhat different response of the loop suppression curve. The loop suppression curve is displayed on the HP 3561A after the system has completed the loop suppression characterization. Figure 8-1 illustrates the typical curve response for each of the three conditions.</p> <p><b>Action:</b> If the loop suppression peak for your measurement exceeds 10 dB (Error 2), observe the loop suppression curve displayed on your HP 3561A. Then refer to the following condition described for the curve in Figure 8-1 that most closely resembles the curve displayed on your HP 3561A.</p>

**Table 8-1. Numbered Error Messages (2 of 17)**

**2**  
(cont'd)

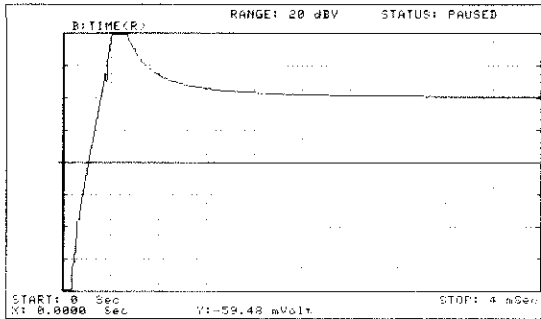

**1. Narrow Modulation Bandwidth**

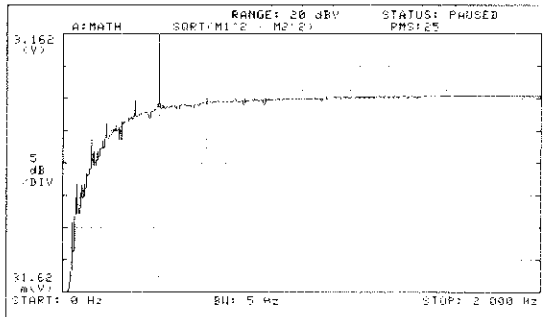

**2. Large Spur on Input Signal.**

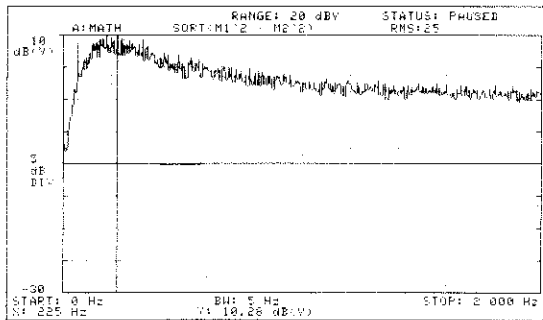

**3. High Noise on Input Signal**

**Figure 8-1. HP 3561A Display of Loop Suppression Curves.**

**Table 8-1. Numbered Error Messages (3 of 17)**

**2**

(cont'd)

**1. Narrow Modulation Bandwidth**

A noise hump on a relatively clean loop suppression curve occurs when the modulation bandwidth of the VCO's tune port is not wide enough to provide adequate phase margin for the system's phase lock loop (PLL). The VCO's modulation bandwidth (the upper frequency limit of the VCO's tuning port) should be greater than approximately ten times the PLL bandwidth set for the measurement. PLL bandwidth is shown as a function of the Peak Tuning Range (PTR) in Figure 8-2. (The PTR for the measurement is determined by multiplying the VCO's Tuning Constant by its Voltage Tuning Range.)

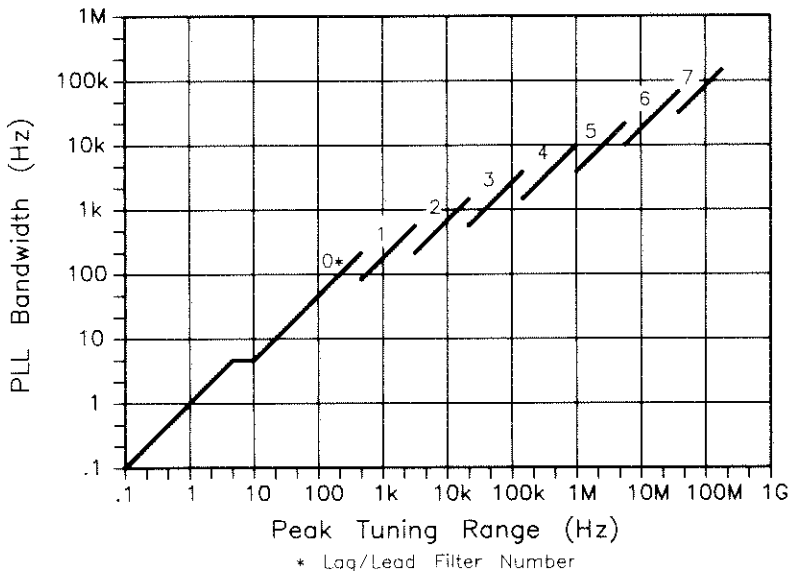

**Figure 8-2. Phase Lock Loop Bandwidth as a Function of the Peak Tuning Range of the Measurement.**

**Table 8-1. Numbered Error Messages (4 of 17)**

<p><b>2</b> (cont'd)</p>	<p>If the modulation bandwidth of the VCO source you are using is not at least 10 times greater than the PLL bandwidth for the measurement, there are generally three possible actions you can take.</p> <ul style="list-style-type: none"><li>● Increase the modulation bandwidth of the VCO source. If the VCO source is a bread-board or prototype oscillator, it may be possible to make the component changes necessary to provide sufficient modulation bandwidth.</li><li>● Use a different VCO source with greater modulation bandwidth.</li><li>● Decrease the PLL bandwidth to 1/10 the VCO's modulation bandwidth by decreasing the Peak Tuning Range (PTR) for the measurement. Use Figure 8-2 to determine the PTR required. The PTR can be reduced by decreasing the Tuning Voltage Range value entered. Divide the required PTR by the VCO's Tuning Constant to determine the appropriate Voltage Tuning Range to enter. (Keep in mind that reducing the PTR limits the HP 3048A's Frequency Drift Tracking Range for the measurement. For further information about changing the PTR, refer to <i>Changing the PTR</i> in Chapter 3 of the Operating Manual.) If you do not know the modulation bandwidth for your VCO source, you can determine it by locating the 3 dB roll-off frequency of the VCO tune port. The following steps describe a procedure for determining the modulation bandwidth.<ol style="list-style-type: none"><li>a. Connect a tracking generator output (such as the HP 3585A) to the tuning input port on your VCO.</li><li>b. Set the tracking generator output to sweep the audio spectrum.</li><li>c. Connect the RF output from your VCO to a modulation analyzer (such as an HP 8901A).</li><li>d. Set the modulation analyzer to measure FM.</li><li>e. Connect an audio spectrum analyzer to the MODULATION OUTPUT on the HP 8901A.</li><li>f. Increase the frequency spectrum of the tracking generator, if necessary, until the 3 dB roll-off frequency can be seen on the audio analyzer's display. The 3 dB frequency should be <math>\geq</math> ten times the PLL bandwidth for the measurement.</li></ol></li></ul> <p>The modulation bandwidth of a VCO can also be determined using the Bessel Null technique. Apply a series of audio frequencies to the tune port of the VCO. Observe the VCO's output signal on an RF Spectrum Analyzer and adjust the audio modulation level for the first carrier null. Calculate the VCO's modulation sensitivity at each modulation frequency using the level and frequency of the audio signal at the null setting. Plot the modulation sensitivity versus the audio frequency to determine the modulation bandwidth.</p>
------------------------------	---



Table 8-1. Numbered Error Messages (5 of 17)

<p><b>2</b> (cont'd)</p>	<p><b>2. Large Spur on Input Signal</b></p> <p>A sharp peak on an otherwise correct loop suppression curve is evidence of a large spur (typically &gt; -40 dBc) near the phase lock loop (PLL) bandwidth of the measurement (within a factor of two). Press <b>Proceed</b> to continue with the measurement. The measurement results may not be totally accurate but the noise graph will provide you with the offset frequency and approximate level of the spur. (Chapter 6 <i>Evaluating Measurement Results</i> in the HP 3048A Operating Manual, provides information that will help you isolate the spur source).</p> <p>If you are not able to reduce the spur level to &lt; -40 dBc, it may be possible to make an accurate noise measurement by changing the PLL bandwidth. Measurement accuracy is only affected by spurs &gt; -40 dBc that are within a factor of 2 of the PLL bandwidth.</p> <p>The PLL bandwidth is shown as a function of Peak Tuning Range (PTR) in Figure 8-2. (The PTR for the measurement is determined by multiplying the VCO's Tuning Constant by the VCO's Voltage Tuning Range entered for the measurement. For further information about changing the PTR, refer to <i>Changing the PTR</i> in Chapter 3 of the Operating Manual.</p> <p><b>3. High Noise on Input Signal</b></p> <p style="text-align: center;"><b>NOTE</b></p> <p style="text-align: center;"><i>Be sure that SOURCE OUT on the rear panel of the HP 3561A is connected to NOISE INPUT on the rear panel of the HP 11848A. If these ports are not connected, connect them now, press the <b>Retry</b> softkey.</i></p> <p>A noisy loop suppression curve is caused when one or both of the input signals has noise near the small angle line at offsets near the phase lock loop (PLL) bandwidth. For information about verifying the noise level and recommended actions for compensating for a high noise level, refer to <i>Evaluating Noise Above the Small Angle Line</i> in Chapter 3 of the Operating Manual.</p>
<p><b>3</b></p>	<p><b>Unable to detect the presence of a beatnote.</b></p> <p><b>Action:</b></p> <ol style="list-style-type: none"> <li>1. Check to be sure that the correct Phase Detector is selected in the Inst. Params menu.</li> <li>2. Check sources to verify the frequency of each output signal.</li> <li>3. Check for a beatnote. (A procedure for tuning the beatnote to within the Capture Range for the measurement is provided in the <i>Checking the Beatnote</i> section of each Phase Lock Loop measurement example in Chapter 3 of the Operating Manual. An oscilloscope connected to the HP 11848A AUX MONITOR port can be helpful for monitoring and zeroing the beatnote.)</li> <li>4. The sources must be within 50 kHz (20 MHz with an RF analyzer) of each other to allow the system to function correctly.</li> </ol>

Table 8-1. Numbered Error Messages (6 of 17)

<b>4</b>	<p data-bbox="249 236 731 263"><b>Unable to close the Phase Lock Loop.</b></p> <p data-bbox="249 343 1243 422"><b>Action:</b> There are several possible conditions that can prevent the HP 3048A from being able to close the phase lock loop. These conditions and the actions recommended for verifying them are listed below in the order of probable cause.</p> <ol data-bbox="266 464 1243 1396" style="list-style-type: none"><li data-bbox="266 464 1243 566">1. The system is not able to tune the beatnote to within the Capture Range set for the measurement. This possibility can be minimized by carefully following the <i>Checking the Beatnote</i> procedure provided in each measurement example in Chapter 3 of the Operating Manual. If an oscilloscope is available, you will find that connecting the scope to the AUX MONITOR port on the HP 11848A allows you to continuously monitor the beatnote throughout the measurement. By aborting this measurement and reinitiating a New Measurement, you can observe the beatnote as the HP 3048A attempts to close the phase lock loop (a message will appear in the HP 3048A's display to let you know when this is happening). The beatnote frequency, as seen on the scope, should decrease and then go to zero (dc). Watching the beatnote's response as the system attempts to adjust it to 0 Hz can provide clues about tuning problems that may exist.</li><li data-bbox="266 794 1243 869">2. The beatnote drifted beyond the system's Capture Range before the HP 3048A was able to acquire lock. For further information on verifying the frequency stability of the beatnote, refer to <i>Tracking Frequency Drift</i> in Chapter 3 of the Operating Manual.</li><li data-bbox="266 879 1243 1007">3. The VCO Tuning Constant entered for the measurement was not within a factor of 2 of the actual Tuning Constant, and the HP 3048A was not configured to <i>measure</i> the Tuning Constant for verification. For details on verifying the Tuning Constant of your VCO, refer to <i>Estimating the Tuning Constant</i> in Chapter 3 of the Operating Manual.</li><li data-bbox="266 1016 1243 1118">4. The Peak Tuning Range set for the measurement is &gt; 10 MHz and is causing the loop dynamics to be non-linear. When this condition exists, the non-linear response of the beatnote as the system attempts to close the phase lock loop can often be seen on an oscilloscope connected to the AUX MONITOR port on the HP 11848A.</li><li data-bbox="266 1128 1243 1203">5. One of the sources is being injection locked as the HP 3048A is tuning the beatnote to 0 Hz. (Refer to <i>Minimizing Injection Locking</i> in Chapter 3 of the Operating Manual for recommended actions.)</li><li data-bbox="266 1212 1243 1396">6. The modulation bandwidth of the VCO source's tuning port is not wide enough to provide adequate phase margin for the system's phase lock loop (PLL). The VCO's modulation bandwidth (the upper frequency limit of the VCO's tuning port) should be greater than approximately ten times the PLL bandwidth set for the measurement. PLL bandwidth is shown as a function of the Peak Tuning Range (PTR) in Figure 8-3. (The PTR for the measurement is determined by multiplying the VCO's Tuning Constant by its Voltage Tuning Range.)</li></ol>
----------	--

Table 8-1. Numbered Error Messages (7 of 17)

**4**  
(cont'd)

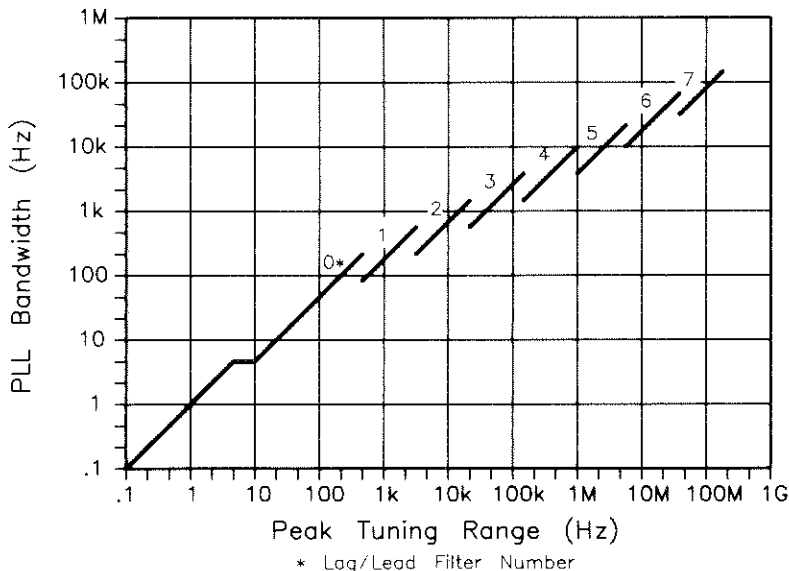

**Figure 8-3. Phase Lock Loop Bandwidth as a Function of the Peak Tuning Range of the Measurement.**

If the modulation bandwidth of the VCO source you are using is not at least 10 times greater than the PLL bandwidth for the measurement, there are generally three possible actions you can take.

- Increase the modulation bandwidth of the VCO source. If the VCO source is a breadboard or prototype oscillator, it may be possible to make the component changes necessary to provide sufficient modulation bandwidth.
- Use a different VCO source with greater modulation bandwidth.
- Decrease the PLL bandwidth to 1/10 the VCO's modulation bandwidth by decreasing the Peak Tuning Range (PTR) for the measurement. Use Figure 8-3 to determine the PTR required. The PTR can be reduced by decreasing the Tuning Voltage Range value entered. Divide the required PTR by the VCO's Tuning Constant to determine the appropriate Voltage Tuning Range to enter. (Keep in mind that reducing the PTR limits the HP 3048A's Frequency Drift Tracking Range for the measurement. For further information about changing the PTR, refer to *Changing the PTR* in Chapter 3 of the Operating Manual.)

**Table 8-1. Numbered Error Messages (8 of 17)**

<p><b>4</b> (cont'd)</p>	<p>If you do not know the modulation bandwidth for your VCO source, you can determine it by locating the 3 dB roll-off frequency of the VCO tune port. The following steps describe a procedure for determining the modulation bandwidth.</p> <ol style="list-style-type: none"> <li>a. Connect a tracking generator output (such as the HP 3585A) to the tuning input port on your VCO.</li> <li>b. Set the tracking generator output to sweep the audio spectrum.</li> <li>c. Connect the RF output from your VCO to a modulation analyzer (such as an HP 8901A).</li> <li>d. Set the modulation analyzer to measure FM.</li> <li>e. Connect an audio spectrum analyzer to the MODULATION OUTPUT on the HP 8901A.</li> <li>f. Increase the frequency spectrum of the tracking generator, if necessary, until the 3 dB roll-off frequency can be seen on the audio analyzer's display. The 3 dB frequency should be <math>\geq</math> ten times the PLL bandwidth for the measurement.</li> </ol> <p>The modulation bandwidth of a VCO can also be determined using the Bessel Null technique. Apply a series of audio frequencies to the tune port of the VCO. Observe on an RF Spectrum Analyzer and adjust the audio modulation level for the first carrier null. Calculate the VCO's modulation sensitivity at each audio frequency using the level and frequency of the audio signal at the null setting.</p> <ol style="list-style-type: none"> <li>7. The noise on one or both sources exceeds the small angle limit. For information about verifying the noise level and recommended action, refer to <i>Evaluating Noise Above the Small Angle Line</i> in Chapter 3 of the Operating Manual. For information about measuring sources with high close-in noise, refer to Ignore Out of Lock in the Test Mode Section of Chapter 5 of this manual.</li> </ol>
<p><b>5</b></p>	<p><b>Measured VCO peak tuning range exceeds 500 kHz (or 200 MHz.)</b> The Peak Tuning Range limit for the system is 500 kHz (or 200 MHz if an RF analyzer is configured in the system). The Peak Tuning Range is the product of the VCO Tuning Constant multiplied by the Voltage Tuning Range of the VCO. (If the system <i>measures</i> the VCO's Tuning Constant, it will use the measured value to compute the Peak Tuning Range for the measurement.)</p> <p><b>Action:</b> Reduce the Voltage Tuning Range entered for the VCO source you are using, or select a VCO source with a lower Tuning Constant.</p>
<p><b>6</b></p>	<p><b>Unable to establish quadrature.</b> Occurs when source is under system control and system is unable to acquire quadrature. The system attempts to acquire quadrature at the beginning of the measurement and after it has completed a measurement segment if quadrature was lost at any time while the segment was being measured.</p> <p><b>Action:</b> Manually adjust for quadrature by adjusting the source frequency (or the Phase Shifter if one is being used). Adjust for center scale on the HP 11848A Quadrature Meter.</p>

Table 8-1. Numbered Error Messages (9 of 17)

7

**Measured beatnotes depict non-linear VCO Tuning Constant.** (Error 7 only occurs when the HP 3048A has been configured to *Measure the VCO Tuning Constant*.)

The values shown on the display represent the measured beatnote frequencies for four tune voltage settings. The tune voltage settings are each derived as a percentage of the entered Voltage Tuning Range of the VCO (-45%, -15%, +15%, +45%) relative to the entered Center Voltage of the VCO Tuning Curve. For Example:

Voltage Tuning Range of VCO =  $\pm 10V$   
Center Voltage of VCO Tuning Curve =  $0V$   
Tune Voltage Settings =  $-4.5V, -1.5V, +1.5V, +4.5V$ .

Refer to *Instrument Parameters* in Chapter 2, Measurement Definitions for system requirements for VCO linearity.

Note that between the four measured frequency values shown on the display, three frequency range intervals are created. (For example, the measured values 95 Hz, 98.2 Hz, 101.2 Hz, 105 Hz produce the following intervals: Interval 1 = 3.2 Hz, Interval 2 = 3 Hz and Interval 3 = 3.8 Hz.)

**Action:**

1. This error will occur if a Tuning Voltage Range of  $\pm 10$  volts has been defined for a source with calibrated DC FM, and the HP 3048A is configured to *Measure* the VCO Tuning Constant rather than to *Compute* it. Refer to "Enhanced Tuning" in the *Instrument Parameters* section of Chapter 2, Measurement Definitions for details on extending the Tuning Voltage Range of calibrated DC FM.
2. If Interval 2 (described above)  $\gg 1$ , and Interval 2  $\gg 3$ , then:  
Reduce the value entered for the Voltage Tuning Range of the VCO and then initiate a New Measurement.
3. If there appears to be too little or no change between the measured frequency values (Intervals 1, 2, and 3  $\approx 0$ ) then :
  - Check the Tune Voltage cable connections.
  - Verify that the VCO's tuning is enabled.
  - Perform the *Estimating the Tuning Constant* procedure provided in Chapter 3 of the Operating Manual to verify the tuning response of the VCO and check that the entered VCO Tuning Constant is within a factor of 2 of the actual value.
  - Refer to *Instrument Parameters* in Chapter 2, Measurement Definitions for Tuning Constant linearity requirements.
  - Verify that the beatnote is tuned to within the Capture Range for the measurement.

**Table 8-1. Numbered Error Messages (10 of 17)**

<p><b>7</b> (cont'd)</p>	<p>4. If the Frequency Intervals vary greatly and are considerably larger than expected for the tuning range of the the VCO, then:</p> <ul style="list-style-type: none"> <li>• Check for erratic frequency drift of the beatnote. (Beatnote stability is directly related to the frequency stability of each signal source used in the measurement.)</li> </ul> <p>5. If all four measured frequencies are 0 Hz, then:</p> <ul style="list-style-type: none"> <li>• Check for injection locking. Refer to <i>Minimizing Injection Locking</i> in Chapter 3 of the Operating Manual for further information.</li> </ul>
<p><b>8</b></p>	<p><b>Unable to find a beatnote.</b> System was not able to detect a beatnote above <math>-24</math> dBm (20 mVpk) between 0.1 Hz and 40 MHz.</p> <p><b>Action:</b> Verify the presence of the beatnote signal. (Refer to the <i>Checking the Beatnote</i> procedure provided in each Phase Lock Loop measurement example in Chapter 3 of the Operating Manual.) If you are making a Phase lock loop measurement, be sure the VCO Tuning Constant value entered for the measurement is within a factor of 2 of the actual value. Refer to <i>Calibration Process</i> in Chapter 2, Measurement Definitions for information about the beatnote calibration technique.</p>
<p><b>9</b></p>	<p><b>The calibration spur could not be found.</b> The system was unable to detect a spur within a factor of 2 of the entered spur frequency.</p> <p><b>Action:</b></p> <ol style="list-style-type: none"> <li>1. Check that the correct spur frequency was entered.</li> <li>2. Verify the output signal from the spur source.</li> <li>3. Increase the spur level up to but not exceeding a maximum of <math>-20</math> dBc.</li> </ol> <p style="text-align: center;"><b>NOTE</b></p> <p style="text-align: center;"><i>If a single sided spur is being used and the source frequency is adjusted to maintain quadrature, the frequency of the spur source will also have to be adjusted to maintain the desired spur offset.</i></p>
<p><b>10</b></p>	<p><b>Waveform departs too drastically from sinusoidal to be used in calculation of the Phase Detector Constant.</b> The system measures the slope of the waveform at both the positive and the negative zero crossings. If the true slopes differ in magnitude by more than 10%, Error 10 is generated.</p> <p><b>Action:</b> Check the harmonic content of the two input signals to the Phase Detector. All even harmonics must be below <math>-20</math> dBc to guarantee good symmetry of the beatnote waveform. If possible, increase the PTR to <math>&gt;10</math> kHz so that the beatnote is <math>&gt;1</math> kHz. Then the HP 3048A will measure the fundamental and its harmonics. (<math>&lt;1</math> kHz beatnote system measures slope of sinusoid.)</p>

Table 8-1. Numbered Error Messages (11 of 17)

11

**DC offset too large. Waveform does not cross 0 volts.** This error occurs when the system is measuring the Phase Detector Calibration Constant and one of the following conditions exist.

1. The dc offset is greater than the peak beatnote voltage due to a large dc offset or a low beatnote level.
2. The beatnote frequency is much lower than expected and only the top or bottom portion of a sine wave peak is actually measured.

**Action:**

1. Observe the beatnote on the time record of the HP 3561A or on an oscilloscope connected to the AUX MONITOR port of the HP 11848A. Verify that the beatnote amplitude is correct for the signal level at the R input port on the HP 11848A. Figure 8-4 shows the relationship between the beatnote level and the level at the R input port.

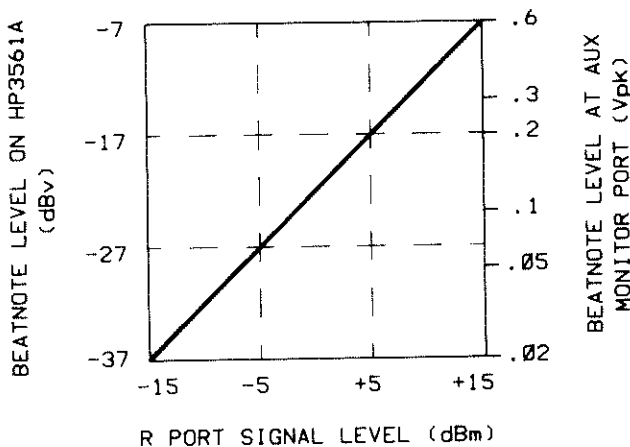

Figure 8-4. Beatnote Level Relative to the Signal Level at the R Port.

2. Verify that the phase detector DC offset is  $< 30$  mV ( $< 50$  mV if you are using the 1.2 to 1.8 GHz Phase Detector).
3. If the HP 3048A was not configured to measure the VCO Tuning Constant, verify that the entered value is within a factor of 2 of the VCO's actual Tuning Constant. A procedure for verifying the VCO's Tuning Constant is contained in *Estimating the Tuning Constant* in Chapter 3 of the Operating Manual.
4. When the system measures the Phase Detector Constant, the beatnote frequency should be set to approximately 10% of the Peak Tuning Range (PTR) set for the measurement. If it is not, verify the VCO Tuning Constant and Voltage Tuning Range entered for the measurement.

**Table 8-1. Numbered Error Messages (12 of 17)**

<p><b>12</b></p>	<p><b>Insufficient span. Less than one waveform found.</b> A minimum of four zero crossings is necessary across the HP 3561A's display. This error occurs when the system is measuring the Phase Detector Constant and the expected beatnote is &lt; 1 kHz.</p> <p><b>Action:</b> When the system measures the Phase Detector Constant, the beatnote frequency should be set to approximately 10% of the Peak Tuning Range (PTR) set for the measurement. If it is not, verify the VCO Tuning Constant and Voltage Tuning Range entered for the measurement. A procedure for evaluating the tuning sensitivity of the VCO is provided in <i>Estimating the Tuning Constant</i> in Chapter 3 of the Operating Manual.</p>															
<p><b>13</b></p>	<p><b>The (File) does not exist in the current (Directory) and has not been loaded.</b> This error occurs when the HP 3048A attempts to load a file and the disc containing that file is not present in the designated mass storage device.</p> <p><b>Action:</b> Insert the disc containing the required file and proceed.</p>															
<p><b>14</b></p>	<p><b>DC offset from mixer &gt; 1/2 peak voltage.</b> The dc offset of the Phase Detector is determined and then used to adjust the Phase Detector calibration constant for true slope at the zero voltage point.</p> <p><b>Action:</b> Observe the beatnote on the HP 3561A display or with an oscilloscope connected to the AUX MONITOR port on the HP 11848A.</p> <ol style="list-style-type: none"> <li>1. Verify that the beatnote amplitude is correct for the signal level at the R input port on the HP 11848A. Figure 8-5 shows the relationship between the beatnote level and the level at the R port.</li> </ol> <div data-bbox="440 976 1072 1417" data-label="Figure"> <table border="1"> <caption>Data points for Figure 8-5</caption> <thead> <tr> <th>R Port Signal Level (dBm)</th> <th>Beatnote Level at HP3561A (dBv)</th> <th>Beatnote Level at AUX MONITOR PORT (Vpk)</th> </tr> </thead> <tbody> <tr> <td>-15</td> <td>-37</td> <td>0.02</td> </tr> <tr> <td>-5</td> <td>-27</td> <td>0.05</td> </tr> <tr> <td>+5</td> <td>-17</td> <td>0.1</td> </tr> <tr> <td>+15</td> <td>-7</td> <td>0.2</td> </tr> </tbody> </table> </div> <p><b>Figure 8-5. Beatnote Level Relative to the Signal Level at the R Port.</b></p>	R Port Signal Level (dBm)	Beatnote Level at HP3561A (dBv)	Beatnote Level at AUX MONITOR PORT (Vpk)	-15	-37	0.02	-5	-27	0.05	+5	-17	0.1	+15	-7	0.2
R Port Signal Level (dBm)	Beatnote Level at HP3561A (dBv)	Beatnote Level at AUX MONITOR PORT (Vpk)														
-15	-37	0.02														
-5	-27	0.05														
+5	-17	0.1														
+15	-7	0.2														



**Table 8-1. Numbered Error Messages (13 of 17)**

<p><b>14</b> (cont'd)</p>	<p>2. Verify that the Phase Detector DC offset is <math>&lt; 30</math> mV (<math>&lt; 50</math> mV for the 1.2 to 1.8 GHz Phase Detector). If the dc offset is within this limit and the beatnote level is <math>&lt; -23</math> dBV (<math>&lt; 0.1</math> Vpk at AUX MONITOR port), increase the beatnote level, if possible, by increasing the signal level at the R port. If the beatnote level cannot be increased sufficiently it may be necessary to decrease the dc offset by changing the carrier frequency.</p>															
<p><b>15</b></p>	<p><b>Detector Constant <math>&lt; 0.02</math> V/Rad.</b> The measured Phase Detector Constant was below the system's 20 mV limit.</p> <p><b>Action:</b> Observe the beatnote on the HP 3561A display or with an oscilloscope connected to the AUX MONITOR port on the HP 11848A. Verify that the beatnote amplitude is correct for the signal level at the R input port on the HP 11848A. Figure 8-6 shows the relationship between the beatnote level and the level at the R port. If necessary, increase the signal level at the R port and verify that the signal level at the L port is <math>\geq +15</math> dBm (<math>\geq +7</math> dBm for the 1.2 GHz to 18 GHz Phase Detector).</p> <div data-bbox="360 893 987 1337" data-label="Figure"> <table border="1"> <caption>Data points for Figure 8-6</caption> <thead> <tr> <th>R Port Signal Level (dBm)</th> <th>Beatnote Level on HP3561A (dBv)</th> <th>Beatnote Level at AUX Monitor Port (Vpk)</th> </tr> </thead> <tbody> <tr> <td>-15</td> <td>-37</td> <td>0.02</td> </tr> <tr> <td>-5</td> <td>-27</td> <td>0.05</td> </tr> <tr> <td>+5</td> <td>-17</td> <td>0.2</td> </tr> <tr> <td>+15</td> <td>-7</td> <td>0.6</td> </tr> </tbody> </table> </div> <p><b>Figure 8-6. Beatnote Level Relative to the Signal Level at the R Port.</b></p>	R Port Signal Level (dBm)	Beatnote Level on HP3561A (dBv)	Beatnote Level at AUX Monitor Port (Vpk)	-15	-37	0.02	-5	-27	0.05	+5	-17	0.2	+15	-7	0.6
R Port Signal Level (dBm)	Beatnote Level on HP3561A (dBv)	Beatnote Level at AUX Monitor Port (Vpk)														
-15	-37	0.02														
-5	-27	0.05														
+5	-17	0.2														
+15	-7	0.6														

Table 8-1. Numbered Error Messages (14 of 17)

<h1>16</h1>	<p><b>Detector Constant &gt; 10 V/Rad.</b> The measured Phase Detector Constant exceeded the system's 10 V limit.</p> <p><b>Action:</b> Observe the beatnote on the HP 3561A display or with an oscilloscope connected to the AUX MONITOR port on the HP 11848A. Verify that the beatnote amplitude is correct for the signal level at the R input port on the HP 11848A. Figure 8-7 shows the relationship between the beatnote level and the level at the R port. If necessary, decrease the signal level at the R port.</p> <div style="text-align: center;"> <table border="1" style="margin: 10px auto;"> <caption>Data points for Figure 8-7</caption> <thead> <tr> <th>R Port Signal Level (dBm)</th> <th>Beatnote Level on HP3561A (dBv)</th> <th>Beatnote Level at AUX Monitor Port (Vpk)</th> </tr> </thead> <tbody> <tr> <td>-15</td> <td>-37</td> <td>0.02</td> </tr> <tr> <td>-5</td> <td>-27</td> <td>0.05</td> </tr> <tr> <td>+5</td> <td>-17</td> <td>0.2</td> </tr> <tr> <td>+15</td> <td>-7</td> <td>0.6</td> </tr> </tbody> </table> </div> <p><b>Figure 8-7. Beatnote Level Relative to the Signal Level at the R Port.</b></p>	R Port Signal Level (dBm)	Beatnote Level on HP3561A (dBv)	Beatnote Level at AUX Monitor Port (Vpk)	-15	-37	0.02	-5	-27	0.05	+5	-17	0.2	+15	-7	0.6
R Port Signal Level (dBm)	Beatnote Level on HP3561A (dBv)	Beatnote Level at AUX Monitor Port (Vpk)														
-15	-37	0.02														
-5	-27	0.05														
+5	-17	0.2														
+15	-7	0.6														
<h1>17</h1>	<p><b>Measured Tuning Range of VCO is less than 0.2 Hz.</b> The system was probably unable to cause a beatnote.</p> <p>The Tuning Range of the VCO is measured in this case as:  <math>2 \times \text{Entered Voltage Range of VCO} \times \text{Measured VCO Tuning Constant}</math></p> <p><b>Action:</b> If the <i>expected</i> tuning range of the VCO source is much larger than 0.2 Hz:</p> <ol style="list-style-type: none"> <li>1. Check the Tune Voltage cable connection.</li> <li>2. Verify that the VCO source's tuning capability is enabled.</li> <li>3. Verify the VCO's tuning response by performing the procedure provided in <i>Estimating the Tuning Constant</i> in Chapter 3 of the Operating Manual.</li> <li>4. Perform the procedure for adjusting the beatnote frequency to within 10% of the Peak Tuning Range (PTR) set for the measurement. (The procedure for adjusting the beatnote is provided in the <i>Checking the Beatnote</i> portion of each measurement example in Chapter 3 of the Operating Manual.</li> </ol> <p>If the <i>expected</i> tuning range of the VCO source is near 0.2 Hz:</p> <ol style="list-style-type: none"> <li>1. Increase the tuning range, if possible, by increasing the Voltage Tune Range value entered for the measurement.</li> </ol>															

**Table 8-1. Numbered Error Messages (15 of 17)**

<p><b>18</b></p>	<p><b>The system perceives that the signals from the two sources differ by more than 15% of the VCO Tuning Range. The sources may be retuned to reduce the beatnote frequency, or the VCO Tuning Range may be adjusted.</b></p> <p>Once the HP 3048A has measured the VCO Tuning Constant, it is able to predict the tune voltage necessary to phase lock the loop. If the tuning range required for lock is &gt; 15% of the Peak Tuning Range (PTR), The system may not be able to pull the sources into lock, and will have very little tuning range (&lt; 5% of PTR) left for drift tracking.</p>
	<p><b>Action:</b></p> <ol style="list-style-type: none"> <li>1. Tune the center frequency of one or both sources to adjust the beatnote to within the Capture Range set for the measurement. As you adjust the beatnote frequency toward 0 Hz, you may find it helpful to press the <b>Span</b> softkey to decrement the analyzer's span setting. (A complete procedure for adjusting the beatnote is provided in the <i>Checking the Beatnote</i> portion of each Phase Lock Loop measurement example in Chapter 3 of the Operating Manual.)</li> <li>2. If necessary, change the Center Voltage value entered for the VCO to reduce the initial beatnote frequency, or increase the Tuning Voltage Range entered for the VCO to provide a larger Peak Tuning Range (PTR). (Details on adjusting the PTR are provided in <i>Changing the PTR</i> in Chapter 3 of the Operating Manual.)</li> </ol>
<p><b>19</b></p>	<p><b>There is no HP 3585A in the configuration table.</b> This task requires that an HP 3585A Spectrum Analyzer is configured into the HP 3048A system.</p>
	<p><b>Action:</b> Enter an HP 3585A into the System Configuration Table.</p>
<p><b>20</b></p>	<p><b>Unable to detect presence of HP 3561A noise source. Check cabling and HP 3516A Noise Source Function.</b></p>
	<p><b>Action:</b> Verify that the HP 3561A rear-panel "Source Out" port is connected to the HP 11848A rear-panel "Noise Input" port.</p>
<p><b>21</b></p>	<p><b>User tone not within +/-500 Hz of 55 KHz. Press re-try if you wish to re-adjust and continue. The frequency of the tone generator is not close enough to the required limits.</b></p>
	<p><b>Action:</b> Adjust tone generator if possible. If the tone generator cannot meet this requirement, replace it with one that can.</p>

Table 8-1. Numbered Error Messages (16 of 17)

<p><b>22</b></p>	<p><b>User tone not within <math>\pm 5</math> dB of <math>-60</math> dBc. Press re-try if you wish to re-adjust and continue. The level from the tone generator is not close enough to the required limits.</b></p> <p><b>Action:</b> Adjust tone generator if possible. If the tone generator cannot meet this requirement, replace it with one that can to perform this test.</p>
<p><b>23</b></p>	<p><b>Warning. Measurement has not been calibrated. 'New Msrmnt' should be requested.</b> Repeat Measurement or Noise Monitor was selected.</p> <p><b>Action:</b> Select New Measurement or New Noise Monitor to allow the system to calibrate the measurement.</p>
<p><b>24</b></p>	<p><b>No printer found in system configuration, Performance Tests cannot be initiated.</b> The Performance Tests require a printer to be connected to the system and entered in the System Configuration Table.</p> <p><b>Action:</b> Connect a printer and enter the appropriate information into the System Configuration Table.</p>
<p><b>25</b></p>	<p><b>Printer is not responding. Performance test cannot be initiated. Correct problem and Press 'Retry'.</b> The system cannot find the printer as addressed in the System Configuration Table.</p> <p><b>Action:</b> Be sure the printer is connected on the system HP-IB bus. Verify that the printer is turned on and is set to the same address as is listed in the System Configuration Table.</p>
<p><b>26</b></p>	<p><b>The system attempted to set (instrument) to (–) MHz.</b> The source was not able to respond to the frequency setting defined (or computed) for the measurement.</p> <p><b>Action:</b> Verify that the Instrument Parameters defined for the measurement are correct and that the source's frequency range is adequate.</p>
<p><b>27</b></p>	<p><b>The entered carrier frequency cannot be measured.</b> The HP 11729C cannot generate an intermediate frequency between 4.9 MHz and 1280 MHz for this carrier frequency.</p> <p><b>Action:</b> Verify the carrier frequency. If the frequency is correct, verify the HP 11729C filter table in the System Configuration Table.</p>

Table 8-1. Numbered Error Messages (17 of 17)

<b>28</b>	<b>Unable to disable PLL integrator by setting out-of-lock flip-flop. Test 03 results may be invalid. Fix the problem and try again. Test 03 will be aborted upon pressing 'Proceed' or 'Abort'.</b>
	<b>Action:</b> Troubleshoot and repair the HP 11848A Phase Noise Interface. Refer to the HP 11848A Service Manual for Troubleshooting information.
<b>29</b>	<b>Unable to disable PLL integrator by setting out-of-lock flip-flop. Test 09 results may be invalid. Fix the problem and try again. Test 09 will be aborted upon pressing 'Proceed' or 'Abort'.</b>
	<b>Action:</b> Troubleshoot and repair the HP 11848A Phase Noise Interface. Refer to the HP 11848A Service Manual for Troubleshooting information.
<b>30</b>	<b>Unable to disable PLL integrator by setting out-of-lock flip-flop. Test 10 results may be invalid. Fix the problem and try again. Test 10 will be aborted upon pressing 'Proceed' or 'Abort'.</b>
	<b>Action:</b> Troubleshoot and repair the HP 11848A Phase Noise Interface. Refer to the HP 11848A Service Manual for Troubleshooting information.
<b>110</b>	<b>Random noise obscures waveform.</b> The system is unable to measure the Detector Constant due to an erratic waveform. This error occurs during the Phase Detector Constant calibration.
	<b>Action:</b> Observe spectrum of beatnote and evaluate with respect to small angle criterion for expected PLL BW.

**Table 8-2. Unnumbered Error Messages (1 of 2)**

<p><b>Bad segment definitions.</b> The defined segments do not include the 100 kHz offset data point when accessing the Noise Monitor and New Noise Monitor.</p> <p><b>Action:</b> Define the Segment Table to include 100 kHz.</p>
<p><b>Cannot use the specified Tuning Constant.</b> The Tuning Constant was set to zero because the last New Measurement was aborted.</p> <p><b>Action:</b> Define a method for determining the VCO Tuning Constant other than use the current Tuning Constant. Then select <input type="text" value="New Msrmnt"/> .</p>
<p><b>External Timebase not allowed with Internal Source.</b></p> <p><b>Action:</b> Redefine the timebase in the Source Control display.</p>
<p><b>Files not created using identical segments.</b> The 2 Oscillator Comparison or the 3 Oscillator Comparison can only be performed using data acquired from identical segments and measurement spans.</p> <p><b>Action:</b> Remeasure the devices. Do not change any Segment Table entries between measurements or measurement definitions.</p>
<p><b>ILLEGAL DATA TYPE.</b> The system expected a numeric value to be entered.</p> <p><b>Action:</b> Enter numeric value only.</p>
<p><b>Insufficient data files for 3 Oscillator Comparison.</b> Less than three Result Files were found in the specified Mass Storage Media.</p> <p><b>Action:</b> Store a Result File for each of the three measurements to be compared on the same Mass Storage Media.</p>
<p><b>Insufficient data files for 2 Oscillator Comparison.</b> Less than two Result Files were found in the specified Mass Storage Media.</p> <p><b>Action:</b> Store a Result File for each of the two measurements to be compared on the same Mass Storage Media. (Note that these files cannot be identical, they must be distinct measurements).</p>
<p><b>Internal sources may not be used to drive the high frequency detector.</b> The HP 11848A internal oscillators can not be used as the input for the 1.2 to 1.8 GHz phase detector.</p> <p><b>Action:</b> Define a different source or phase detector.</p>
<p><b>No test-instruments defined.</b> Measurement initiated with an empty Configuration Table.</p> <p><b>Action:</b> Define the equipment being used in the System Configuration Table.</p>

**Table 8-2. Unnumbered Error Messages (2 of 2)**

**Peak tuning range exceeds Hz.** The maximum Peak Tuning Range is 500 kHz (or 200 MHz when using a configured RF Analyzer).

**Action:** Reduce the Peak Tuning Range by reducing the Tuning Voltage or Tuning Constant value defined for the VCO source in the Instrument Parameters display.

**Plot range is not within span range.** A Plotted Range has been defined that is not within the Measurement Range specified in the segment tables.

**Action:** Define each of the Plotted Ranges in the Segment Table so they are each within the Measurement Ranges defined in the table.

**Range limits must be in ascending order.** A segment has been defined with a lower limit greater than the upper limit.

**Action:** Redefine the segment range so that the upper limit is greater than the lower limit.

**Source specification is invalid and must be corrected.** The system has detected an error in the Source Control definition.

**Action:** Check the Source Control Diagram for accuracy and compatibility with other parameters defined for the measurement.

**The currently defined measurement has not been properly calibrated. Select 'New Msrmnt' or 'New Noise Monitor' to calibrate.** The Phase Detector Constant or VCO Tuning Constant has not been calibrated.

**Action:** Check that the appropriate calibration method has been defined in the Calibration Process display. Select  or a  to initiate calibration.

**The frequency of the Internal 400 MHz Osc. cannot be tuned.** The system cannot obtain quadrature since the HP 11848A internal 400 MHz oscillator cannot be tuned.

**Action:** Use a tunable source or manually adjust quadrature using a phase shifter or line stretcher.

**Tune line improperly connected.** The Tune Line is connected to a non-tunable source in the Source Control Diagram. A VCO source is required for Phase Lock Loop Measurements.

**Action:** Connect the Tune Line to a VCO source in the Source Control Diagram.

Table 8-2. Unnumbered Error Messages (2 of 2)

**'10 MHz A' and internal '400 MHz Osc./VCO' are mutually exclusive. 10 MHz A cannot operate while one of the 400 MHz Oscillators is on.**

**Action:** Redefine the source selections on the Source Control Diagram.

**3561A Noise Source not functioning or not connected to 11848A.** The HP 11848A can not detect the required noise source for this setup.

**Action:** Verify that the HP 11848A's rear-panel noise input is connected to the HP 3561A's SOURCE OUT and attempt to re-run the test.



Table 8-3. Reference Messages (1 of 7)

<p><b>1</b></p>	<p><b>Establish quadrature manually.</b></p>
	<p><b>Action:</b> Manually adjust the source frequency or the phase shifter to attain quadrature (within <math>\pm 1</math> division of center scale on the HP 11848A's Quadrature Meter). If the meter is pegged, connect an oscilloscope or voltmeter to the AUX MONITOR port on the HP 11848A and then adjust the source frequency or the phase shifter to decrease voltage level until the level can be observed on the quadrature meter.</p>
<p><b>2</b></p>	<p><b>The FM Deviation on the (source) will be changed from ___ to ___ Hz.</b> In order to zero the beatnote, the HP 3048A had to change the center frequency of the source. As a result, FM Deviation must be adjusted to within the limits of the source at the new frequency. Note that a reduced Tuning Constant (deviation) will result in a narrower Peak Tuning Range (PTR) for the measurement.</p> <p><b>Action:</b> If the narrower PTR is adequate for the measurement, proceed. If the resulting PTR will not provide sufficient Capture and Drift Tracking Ranges for the stability of the signal sources, you may need to select a different VCO source with a greater tuning range.</p> <p>If your VCO source is an HP 8642A/B and the carrier frequency for the measurement is <math>&lt; 123</math> MHz, the following steps will enable you to increase the tuning range of the HP 8642A/B.</p> <ol style="list-style-type: none"> <li>1. Configure the HP 3048A Source Control block diagram for manual control of the HP 8642A/B.</li> <li>2. Select the HP 8642A/B HET Band for 1.5 MHz maximum deviation. Note that the increase in deviation causes an increase in the HP 8642A/B's noise level as well.</li> </ol>

Table 8-3. Reference Messages (2 of 7)

<b>3</b>	<p><b>Cause FIRST calibration PEAK voltage at mixer input.</b></p> <p><b>Action:</b> Adjust the frequency of the source, or adjust the phase shifter to get either a positive or negative peak voltage reading using the Marker function on the HP 3561A. To ensure that you have adjusted to the maximum peak setting, adjust to slightly beyond the maximum peak and then back to it. (The peak voltage setting can also be determined using a voltmeter or oscilloscope connected to the AUX MONITOR port on the HP 11848A.) When the peak setting has been attained, press <span style="border: 1px solid black; padding: 2px;">Proceed</span> .</p> <p>When you are prompted to cause the second calibration peak, adjust to a maximum peak of the opposite polarity using the same technique.</p> <p style="text-align: center;"><b>NOTE</b></p> <p><i>For this calibration technique to be most accurate, the two signal paths to the HP 11848A Phase Detector should be well matched (&gt;10 dB return loss) and the R port level should be at least 5 dB below the L port level. If you are not able to attain a true peak setting, you will have to use a different calibration technique.</i></p>
<b>4</b>	<p><b>Apply modulation to carrier.</b> Either a double-sided spur or modulation of the same type as is being measured.</p> <p><b>Action:</b> Apply the modulation type required for your measurement. Apply angle modulation for a Phase Noise without PLL or FM discriminator measurement, or apply amplitude modulation for an AM measurement. Ensure that the modulation is applied at a level that will enable the HP 3048A to readily detect it above the noise of the device-under-test. The following maximum limits should also be observed.</p> <ul style="list-style-type: none"> <li>• Double-sided spur &lt; -20 dB</li> <li>• AM &lt; 10% (-26 dB)</li> </ul> <p>The offset frequency of the spur should be between 1 Hz and 50 kHz (or between 1 Hz and 20 MHz if an RF Analyzer is configured in the system).</p>
<b>5</b>	<p><b>Apply calibration spur to carrier.</b> A single-sided spur is expected.</p> <p><b>Action:</b> The spur is typically generated by combining a signal near the frequency of the device-under-test (DUT) with the DUT output. This can be done using a power splitter or a directional coupler.</p> <p>Turn on the spur signal source and note the amplitude of the spur signal relative to the amplitude of the DUT. The spur level should be high enough to be readily observable above the noise of the DUT on a spectrum analyzer. The spur level should not exceed -20 dBc relative to the DUT amplitude.</p>

**Table 8–3. Reference Messages (3 of 7)**

<p><b>6</b></p>	<p><b>Remove the calibration spur.</b> If the spur signal is not removed, it will appear in the measurement and could affect the measurement results.</p>
	<p><b>Action:</b> Disconnect or turn off the spur source without disturbing the frequency or amplitude settings of the source.</p> <p style="text-align: center;"><b>NOTE</b></p> <p><i>If you wish to determine the frequency and amplitude of you spur source, leave the source connected and turned on during the measurement. The spur signal should appear in your measurement results. Note, however, that a large spur signal can prevent the system from having the full dynamic range necessary to make a valid noise measurement.</i></p>
<p><b>7</b></p>	<p><b>Offset the source and reference signals by at least 1 Hz and not more than 20 MHz.</b> The system requires that two different signals be applied to the input ports of the HP 11848A's Phase Detector. The frequencies of the two sources must differ as follows:</p> <p>With RF Spectrum Analyzer in System . . . . . Offset Range: 1 Hz to 20 MHz  Without RF Spectrum Analyzer in System . . . . . Offset Range: 1 Hz to 50 kHz</p>
	<p><b>Action:</b> Adjust the frequency of the device-under-test (DUT) to offset it from the reference source frequency.</p> <p>If the DUT cannot be adjusted to create a frequency offset that is within the offset range specified above, substitute a different source for the DUT. Adjust the substitute source for the same power level as the DUT source it is replacing. Terminate any ports in 50Ω that are not connected during the substitution. Reconnect the DUT source after the calibration is completed.</p>
<p><b>8</b></p>	<p><b>Remove the beatnote and connect the system for noise measurement.</b></p>
	<p><b>Action:</b> Readjust the device-under-test (DUT) to the frequency of the reference source or reconnect DUT.</p>
<p><b>9</b></p>	<p><b>Phase lock has been lost.</b> This message can be caused by any one of the following conditions.</p> <ol style="list-style-type: none"> <li>1. Frequency drift &gt; 25% of the Peak Tuning Range.</li> <li>2. A phase transient &gt; 0.25 radians.</li> <li>3. Out-of-Lock detector set by search oscillator.</li> </ol>

**Table 8-3. Reference Messages (4 of 7)**

<p><b>9</b> (cont'd)</p>	<p><b>Action:</b> Press the <b>Proceed</b> key to cause the HP 3048A to attempt to relock the loop and re-measure the frequency segment. If the HP 3048A is unable to relock the loop, Error 4 will be displayed, refer to Error 4 for recommended actions. (Note that this error is most typically caused by frequency drift of one of the sources. If this condition persists, it may be necessary to increase the Peak Tuning Range for the measurement.)</p>
<p><b>10</b></p>	<p><b>The LNA is currently IN/OUT. This may be changed via the 'Toggle LNA' key.</b> This message only appears if the PULSED Carrier Type has been selected. The HP 3048A evaluates the total noise from the Phase Detector to determine whether the Low-Noise-Amplifier (LNA) should be switched IN or OUT. The LNA is normally switched in to provide the maximum measurement sensitivity for the system.</p> <p>If the system determines that the noise level from the Phase Detector will overload the LNA, the LNA is switched out. When the LNA is switched out, the system's measurement sensitivity is degraded by 20 to 30 dB depending on the offset frequency. If you are measuring a device that has a very low noise level (near the system's noise floor) this degradation may affect the measurement results.</p> <p><b>Action:</b> Under most condition it is recommended that you proceed with the decision made by the system. Toggling the LNA IN when the HP 3048A has determined it should be switched OUT can cause the noise from the Phase Detector to be compressed and the measurement results to be inaccurate.</p> <p>There are certain conditions when you may want to toggle the LNA OUT, however.</p> <ol style="list-style-type: none"> <li>1. When Pulse Mode is enabled. If the Phase Detector dc offset is <math>&gt; 5</math> mVdc, the system may not detect that the noise level is high enough to overload the LNA.</li> <li>2. To duplicate the exact conditions that existed for a previous measurement where the LNA was switched out.</li> <li>3. When you are performing the System Noise Floor Test and you wish to evaluate the system's noise floor without the LNA in the measurement path.</li> </ol> <p>If the system has decided to switch OUT the LNA and you are concerned about measurement sensitivity, you may wish to further evaluate the decision. Connect an oscilloscope to the AUX Monitor Port on the HP 11848A. Observe the LNA output and toggle the LNA IN. If the peak output level exceeds <math>-0.5V</math> or <math>+1V</math>, the noise may be clipped or compressed so the measurements must be made with the LNA OUT. If the noise is not significantly clipped, the measurement may be made with the LNA IN.</p>

Table 8–3. Reference Messages (5 of 7)

<p><b>11</b></p>	<p><b>The LNA of the HP 11848A has been bypassed. This will result in a degradation of the system noise floor.</b> The HP 3048A evaluates the total noise from the Phase Detector to determine whether the Low-Noise-Amplifier (LNA) should be switched IN or OUT. The LNA is normally switched in to provide the maximum measurement sensitivity for the system.</p> <p>If the system determines that the noise level from the Phase Detector will overload the LNA, the LNA is switched out. When the LNA is switched out, the system's measurement sensitivity is degraded by 20 to 30 dB depending on the offset frequency. If you are measuring a device that has a very low noise level (near the system's noise floor) this degradation may affect the measurement results.</p>
	<p><b>Action:</b> Proceed with the measurement. When the measurement is complete, evaluate the results to determine the possible causes of the high noise level at the Phase Detector output. A few possible causes are:</p> <ol style="list-style-type: none"> <li>1. A large spur (<math>&gt; -40</math> dBc) on one of the input signals.</li> <li>2. A high noise pedestal on one of the sources.</li> <li>3. Spurs at the output of the Phase Detector.</li> </ol> <p>To determine whether bypassing the LNA has affected your noise measurement results, compare your results to the noise floor provided by the system when the LNA is OUT. Use the Phase Detector Constant value measured by the HP 3048A to determine the system's noise floor with the LNA OUT from the Approximate HP 3048A Phase Noise Floor vs R port Signal Level (See Graph 1 in Quick Reference Guide) graph. If it appears that your measurement may have been limited by the system's noise floor with the LNA bypassed, it may be necessary to take one of the following actions to prevent the LNA from being switched out.</p> <ol style="list-style-type: none"> <li>1. Reduce the Phase Detector Calibration Constant by reducing the signal level into the R port of the Phase Detector. Then reinitiate a New Measurement.</li> <li>2. Suppress the noise and spurs at the Phase Detector output by increasing the Phase Lock Loop (PLL) bandwidth. The PLL bandwidth is increased by increasing the Peak Tuning Range (PTR) for the measurement. Details on increasing the PTR are provided in <i>Changing the PTR</i> in Chapter 3 of the Operating Manual.</li> </ol> <p>If you wish to further evaluate the LNA decision, abort the measurement and access the Special Functions display. Select the PULSED Carrier Type and then initiate a Repeat Measurement. When the LNA decision is displayed again, connect an oscilloscope to the AUX Monitor port or the HP 11848A. Observe the LNA output and toggle the LNA IN. If the peak output level exceeds <math>-0.5V</math> or <math>+1V</math>, the noise may be clipped or compressed so the measurements must be made with the LNA OUT. If the noise is not significantly clipped, the measurement may be made with the LNA IN.</p>
<p><b>12</b></p>	<p><b>A comparison of theoretical and actual PLL suppression indicates a degradation of the accuracy specified for the HP 11848A.</b> The Phase Lock Loop (PLL) Suppression is verified by measuring the actual loop suppression at frequencies near the predicted PLL bandwidth. This message is displayed when the measured loop suppression differs from the theoretical by <math>&gt; 1</math> dB.</p>

**Table 8-3. Reference Messages (6 of 7)**

**12**  
(cont'd)

**Action:**

1. The key factor for having a good match between the measured loop suppression and the theoretical is the accuracy of the Phase Detector Constant and the VCO Tuning Constant. Abort the measurement and verify that these calibration constants are accurate.
  - a. Verify that the VCO Tuning Constant entered for the measurement is within a factor of 2 of the VCO's actual tuning constant. (A procedure for evaluating the sensitivity of your VCO is provided in *Estimating the Tuning Constant* in Chapter 3 of the Operating Manual.)
  - b. Verify the Phase Detector Constant by connecting an oscilloscope to the AUX MONITOR port on the HP 11848A. The peak voltage at the AUX MONITOR port should equal the Phase Detector Constant measured by the system.
2. If the calibration constants are accurate, begin a New Measurement and proceed to the hardware Connect Diagram. Observe the beatnote signal on the HP 3561A using the *Checking the Beatnote* procedure provided in each PLL measurement example in Chapter 3 of the Operating Manual.
  - a. Verify that the beatnote signal is sinusoidal (or triangular if the input signals are square waves or if the levels of both input signals are  $> +15$  dBm).
  - b. Verify that all even harmonics are  $\leq -30$  dBc on the beatnote and  $\leq -20$  dBc on the input signals.
  - c. Check for injection locking.
  - d. Check for noise that exceeds the small angle line. (Refer to *Evaluating Noise Above the Small Angle Line* in Chapter 3 of this manual for a procedure.)
3. If the beatnote signal meets the preceding tests, proceed with a New Measurement. If this same message is displayed again, press the **Suppr. Plot** key to access a plot of the PLL suppression curve.
  - a. If the measured curve does not match the theoretical because it is noisy, press **Proceed Theor** to proceed with the measurement using the theoretical PLL suppression data. The accuracy of the measurement results will be unverified but the results may help you to identify the source of the problem.
  - b. If the measured curve does not match the theoretical because it has high peaks and the Accuracy Spec. Degradation is  $\leq 2$  dB, press **Proceed w/Adj** to proceed with the measurement using an adjusted PLL suppression. The accuracy of the results will be degraded by 2 dB within a decade of the PLL bandwidth for the measurement. Figure 8-8 shows PLL bandwidth relative to the Peak Tuning Range (PTR) set by the VCO source. (Refer to Chapter 2, Measurement Definitions for further information about the PTR.)

**Table 8-3. Reference Messages (7 of 7)**

<p><b>12</b> (cont'd)</p>	<p>c. If the Acc. Spec. Deg. is &gt;2 dB, perform steps 1. and 2. again very carefully, pay close attention to the accuracy of the calibration constants and injection locking. If the Acc. Spec. Deg. is still &gt;2 dB, press Proceed W/Adj to get an approximate noise measurement for use in further troubleshooting the problem.</p> <div data-bbox="387 308 1041 786" data-label="Figure"> <p>The figure is a log-log plot with the y-axis labeled 'PLL Bandwidth (Hz)' ranging from 0.1 to 1M and the x-axis labeled 'Peak Tuning Range (Hz)' ranging from 0.1 to 1G. A solid line represents the relationship, showing a step increase at 10 Hz. Seven dashed lines, labeled 0 through 7, branch off from the main line at various points, representing different filter settings. Line 0 is at approximately 100 Hz, line 1 at 200 Hz, line 2 at 400 Hz, line 3 at 800 Hz, line 4 at 1.6 kHz, line 5 at 3.2 kHz, line 6 at 6.4 kHz, and line 7 at 12.8 kHz.</p> </div> <p><b>Figure 8-8. Phase Lock Loop Bandwidth Relative to the Peak Tuning Range.</b></p>
<p><b>13</b></p>	<p><b>Establish a beatnote less than or equal to ( ) Hz.</b> System perceives that sources are not within 5% of the defined Peak Tuning Range. Since the Reference Source is under manual control, the user is required to establish zerobeat.</p> <p><b>Action:</b> Manually adjust the Reference Source to acquire a beatnote on the analyzer (on oscilloscope if corrected to the HP 11848A any monitor port) of less than or equal to the specified frequency.</p>
<p><b>100</b></p>	<p><b>There is no HP 3585A present in the configuration table.</b> If the adjustment of A4C32 is desired, press 'ABORT' at this time and update the configuration table. A4C32 adjusts the peaking of the LNA above 20 MHz. The HP 3048A only supports the HP 3585A/B for this adjustment. This adjustment is only required if the LNA or the portion of the A4 board has been repaired or of the performance of the LNA &gt;20 MHz is in question.</p>
<p><b>102</b></p>	<p><b>'CALDATAHI' and 'CALDATALO' will be restored from disc files.</b> Cal data in memory is in a unknown state. System will restore cal data from the mass storage media file.</p>
<p><b>103</b></p>	<p><b>NO PRINTER FOUND IN SYSTEM CONFIGURATION.</b> Functional Checks require a printer be configured in the system.</p> <p><b>Action:</b> Connect a printer to the system, and enter it in the System Configuration Table.</p>

**Table 8-4. Warning Messages**

<p><b>Calibration AM Rate changed...</b> This warning informs the user of an automatic change in AM rate for the Calibration Source. The message occurs at test time to inform the user that some parameters have changed.</p>
<p><b>Calibration FM DEV changed from...</b> This warning informs user of an automatic change in FM Deviation for the Reference Oscillator or Calibration Source. The message occurs at test time to inform the user that some parameters have changed.</p>
<p><b>Calibration FM Rate changed from...</b> This warning informs user of an automatic change in FM Rate for the Reference Oscillator or Calibration Source. The message occurs at test time to inform the user that some parameters have changed.</p>
<p><b>Currently stored caldata files will be overwritten. This can be circumvented by using another disc...</b> If data disc includes files CALDATA LO &amp; CALDATA HI, they will be overwritten. New calibration data may be recorded on a separate, initialized disc if it is desired to retain old caldata files.</p>
<p><b>Entered VCO Tune Const. changed from...</b> This warning informs user of an automatic change in the VCO Tuning Constant for the Reference Oscillator or Calibration Source. The message occurs at test time to inform the user that some parameters have changed.</p>
<p><b>Loaded Data is not compatible with current graph type.</b> The data you loaded does not correspond to the current type of graph. Plotting may give unexpected results.</p>
<p><b>RF Analyzer accuracy worse than 5 dB.</b> This warning appears during the calibration of an RF Analyzer. The difference in amplitude measurements between the HP 3561A and the RF Analyzer is &gt;5 dB when measuring the same 100 kHz calibration tone.</p> <p><b>Action:</b> Verify the proper operation of the RF Analyzer and HP 3561A using the appropriate calibration procedures discussed in their own calibration manuals.</p>
<p><b>Specified test-span not encompassed by currently defined segments...</b> The user tried to perform a measurement for which his segment table does not contain defined segments.</p> <p><b>Action:</b> Check the Plotted Ranges in the Segment Table against the offset frequency range specified for the test.</p>



**Table 8-4. Warning Messages**

**SYSTEM UNINITIALIZED. PROPER OPERATION UNLIKELY...** The system is unable to find the default files. Make sure the System Data Disc is in the correct mass storage location.

**Action:** Press **System Preset** to initialize and load the required files. Make sure the System Data Disc is in the correct Mass Storage location.

**(instrument) is not responding...**

**Action:** Check that the correct HP-IB addresses have been entered into the System Configuration Table. Also check that the instrument is connected via HP-IB, and that its power is ON.

**(instrument) is an unsupported (source, analyzer, etc...)** The system does not support this instrument, and the instrument is configured in the System Configuration Table.

**Table 8-5. Status Messages (1 of 11)**

**Acceptable 'Tuning Range' for this 'Center Voltage':** The system has automatically adjusted the Voltage Tune Range for the VCO to within acceptable limits. This is often due to the Tune Voltage Range limitation imposed by a Center Tune Voltage that is not equal to zero volts.

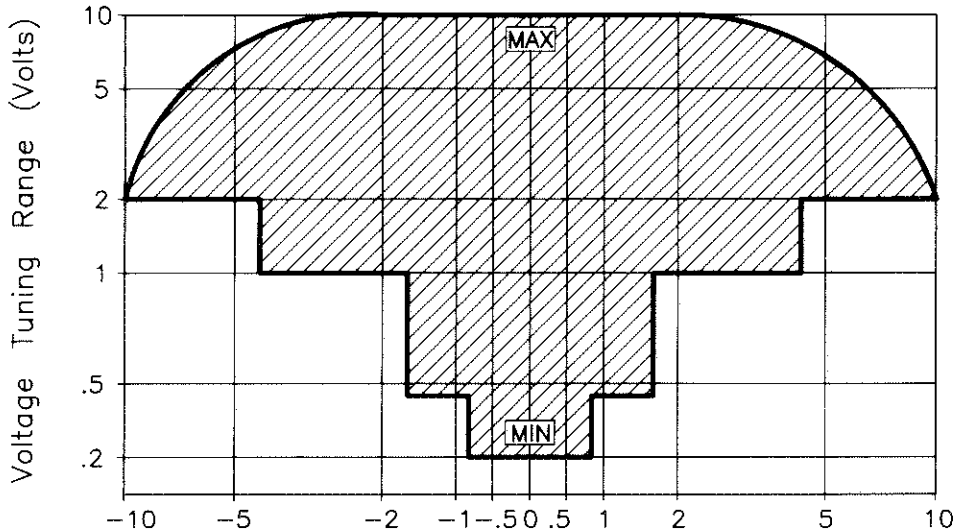

Center Voltage of VCO Tuning Curve (Volts)

$$|\text{Center Voltage}| + |\text{Voltage Tuning Curve}| \leq 12\text{V}$$

**ADJUST 3585A TRACKING GENERATOR FOR MAXIMUM LEVEL...** The level from the tracking generator is inadequate for the measurement.

**Action:** Turn the HP 3585A tracking generator knob fully CW and verify that the tracking generator output is connected to the correct HP 11848A Input.

**Apply modulation to carrier...** This is required for the Single Sided and Double Sided Spur and FM Rate and Deviation calibration techniques.

**Action:** Apply the modulation signal to the carrier.

**Table 8-5. Status Messages (2 of 11)**

**Approx internal noise floor (LNA in, Offsets > 10 kHz: dBc/Hz...** The Detector Constant and LNA determine the System Noise Floor.

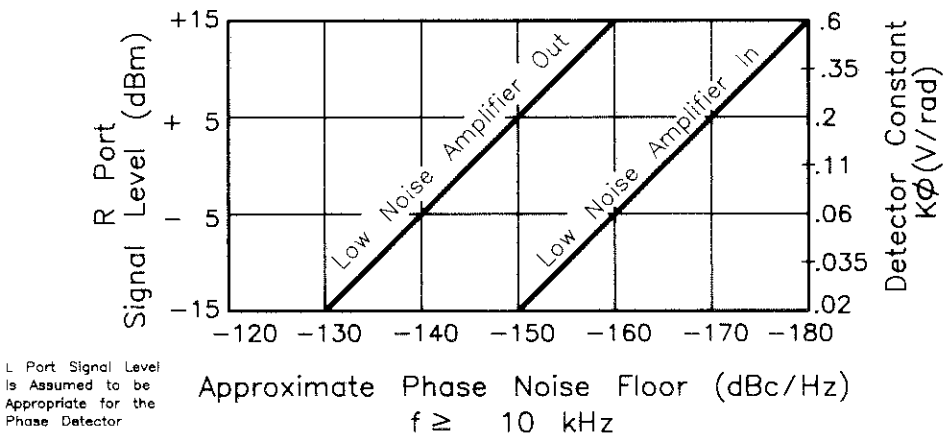

**Automatically establishing quadrature...** The system is establishing quadrature.

**Beatnotes: f1, f2, f3, f4...** Beatnote frequencies for -45%, -15%, +15%, and +45% of the Tuning Range around the Center Voltage are shown in conjunction with the non-linear Tuning Constant error.

**Action:** Correct the Tuning Constant error by finding a linear region in the center of the VCO Tuning Curve (Refer to Error Message 7).

**Table 8-5. Status Messages (3 of 11)**

<p><b>Calibrating the RF Level of HP XXXXX RF ANALYZER;...</b> The system measures the amplitude of a 100 kHz tone with both the RF Analyzer and the HP 3561A. This insures consistency between the two analyzers at 100 kHz.</p>
<p><b>Cause FIRST calibration PEAK voltage at mixer...</b> During calibration of the Phase Detector, the user is required to adjust the dc output of the phase detector to its maximum and minimum peak.</p> <p><b>Action:</b> Adjust frequency or phase angle to drive the phase detector output to the positive or negative peak.</p>
<p><b>Cause SECOND calibration PEAK voltage at mixer...</b> During calibration of the Phase Detector, the user is required to force the dc output of the phase detector to its maximum and minimum peak.</p> <p><b>Action:</b> Adjust frequency or phase angle to drive the phase detector output to the opposite peak.</p>
<p><b>Checking for HP3561A Noise Source...</b> The noise source is being tested for proper output level using the Performance Test technique described in the HP 3561A Service Manual. The system also checks path attenuation in the HP 11848A.</p>
<p><b>Checking for overload...</b> The system verifies that an overload condition does not exist when in the Noise Monitor Mode.</p>
<p><b>Checking the PLL...</b> The system verifies that the system is still phase locked.</p>
<p><b>CLEARING 0 TO 100 kHz. CALIBRATION DATA...</b> This does not affect calibration data stored on Mass Storage Media.</p>
<p><b>CLEARING 100 kHz. TO 40 MHz. CALIBRATION DATA...</b> This does not affect calibration data stored on Mass Storage Media.</p>
<p><b>CLEARING AUXILIARY 100 kHz. TO 40 MHz. CALIBRATION DATA...</b> This does not affect calibration data stored on Mass Storage Media (for caldata generated from Flatness Performance Test).</p>
<p><b>Closing the Phase Lock Loop...</b> This message notifies the user that the system is in the process of closing the phase lock loop.</p>

**Table 8-5. Status Messages (4 of 11)**

<p><b>Creating disk file:</b> The system is creating new 'MEDIA_ID' file</p>
<p><b>Crunch...</b> The system is performing an integration. Depending on controller speed and limits of integration this may take several minutes (2 to 20).</p>
<p><b>CURRENT (cal path) (PLEASE BE PATIENT)...</b> This message indicates that a calibration path in HP 11848A is being characterized. This takes approximately 3 minutes.</p>
<p><b>Deleting ! (directory / index)...</b> The system is deleting a file.</p>
<p><b>Determining Presence of a Beat Note...</b> The system is checking the Peak Detector for a dc voltage indicating a beatnote.</p>
<p><b>DEFAULT DRIVE IS:</b> This part of the 'Auto load' routine instructs the user where to install the software disk.</p> <p><b>Action:</b> Insert the correct disc into the location defined.</p>
<p><b>Enter Amplitude and FM Rate of spur</b></p> <p><b>Action:</b> Enter the amplitude (Peak Frequency Deviation) and the FM Rate (Modulation Frequency or Rate) of the Calibration Modulation.</p>
<p><b>Establish quadrature manually...</b> The system is unable to automatically establish quadrature.</p> <p><b>Action:</b> If possible, manually adjust frequency or phase to achieve quadrature (<math>0 \pm 1</math> division on HP 11848A Interface Quadrature Meter).</p>
<p><b>Establishing 785 Hz. beatnote...</b> The HP 11848A internal 10 MHz sources are offset by 785 Hz during spur calibration (Spur Accuracy Test) to prevent extraneous signals from appearing when Phase Modulation sidebands are impressed on 10 MHz source.</p>
<p><b>Evaluating flatness of measured noise segments...</b> The system informs the user that an evaluation is in progress.</p>
<p><b>Finding spurs...</b> The system is searching and recording the amplitude and frequency of the spurs within the data currently in memory.</p>
<p><b>Finding the calibration spur...</b> The system is measuring and recording the calibration spur level.</p>

**Table 8-5. Status Messages (5 of 11)**

<p><b>Generating theoretical loop suppression...</b> The system is fitting the theoretical response generated from the calibration data and entered parameters to the measured response of the loop suppression.</p>
<p><b>HP11848A INTERNAL ADJUSTMENTS...</b> Indicates which adjustment is under test.</p> <p><b>Action:</b> Follow operation prompts, which appear in the display.</p>
<p><b>Illegal X,Y ranges specified...</b> The graph parameters defined in the Define Graph display are out of sequence.</p> <p><b>Action:</b> Redefine the values such that <math>X\text{-min} &lt; X\text{-max}</math> and <math>Y\text{-min} &lt; Y\text{-max}</math>.</p>
<p><b>Initializing. One moment please...</b> Indicates that the HP 3048 is setting up the instruments for the measurement.</p>
<p><b>LAG/LEAD...</b> Indicates which Lag/Lead number is currently switched in during the functional check.</p>
<p><b>Loading 11848A calibration data...</b> CALDATALO and CALDATAHI are being retrieved from the mass storage media.</p>
<p><b>Manipulating FFT data...</b> The system is removing the spurs and processing the data from the selected Result Files.</p>
<p><b>Manipulating RF data...</b> The system is removing the spurs and processing the data from the selected Result Files.</p>
<p><b>Marker not within defined measurement span...</b> The Marker position for the currently defined span in Noise Monitor Mode is outside of the Plotted Range specified in the Segment Table.</p> <p><b>Action:</b> Move the Marker or select the appropriate span and press TAKE SWEEP. If the appropriate SPAN is not available in the Segment Table, the table must be modified to include the desired Plotted Range.</p>
<p><b>Measuring PLL suppression...</b> When Verification of the Loop Suppression is selected, the system locks the phase lock loop, injects noise into the loop, and then measures the response of the loop.</p>

**Table 8-5. Status Messages (6 of 11)**

<p><b>Measuring reference trace...</b> This message indicates that a reference path for a transfer function measurement is in progress (Functional Checks).</p>
<p><b>Measuring the Phase Detector Constant...</b> Measuring the Phase Detector Constant is part of measurement calibration.</p>
<p><b>NO MARKED SPURS FOUND IN SPECIFIED RANGE...</b> The system was unable to detect any spurs in the specified range.</p>
<p><b>No Measurement Calibration is needed for the following measurement type: Noise Measurement Using HP3561A only, and (Baseband Noise)...</b> Calibr Process is not applicable for the measurement type selected.</p>
<p><b>NON-CLEARABLE SRQ EXISTS ON...</b> The Controller is unable to clear an SRQ on an instrument. (Often caused by placing the HP 3561A into free-run, auto trigger mode.)</p> <p><b>Action:</b> Abort the measurement and press PRESET on the HP 3561A.</p>
<p><b>NOTE: A blank field refers to the currently defined 'MASS STORAGE IS' device...</b> A reminder that lack of an MSUS causes the system to look for files at the default drive location.</p>
<p><b>No test-result data exists in memory...</b> The Computed Outputs functions are performed on the result data currently in memory.</p> <p><b>Action:</b> Load the desired Result File, or perform a New or Repeat Measurement.</p>
<p><b>Offset the source and reference signals by at least 1 Hz and not more than 1 or 20 MHz, or 100 kHz. Press proceed when ready...</b> This is a prompt for the beatnote calibration method.</p> <p><b>Action:</b> Adjust the sources to obtain an offset frequency of <math>\geq 1</math> Hz and <math>\leq 100</math> kHz (or 20 MHz if an RF analyzer is being used).</p>
<p><b>One moment please...</b> The system is averaging the data taken for the low frequency spans.</p>
<p><b>Over-writing ( )...</b> The System is saving the file under the same name.</p>
<p><b>Phase Det. Constant:</b> Momentary display of the Phase Detector Constant determined in the measurement calibration.</p>

**Table 8-5. Status Messages (7 of 11)**

<p><b>Phase lock has been lost. Press 'Proceed' to attempt to re-lock the loop...</b> Phase lock was lost during the Phase Lock Loop measurement,</p> <p><b>Action:</b> Select <input type="button" value="Proceed"/> (if you wish to continue the measurement) or <input type="button" value="Abort"/> to stop.</p>
<p><b>Place (next disc) into the drive.</b></p> <p><b>Action:</b> Load the HP 3048A System Software.</p>
<p><b>Place the disk containing the file 'SYS_TESTS' into the default disc drive...</b> The 3048A Sys Chk requires a program within the 'Sys_Tests', and the system could not find it in memory.</p> <p><b>Action:</b> Insert (Sys_Test) HP 3048A software disc into the disc drive and press <input type="button" value="Proceed"/> .</p>
<p><b>PLEASE BE PATIENT...</b> The system is in the process of making a 1 Hz Low Pass Filter calibration which takes approximately 3 min.</p>
<p><b>Plotting curve-fit corrections...</b> This message informs the user that the system is processing the curve-fit corrections.</p>
<p><b>Pre adjustment check #1...</b> The system is performing the part of A4R51 adjustment that checks the HP 11848A Noise Input.</p>
<p><b>Pre adjustment check #2...</b> The system is performing the part of the A4R51 adjustment that checks the HP 11848A Noise Input with internal 60 MHz Low Pass Filter switched into the input path.</p>
<p><b>Preparing for calibration...</b> The System is being preset for calibration.</p>
<p><b>Pre-setting HPXXXX...</b> The System is setting up the specified instrument.</p>
<p><b>Pre-setting INTERNAL...</b> The System is setting up the HP 11848A Internal Oscillator.</p>
<p><b>RANGE IS UNACCEPTABLE...</b> The specified measurement range has a Start Frequency greater than or equal to the Stop Frequency.</p> <p><b>Action:</b> Re-define the Measurement Range.</p>
<p><b>Remove (previous disc) from the drive.</b></p> <p><b>Action:</b> Load the HP 3048A System Software.</p>



**Table 8–5. Status Messages (8 of 11)**

<p><b>Returning to 'Main Software Level'...</b> The System gave-up and re-booted itself.</p> <p><b>Action:</b> Verify that the measurement parameters are correctly defined for the measurement.</p>
<p><b>RF SPECTRUM ANALYZER MODEL HP3585A REQUIRED...</b> An HP 3585A/B is required for calibration of the HP 11848A from 100 kHz to 40 MHz.</p> <p><b>Action:</b> Verify that the HP 3585A/B is correctly connected to the HP-IB interface, and that it is listed in the System Configuration Table. (Other RF analyzers supported by the HP 3048A can be used to update the calibration files if an HP 3585A is not available. Refer to <i>RF Analyzers</i> in Chapter 6, System Configuration for a list of supported RF Analyzers.)</p>
<p><b>Selecting the LNA...</b> The System is determining if the Low Noise Amplifier is required.</p>
<p><b>Setting up for A4C32 adjustment...</b> The System is processing part of the internal adjustment.</p>
<p><b>Setting up HP 11848A for A4R51 Adjustment...</b> The System is processing part of the Internal Adjustment.</p>
<p><b>Setting up measurement configuration...</b> The System is configuring the instruments and/or the HP 11848A internal paths for the measurement.</p>
<p><b>Solving for (Osc unknown)...</b> The System is computing the noise of a source.</p>
<p><b>Solving for Osc_A,B,or C...</b>The system is computing the noise of each of the sources.</p>
<p><b>Sorting config table...</b> The System is alphabetizing the entries in the System Configuration Table.</p>
<p><b>Span too narrow. Cannot integrate...</b> The specified Range of Integration is not great enough to span a bin of the noise trace.</p> <p><b>Action:</b> Increase the specified Range of Integration.</p>
<p><b>Storing HP 11848A calibration data to disc at ( )...</b> This message indicates that a disc write operation is in progress for the Calibration Data.</p>
<p><b>Storing System Configuration...</b> This message indicates that a disc write operation is in progress for the system configuration.</p>

Table 8-5. Status Messages (9 of 11)

<p><b>SYSTEM OPERATING IN PULSE MODE. ESTABLISH QUADRATURE VIA AUX. MONITOR PORT...</b> The PULSED Carrier Type was selected and the system cannot verify quadrature or establish quadrature automatically.</p> <p><b>Action:</b> Use an oscilloscope connected to the HP 11848A Aux Monitor Port to achieve quadrature (dc). Refer to <i>Carrier Type</i> in Chapter 5, Special Functions for Information on establishing quadrature with a Pulsed Measurement.</p>
<p><b>Taking (RF_Model) sweep...</b> This message indicates that the System is performing a measurement.</p>
<p><b>Taking HP 3561A sweep...</b> This message indicates that the System is performing a measurement.</p>
<p><b>TEST PATH: REFERENCE PATH...</b> Indicates which HP 11848A internal path is being used for a reference measurement in a transfer function measurement.</p>
<p><b>The FM Deviation on the ( ) will be changed from (X) to (Y). If this is unacceptable, press 'Abort'...</b> During auto zerobeat of sources, the reference source frequency changed invalidating the FM Deviation setting specified for it.</p> <p><b>Action:</b> Press <input type="button" value="Proceed"/> or <input type="button" value="Abort"/>.</p>
<p><b>The LNA is currently (in/out) This may be changed via the 'Toggle LNA' key...</b> When PULSED is selected for the 'Carrier Type' in the Special Function Menu, a 'Toggle LNA' key will appear in some screens to allow the user to select between having the LNA in or out. If the system has decided to switch OUT the LNA and you are concerned about measurement sensitivity, you may wish to further evaluate the decision. Connect an oscilloscope to the AUX Monitor Port on the HP 11848A. Observe the LNA output and toggle the LNA IN. If the peak output level exceeds <math>-0.5V</math> or <math>+1V</math>, the noise may be clipped or compressed so the measurements must be made with the LNA OUT. If the noise is not significantly clipped, the measurement may be made with the LNA IN.</p>
<p><b>The LNA of the HP11848A has been bypassed. This will result in a degradation of the system noise floor...</b> This is a status message indicating a high input level into HP 11848A. If you wish to further evaluate the LNA decision, abort the measurement and access the Special Functions display. Select the PULSED Carrier Type and then initiate a Repeat Measurement. When the LNA decision is displayed again, connect an oscilloscope to the AUX Monitor port or the HP 11848A. Observe the LNA output and toggle the LNA IN. If the peak output level exceeds <math>-0.5V</math> or <math>+1V</math>, the noise may be clipped or compressed so the measurements must be made with the LNA OUT. If the noise is not significantly clipped, the measurement may be made with the LNA IN.</p>
<p><b>The plotted data was derived from Two-oscillator or Three-oscillator comparison...</b> This message is shown as the parameter summary for a result that was computed, not measured.</p>

**Table 8–5. Status Messages (10 of 11)**

<p><b>The system was trying to access the following file when the error occurred:</b> This is the standard filer error message.</p> <p><b>Action:</b> Correct the problem and then continue.</p>
<p><b>Timed-out setting ( ) on the...</b> The System attempted to address an instrument, but the instrument did not respond.</p> <p><b>Action:</b> Access the System Configuration Table and confirm that the correct HP-IB addresses have been entered and that the instrument is responding.</p>
<p><b>Timed-out reading the ( )...</b> The System attempted to address an instrument but the instrument did not respond.</p> <p><b>Action:</b> Access the System Configuration Table and confirm that the correct HP-IB addresses have been entered and that the instrument is responding.</p>
<p><b>Unable to Automatically Zero Beat the sources. Establish a beatnote less than or equal to ( ) Hz...</b> The System was unable to adjust the beatnote to within 5% of the Peak Tuning Range.</p> <p><b>Action:</b> Adjust the source frequency until the beatnote is within 5% of the PTR.</p>
<p><b>Unable to integrate over non-contiguous data...</b> Segments of the data are missing within the specified Integration Range.</p> <p><b>Action:</b> Verify the Segment Table ranges and remeasure the device across the entire desired integration range.</p>
<p><b>Updating file directory...</b> The System is modifying the directory within the mass storage media.</p>
<p><b>Use KNOB or ARROW KEYS to locate desired HP11848A internal path.</b></p> <p><b>Action:</b> The user selects these keyboard controls to make selections from a menu.</p>
<p><b>Use KNOB or ARROW KEYS to locate desired test.</b></p> <p><b>Action:</b> The user selects these keyboard controls to make selections from a menu.</p>
<p><b>VCO Tuning Constant:</b> This message momentarily displays the measured VCO Tuning Constant.</p>
<p><b>Verifying phase lock...</b> The System is checking for the present of a beatnote on an out-of-lock condition.</p>

**Table 8-5. Status Messages (11 of 11)**

<p><b>Verifying Quadrature...</b> The System is checking the dc level out of the Phase Detector.</p>
<p><b>Verifying system configuration...</b> The System is checking for a response from the instruments entered in the System Configuration Table.</p>
<p><b>Verifying zero-beat...</b> The System is checking that the beatnote is within 5% of the Peak Tuning Range.</p>
<p><b>WAITING FOR DAC TO SETTLE FOR...</b> This message indicates that part of Test 07, 10 MHz Source Beatnote Pull Check, is in process. The DACs require time to settle to the programmed voltage.</p>
<p><b>WAITING FOR DAC1 SETTLING...</b> This message indicates that part of the DAC1 adjustment is in process. The DAC requires time to settle to the programmed voltage.</p>
<p><b>Waiting for DAC2 settling...</b> The System is allowing time for the DAC to settle to the programmed voltage.</p>
<p><b>Waiting for DAC3 settling...</b> The System is allowing time for the DAC to settle to the programmed voltage.</p>
<p><b>Zero beating sources...</b> The System is automatically tuning the VCO to create a beatnote that is within 5% of the Peak Tuning Range.</p>
<p><b>(name) is an invalid NAME...</b> The System Configuration Table does not support the instrument as entered.</p> <p><b>Action:</b> Refer to the System Configuration Table HELP text for valid instrument names. (Note that Counter &amp; Voltmeter are supported names although they do not appear in the Help Text.)</p>
<p><b>(pathname) was not accessible...</b> System tried to re-store or write the file 'MEDIA_ID' at the location specified in the Mass Storage Table for 'Location of this Table.'</p> <p><b>Action:</b> Redefine the Mass Media Table or configure a Mass Storage device at this location.</p>
<p><b>(pathname\$) was not found...</b> System tried to load or read the file 'MEDIA_ID' from the location specified in the Mass Storage Table for 'Location of this Table.'</p>

# Index

---

0.001 Hz offset measurements, 5–20  
1 Hz bandwidth, 4–15  
2 device comparison, *see*: 2 Osc. Compar.  
2 Osc. Compar., 4–23  
2 oscillator comparison, *see*: 2 Osc. Compar.  
2 source comparison, *see*: 2 Osc. Compar.  
3 device comparison, *see*: 3 Osc. Compar.  
3 Osc. Compar., 4–19  
3 oscillator comparison, *see*: 3 Osc. Compar.  
3 source comparison, *see*: 3 Osc. Compar.  
10 MHz A used with HP 8662A/63A, 6–11, 6–13  
10 MHz B used with HP 8662A/63A, 6–14  
11848A Control, 5–35  
3048A Sys Chk, 5–43

## A

---

A vs. B file, 4–21, 4–25  
A vs. C file, 4–21  
absolute system noise floor HP 11729C, 6–35  
acc’y spec degrad, 2–54, 3–9  
Access Graph, 5, 3–1  
accuracy, 1–12. *see also*: specifications  
accuracy specification degradation, 2–54, 3–9  
adjustments (HP 11848A), 5–44. *see also*: HP 3048A Calibration Manual  
advanced user, 5–1  
Allan Variance, 4–10  
AM calibration, equivalent  $k_{\Phi}$ , 4–89, 7–12

- AM Detector, 2-8, 2-89, 6-63
  - Constant, 2-89
  - filter, 6-63
- AM measurements HP 11729C, 6-43. *see also*: HP 3048A Operating Manual
- AM Noise,
  - instrument parameter, 2-38
  - calibration process, 2-89
  - measurement type, 2-7
- AM rejection, 2-7
- AM sensitivity, 2-89
- amplifiers, 2-6, 6-64
- assumed pole, 2-55, 3-11, 5-5
- ATTEN1, 5-37
- ATTEN2, 5-37
- ATTEN3, 5-37
- attenuators, 6-63
- Aux Monitor port, 2-46, 6-46
- averages,
  - FFT, 2-12, 5-15
  - span marking, 4-28
- averaging, 2-12, 5-15

## **B**

---

- BW, 4-16, 5-16, 5-26
- B vs. C file, 4-21
- backup software files, *see*: copying files
- bandwidth, 5-16, 5-26
  - 0 Hz, 4-17
  - normalized, 4-15
- baseband noise measurement type, 2-10
- beatnote, 2-46, 7-24. *see also*: HP 3048A Operating Manual
- beatnote calibration w/o PLL, 2-65
- bin, 4-5
- block diagram HP 11848A, 5-42

## C

---

- cal system, 7, 5-44. *see also*: HP 3048A Calibration Manual
- CALDATAHI, 5-45. *see also*: HP 3048A Calibration Manual
- CALDATALO, 5-45. *see also*: HP 3048A Calibration Manual
- Calibr Process, 2-41
- calibration,
  - constant, *see*: Phase Detector Constant; VCO Tuning Constant; Discriminator Constant, AM Detector Constant
  - data, *see*: HP 3048A Calibration Manual
  - periodic, *see*: HP 3048A Calibration Manual
  - process, 2-41
  - spur, *see*: double sided spur; single sided spur; spur test
  - tone, 6-25
- capture range, 7-14. *see also*: HP 3048A Operating Manual
- carrier frequency, 3-5, 3-15
  - AM Noise, 2-38
  - w/FM Discriminator, 2-35
  - w/PLL, 2-14
  - w/o PLL, 2-31
- carrier noise test set (HP 11729C), 6-32
- carrier type, 5-9
- center voltage, 2-17, 3-6, 7-16
- center voltage of VCO tuning curve, 2-17, 3-6, 7-16
- clearing CALDATA, 7, 5-46
- clip left, 3-26
- clip right, 3-26
- closed PLL bandwidth, 3-10, 5-5
- comb line frequencies, 6-33
- Computed Outputs, 4-1
- computers, 1-9, 6-49
- computer accessories, 1-9
- controllers, 6-49
- copying files, 6-52
  - test files, 2-124
  - result files, 3-15

- counters, 6-45
- couplers, 2-73, 6-64
- Create Dir. (create directory), 2-126, 3-18
- Current Detector Constant, 2-44
  - w/o PLL, 2-59
- Cutler, 4-11
- cutoff frequency ( $f_h$ ), 4-9
- CW Carrier Type, 5-9

## D

---

- DAC1, 5-37
- DAC2, 5-37
- DAC3, 5-37
- Dac tests, 5-44
- data files, 6-52. *see also*: test files; result files
- Data Type, 2-117, 4-4
- dBc/Hz, 4-16
- dc block, 2-8, 6-64
- DC FM,
  - HP 8662A/HP8663A, 2-29, 6-10
  - deviation, 2-16. *see also*: VCO Tuning Constant
- decr. hpf, 8, 5-30
- decr. lpf, 8, 5-30
- Default,
  - Test File, 2-122
  - Result File, 3-14
- Define Graph, 2-115, 3-19
- Define Msrmnt, 2-1
- Definite Integral Value, 4-3
- delay line discriminator, 2-79, 2-109, 7-10
- delete entry, 8, 4-4
- delete file, 2-123, 3-15
- delete segment, 5-19
- derive from measured +/- dc peak w/o PLL, 2-61
- Detect. Input Frq., 3-5. *see also*: Detector/Discr.



- Detector Constant, 3-7, 7-2. *see also*: Phase Detector Constant
  - estimating, 2-91, 7-2
  - w/PLL, 2-43
- detector selection,
  - AM Noise, 2-39
  - w/FM Discriminator, 2-37
  - w/PLL, 2-26
  - w/o PLL, 2-33
- Detector/Discr.,
  - Input Frequency AM, 2-39
  - Input Frequency FM Discriminator, 2-36
  - Input Frequency w/PLL, 2-15
  - Input Frequency w/o PLL, 2-32
- Device Under Test (DUT), 2-102, 3-11
- digital voltmeter, 6-47
- direct comparison, 4-19
- directional coupler, 2-73, 6-64
- directory, 2-126, 3-18
- disc drives, 1-10, 6-51
- discontinuity, *see*: HP 3048A Operating Manual
- discriminator (delay line), 2-79, 7-11
- discriminator sensitivity, *see*: Discriminator Constant
- Discriminator Constant, 2-75
  - estimating, 2-78
- display resolution for the HP 3561A, 5-17
- dividers, 2-6
- Documentation Update Service, 1-4
- documentation updating, 1-4
- Double Sided Spur,
  - calibration tone, 6-29
  - AM Noise, 2-93
  - w/FM Discriminator, 2-81
  - w/o PLL, 2-67
- down converter, 3-12, 6-31
- Drift Tracking Range, 2-19, 7-14

DUT, 2-102, 3-11  
DUT source, 2-108  
dynamic signal analyzer, *see*: HP 3561A

## **E**

---

EFC, 6-8, 7-18  
enhanced tuning range, 2-27, 7-18  
entered K\_VCO, 3-5. *see also*: VCO Tuning Constant  
erase lines, 3-26  
Error Messages, 8-2  
Eval Allan, 9, 4-10  
eval intgrl, 10, 4-4  
eval sigma, 10, 4-10  
external timebase, 3-11. *see also*: external reference tuning  
external controller, 6-2  
external detectors,  
    phase, 2-26  
    w/FM Discriminator, 2-37  
    w/PLL, 2-26  
    w/o PLL, 2-34  
external reference tuning, 6-12

## **F**

---

$f_h$ , 4-9  
F SWITCH NUMBER, 5-38  
FFT Analyzer, 6-2  
FFT Segment, 5-13  
FFT Segmnts, 5-13  
filters, 2-6, 6-63  
flicker of freq., 4-13  
flicker of phase, 4-13  
floppy disc, 6-51  
FM deviation, 2-16, 2-85. *see also*: VCO Tuning Constant  
FM discriminator calibration, 2-75  
FM rate, 2-85

FM rate and deviation calibration w/FM discriminator, 2-85  
FM spectral density, 2-117, 3-21  
Fnctl. Chk., 10, 5-44  
fractional frequency deviation, 4-9  
freeze files, 10, 4-21, 4-25  
frequency counter, 6-2, 6-45  
frequency fluctuations, 2-76  
frequency multipliers, 2-6  
frequency offset range, 1-3, 5-20  
frequency range, 1-12, 2-12, 5-25  
function generator, 6-2  
functional checks, 10, 5-44

## **G**

---

GAIN1, 5-37  
GAIN2, 5-37  
GAIN3, 5-37  
General Information, 1-1  
graph,

- AM calibration, equivalent  $k_{\Phi}$ , 7-12
- center voltage, 3-6, 7-16
- peak tuning range noise floor, 2-21, 7-28
- peak tuning range required, 2-23, 7-22
- phase lock loop bandwidth, 2-22, 7-24
- VCO tuning characteristics, 2-50, 7-18
- voltage controlled source tuning requirements, 2-19, 7-14

Graph Type, 2-117, 3-21  
Graphic Functions, 3-1

## **H**

---

H SWITCH NUMBER, 5-38  
hard copy, 10, 3-26  
hard disc, 6-51  
HEWLETT-PACKARD FACTORY (test file), 2-122  
HP 11729C, 1-19, 6-20, 6-31

HP 11729C specs, 4, 6-33  
HP 11808A, 6-61  
HP 11848A block diagram, 5-42  
HP 11848A Interface, 1-2, 5-35, 5-43  
HP 11848A LNA, 3-12, 5-9, 7-2  
HP 3048A, 1-2  
HP 3048A option K21, 2-8, 6-63  
HP 3048A reference source options, 1-7  
HP 3048A spectrum analyzer options, 1-8  
HP 3048A system options, 1-8  
HP 310, 6-49  
HP 320, 6-49  
HP 33330C low barrier schottkey diode detector, 2-91 6-63, 7-12  
HP 3561A dynamic signal analyzer, 1-2, 2-8, 5-13, 5-30  
HP 3585A/B, 6-24  
HP 5316A/B, 6-45  
HP 5343A, 6-45  
HP 5384A, 6-45  
HP 5385A, 6-45  
HP 5386A, 6-45  
HP 71000, 6-24  
HP 82315B, 6-49  
HP 8566A/B, 6-24  
HP 8567A, 6-24  
HP 8568A/B, 6-24  
HP 8642A, 6-16  
HP 8656B, 6-18  
HP 8656A, 6-19  
HP 8662A/HP 8663A, 6-7  
HP 9836A, 6-49  
HP 9836C, 6-49  
HP EXAMPLE (test file), 2-122  
HP-IB address, 6-0. *see also*: HP 11848A Service Manual  
HP TEST (test file), 2-122

## I

---

Ignore Out Of Lock Test Mode, 10, 5-8  
injection locking, 2-48, 2-56, 7-22. *see also*: HP 3048A Operating Manual  
Instr. Params, 2-13  
Instrument Parameters, 2-13  
Int. Adj'mt, 5-44. *see also*: HP 11848A Serv./HP 3048A Cal. Manuals  
Integr Noise, 4-3  
Integrated Noise, 4-3  
interface, *see*: HP 11848A  
isolation, 2-48

## J

---

Jitter, 4-29

## K

---

$k_d$ , *see*: Discriminator Constant  
K\_Detector method, 3-7  
known osc., 4-24  
 $k_\Phi$ , 2-43. *see also*: Phase Detector Constant  
kv [Hz/v], *see*: VCO Tuning Constant  
K\_VCO method, 3-8. *see also*: VCO Tuning Constant

## L

---

$\mathcal{L}(f)$ , 2-117, 3-21, 4-4  
lag-lead filter, 5-38, 7-22  
line stretcher, 2-61, 2-82, 2-108, 6-64  
LNA, 3-12, 5-9, 5-42, 7-2  
Load Alt., 11, 6-61  
load alternate program, 6-61  
load CALDATA, 11, 5-46  
load file, 11, 2-126, 3-14  
load file test file, 2-123  
lock loop, 11, 5-30

loop holding range, *see*: Drift Tracking Range  
loop suppression, 2-54, 3-9  
loop suppression verification, 2-54, 3-9  
Low Noise Amplifier, 3-12, 5-9, 5-42, 7-2

## **M**

---

maximum x coordinate, 3-20  
manual updates, 1-4  
Marker,  
    (RF Analyzer), 12, 5-31  
    3561A, 12, 5-31  
    ON/OFF, 12, 3-23  
mass storage, 2-123, 3-14, 6-51  
mass storage devices, 1-10, 6-51  
maximum acceptable clipping, 5-11  
maximum y coordinate, 3-20  
measure the detector constant w/PLL, 2-47  
measurement,  
    averages, 2-12, 4-28, 5-15  
    bandwidth, 5-16, 5-26  
    definitions, 2-1  
    FFT, 5-16  
    range, 2-12, 5-20  
    resolution, 5-14, 5-25  
    software, 1-2  
    time, 5-14  
    type, 2-4, 3-4  
Messages, 8-1  
    Numbered Error, 8-2  
    Reference, 8-21  
    Status, 8-29  
    Unnumbered Error, 8-19  
    Warning, 8-28  
meter, 2-49, 2-88  
meter sensitivity, 2-49, 2-88

mixer sensitivity, *see*: Phase Detector Constant  
modulation analyzer, 2-67, 2-93, 6-63  
move down, 3-26  
move up, 3-26  
multimeter, 6-47

## **N**

---

N, 4-9  
National Bureau of Standards Traceability NBS, 1-11  
new line, 3-26  
New Noise Monitor, 12, 5-30  
New Measurement, 12. *see also*: HP 3048A Operating Manual  
next page, 13, 3-14  
next type, 13, 2-4  
Noise, 4-17  
data plotted in a 0 Hz bandwidth, 4-17  
floor level w/PLL, 2-20, 7-28  
Input, 2-47  
power, 4-7  
Measurement Using the HP 3561A Only measurement type, 2-8  
voltage, 2-8, 2-10  
voltage measurements, *see*: baseband noise measurement type  
Noise Monitor, 5-29  
Noise Monitor/Newnoise Monitor, 5-29  
Normal Test Mode, 5-4  
Normalized Bandwidth, 4-15  
Non-linear Tuning Constant, 2-24

## **O**

---

offset frequency range, 1-12, 2-12, 5-20, 5-25  
Omit Spurs, 13, 4-4, 4-10  
One Osc., 4-21, 4-25  
Operator's Training, 1-2  
Option 001, 1-7  
Option 002, 1-7

Option 003, 1-7  
Option 004, 1-7  
Option 005, 1-7  
Option 006, 1-7  
Option 101, 1-8  
Option 110, 1-8  
Option 201, 1-8  
Option 202, 1-8  
Option 910, 1-8  
Out of Lock, 5-8, 6-48. *see also*: HP 3048A Operating Manual  
overload, 2-112, 6-48

## **P**

---

panel meter, 2-49, 2-84  
Param Summary, 3-3  
Parameter Summary, 3-3  
Parm\_Dir, 2-126  
Parm\_(number), 2-124  
peak deviation, 2-16. *see also*: VCO Tuning Constant  
peak phase deviation, 2-69  
peak tuning range, 2-18, 3-10  
    maximum HP 11729c, 6-41  
    noise floor, 7-28  
    required, 7-22  
peak volts, 2-61  
Perf. Tests, 14, 5-44, 6-29  
Performance Tests, 14, 5-44, 6-29  
performance verification capabilities, 5-43  
Phase Detector, 3-7  
    Constant w/PLL, 2-43  
    Constant w/o PLL, 2-57  
    sensitivity, *see*: Phase Detector Constant  
phase lock loop bandwidth, 2-18, 2-22, 7-24, 7-26  
phase lock loop suppression, 2-54, 5-4  
phase modulation spectral density, 2-117, 3-21



- Phase Noise,
  - of various HP sources, 6-3, 7-6
  - Using an FM Discriminator, 2-35
  - Using a Phase Lock Loop measurement type, 2-4
  - Without Using a PLL, 2-31
  - Without Using a PLL measurement type, 2-6
- phase shifter, 2-108, 6-64
- phase slope, 2-43, 3-7, 7-4. *see also*: Phase Detector Constant
- PLL BW, 2-23, 2-54, 7-24
- PLL suppression curve, 5-5
- Plot W/O Spurs, 14, 3-31, 3-32
- plot without spurs, 14, 3-31 3-32
- plotter, 6-2, 6-55
- plotters (outputting), 3-29
- plotter pens, 6-56
- power meters, 6-63
- power splitters, 6-64
- printer, 1-10, 6-2
- printers/plotters, 1-10, 6-55
- PTR, 2-18, 3-10, 7-22
- Pulsed Carrier Type, 5-9

## **Q**

---

- quadrature meter, *see*: meter
- Quick Reference, 7-1

## **R**

---

- Random Walk of Freq., 4-13
- Read Dir, 15, 2-123, 3-15
- real time, 5-29. *see also*: Noise Monitor
- real time noise measurements, 5-32
- reference line, *see*: specifications lines; slope lines
- Reference Messages, 8-21
- Reference Noise vs. DUT Noise, 7-8
- Reference Source, 3-11

region of validity, 7-4  
relation of  $\mathcal{L}(f)$  to Allan Variance, 4-13  
remove line, 16, 3-26  
repeat measurement, *see*: HP 3048A Operating Manual  
residual (two-port), 2-6  
resolution, 5-25  
resu\_, 3-15  
Result Files, 3-13  
return loss noise input, 2-49  
RF (spectrum) analyzer, 5-23, 6-2, 6-23, 6-25  
RF segment table, 5-24, 6-25  
RF segmnts, 5-23  
RF source, 6-2  
rms modulation, 4-3

## S

---

segment table, 5-23  
    increasing resolution, 5-21  
    measurement time, 5-19  
    specifying offsets, 5-22  
SELECTED K SWITCHES, 5-38  
SELECTED L SWITCHES, 5-38  
SELECTED S SWITCHES, 5-38  
Set Line, 3-26  
Sigma vs. Tau, 4-9  
signal level, 7-2  
single point, 5-29. *see also*: Noise Monitor  
Single Sided Spur,  
    calibration tones, 6-29  
    AM Noise, 2-97  
    w/o PLL, 2-71  
Single-Sideband Phase Noise, 2-117, 3-21, 4-4  
Slope Lines, 3-25  
slope versus maximum tau, 4-12  
small angle criteria, 2-87

small angle criteria  $\mathcal{L}(f)$ , *see*: region of validity  
 $s_{\nu}(f)$ , 2-117, 3-21, 4-4  
 Software Materials Subscription (SMS), 1-5  
 Software Notification Service (SNS), 1-5  
 Software Release Bulletin, 1-6  
 Software Status Bulletin, 1-6  
 Software Updating, 1-5  
 Solve A,B,C, 4-21  
 Solve for B, 4-25  
 Source Drift (*see* Drift Track Range), 2-19  
 span, 5-31  
 Spec Lines, 2-118  
 Special Functions, 5-1  
 Specifications, 1-11  
 Specification Lines, 2-118  
 Spectral Density,  
     of Fractional Frequency Fluctuations, 2-117, 3-21, 4-4  
     of Frequency Fluctuations, 4-4  
     of Phase Fluctuations, 4-4  
 spectrum analyzer, 1-10, 6-2  
     output HP 11848A, 6-29  
     phase detector output, 6-25  
 $S_{\Phi}(f)$ , 2-117, 3-21, 4-4  
 Spur List, 4-27  
 spur marking criteria, 4-28  
 Spur Test, 5-44. *see also*: HP 3048A Calibration Manual  
 SRB, 1-6  
 SRM, 6-51  
 SSB, 1-6  
 Start Offset Freq, 3-4  
 Status Messages, 8-29  
 Stop Offset Freq, 3-4  
 Store File, 2-125, 3-15  
 sweep time, 5-26  
 switch (*refer to* 11848A control), 5-35

$S_y(f)$ , 2-117, 3-21, 4-4  
System Config, 6-1  
System Clock, 6-59  
System Configuration, 6-1

## T

---

t, 4-9  
tau ( $\tau$ ), 4-9  
table of data points for supported analyzers, 4-6  
Take Sweep, 19, 5-31  
Test Files, 2-121  
    loading, 2-126  
    storing, 2-125  
Test Mode, 5-3  
Test Result File, 3-13  
Three Osc. Comparison, *see*: 3 Osc. Compar.  
Time Record Length, 5-17  
Title, 2-116, 3-20  
Troubleshooting, *see*: HP 3048A Cal./HP 11848A Serv. Manuals  
Trouble Shoot Test Mode, 5-4  
tune port input resistance, 2-18, 3-8  
tune port resist, 2-18, 3-8  
tune voltage output port on the rear panel, 2-17  
Tune Voltage Range, 2-17, 3-6  
Tune Voltage Rnge, 2-17, 3-6  
Tuning,  
    Constant, 2-50. *see also*: VCO Tuning Constant  
    Curve, *see*: VCO Tuning Constant  
    sensitivity, *see*: VCO Tuning Constant  
    slope, *see*: VCO Tuning Constant  
Two Osc. Comparison, *see also*: 2 Osc. Compar.  
Two Port (residual), 2-6  
Type/Range, 2-3

## U

---

uncal light, 6-29  
unmarked spurs, 4-22, 4-26, 4-28  
Unnumbered Error Messages, 8-19  
Update Dir, 2-123, 3-15

## V

---

$V/\sqrt{Hz}$ , 2-75  
V/Rad, 2-57  
VCO slope, *see*: VCO Tuning Constant  
VCO tune port input resistance, 2-18  
VCO Tuning Constant, 2-16, 2-50, 3-8, 5-8, 7-18  
VCO tuning linearity, 2-24  
Vectra Viper, 6-49  
video bandwidth, 5-26  
VNOMS, 5-45. *see also*: HP 3048A Calibration Manual  
Voltage Controlled Source Tuning Requirements, 7-14  
Voltage Tuning Range of VCO, 2-17  
Voltmeter, 6-2, 6-47  
VTR, 2-17

## W

---

Warning Messages, 8-28  
white freq., 4-13  
white phase, 4-13

## X

---

x coordinate, 2-116

## Y

---

y coordinate, 2-117